

A Complete Genealogy Report For

**JAMES KENNADAY**

Created on 20 February 2009  
"The Complete Genealogy Reporter"  
© 2006-2007 Nigel Bufton  
under license to MyHeritage Family Tree Builder



## CONTENTS

1. PATERNAL ANCESTRY.
2. MATERNAL ANCESTRY.
3. DESCENDANTS.
4. DIRECT RELATIONS.
5. INDIRECTLY RELATED via BETTY CAROL FITZPATRICK.
6. INDIRECTLY RELATED via JOHN DAVID KELLEY.
7. INDIRECTLY RELATED via BRUCE DOUGLAS WHITMAN.
8. INDIRECTLY RELATED via MABLE PIERCE.
9. INDIRECTLY RELATED via FRANCES ELIZABETH KENNEDY.
10. INDIRECTLY RELATED via ANNE ELIZABETH VAN ORSDEL.
11. INDIRECTLY RELATED via MARY ELIZABETH SKELTON.
12. INDIRECTLY RELATED via CRISTINE SAPP.
13. INDIRECTLY RELATED via BETTY EARLYWINE.
14. FAMILY TREES.
15. INDEX OF PLACES.
16. INDEX OF DATES.
17. INDEX OF INDIVIDUALS.

## 1. PATERNAL ANCESTRY

## 2. MATERNAL ANCESTRY

### 3. DESCENDANTS

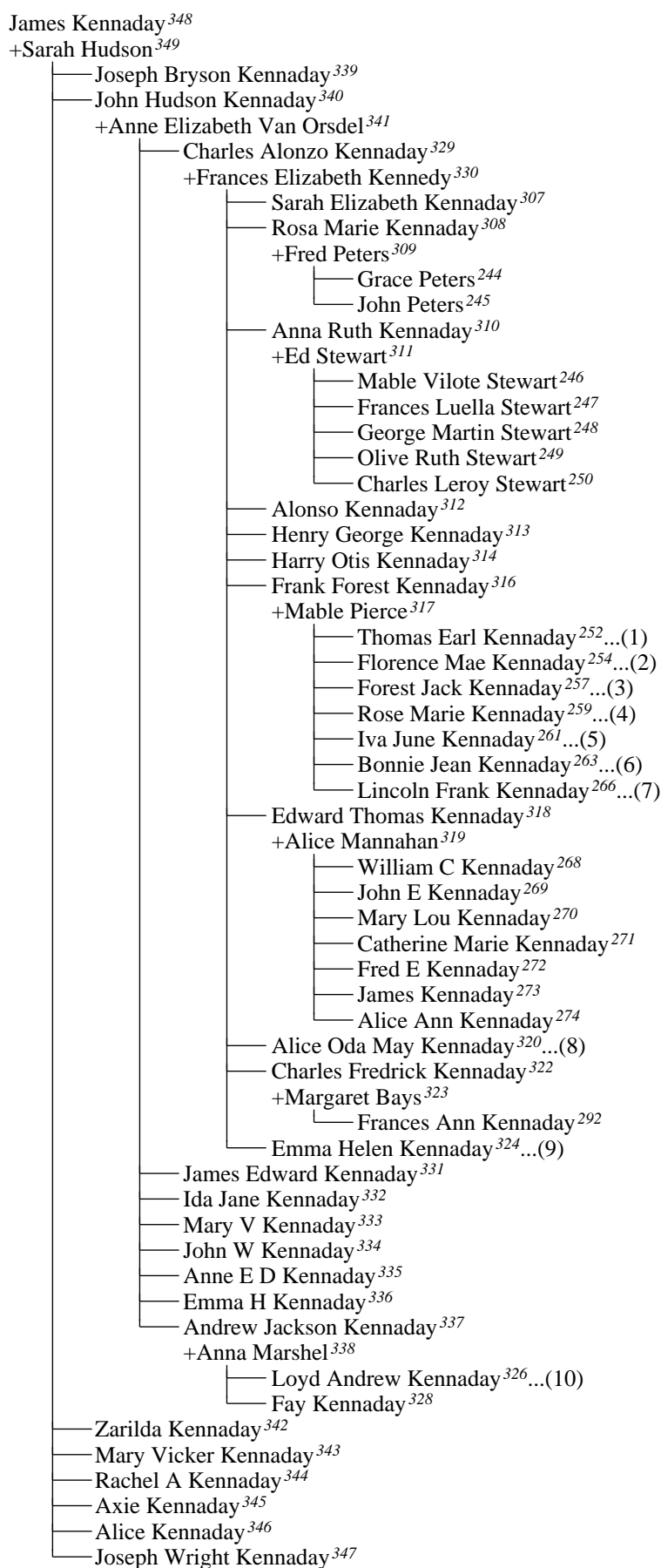

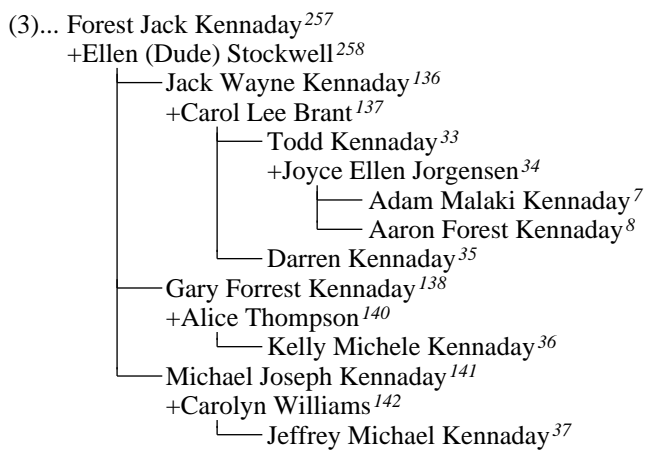
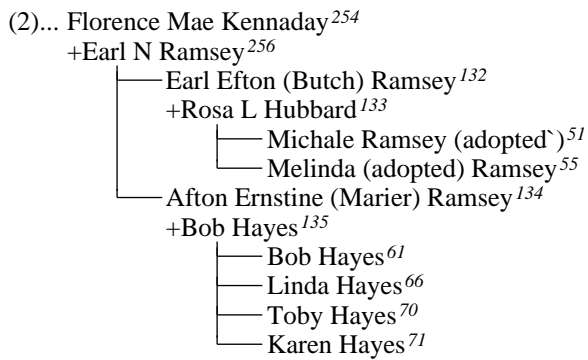
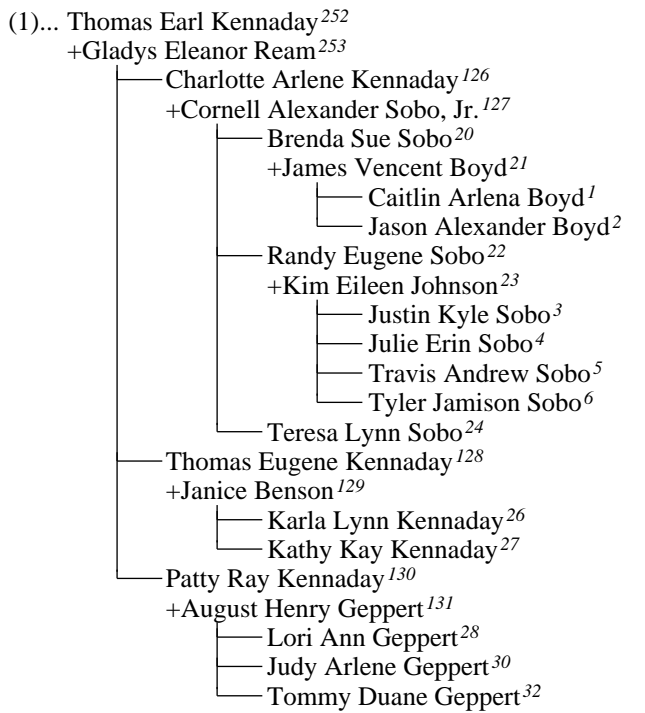

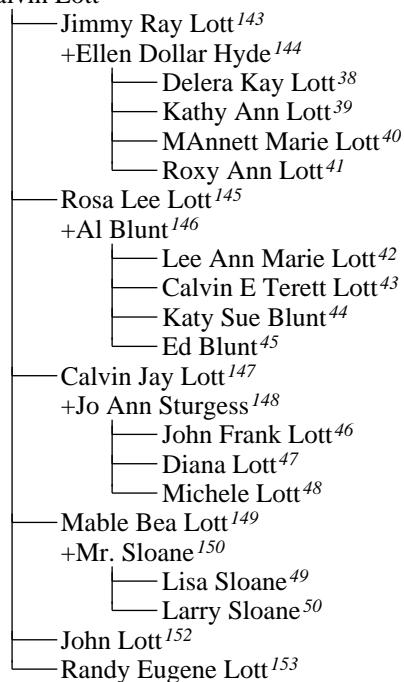
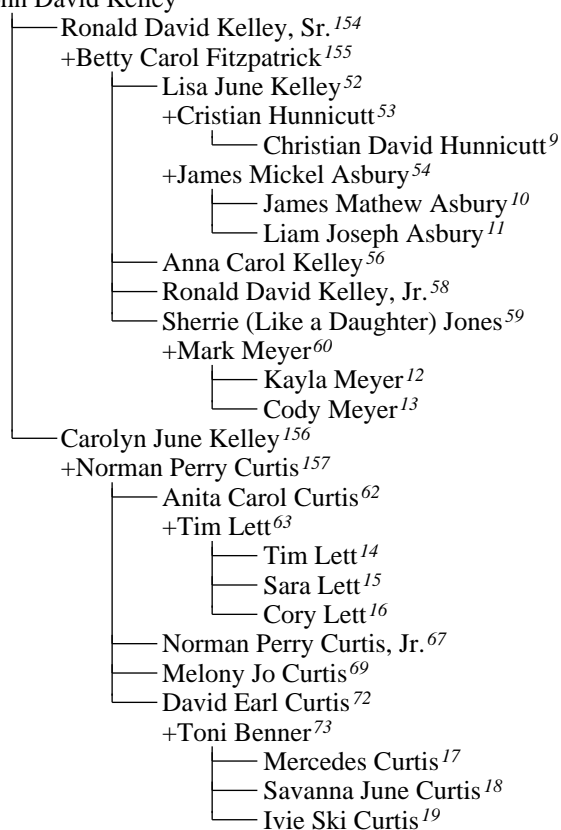
(4)... Rose Marie Kennaday<sup>259</sup>+Calvin Lott<sup>260</sup>(5)... Iva June Kennaday<sup>261</sup>+John David Kelley<sup>262</sup>

- (6)... Bonnie Jean Kennaday<sup>263</sup>  
 +Gordon Johnson<sup>264</sup>  
 └── Stanley Johnson<sup>158</sup>  
 └── Scott Johnson<sup>159</sup>  
 +James Martin Marier<sup>265</sup>  
 └── Sherry Jean Marier<sup>160</sup>  
 └── +Gordon Johnson<sup>162</sup>  
 └── Gordon Scott (Scotty) Johnson<sup>82</sup>  
 └── Stanley (Stan) Johnson<sup>83</sup>  
 └── Jane Marie Marier<sup>163</sup>  
 └── +Micheal A Forrester<sup>164</sup>  
 └── Mike Allen Forrester, Jr.<sup>84</sup>  
 └── Tommy James Forrester<sup>85</sup>  
 └── Jamie Forrester<sup>86</sup>
- (7)... Lincoln Frank Kennaday<sup>266</sup>  
 +Joan Olivia Debernardi<sup>267</sup>  
 └── Gary Jo Kennaday<sup>165</sup>  
 └── David Debernardi Kennaday<sup>167</sup>  
 └── +Paula Jo Smith<sup>168</sup>  
 └── Nicholas Isaiah Kennaday<sup>74</sup>  
 └── Elizabeth Alta Olivia Kennaday<sup>75</sup>  
 └── Cristina Dianne Kennaday<sup>76</sup>  
 └── Steven Scott Kennaday<sup>169</sup>  
 └── +Catherine Susan Lavelle<sup>170</sup>  
 └── Joshua Jolin Kennaday<sup>77</sup>  
 └── +Danielle Reed<sup>171</sup>  
 └── Mallory Kennaday<sup>78</sup>  
 └── Reed Kennaday<sup>79</sup>  
 └── Fredrick Frank Kennaday<sup>172</sup>  
 └── +Brigid Ann Young<sup>173</sup>  
 └── Patricia Leigh Kennaday<sup>80</sup>  
 └── Anthony Joseph Kennaday<sup>81</sup>



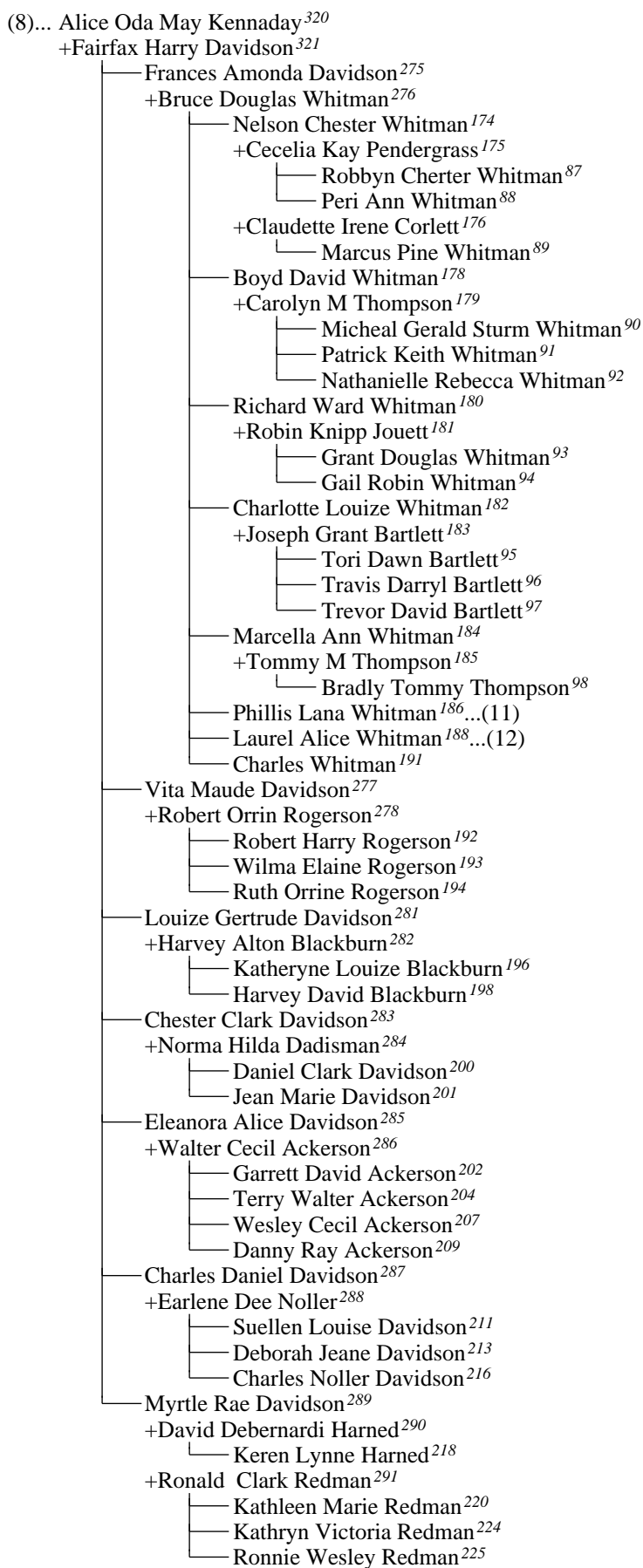

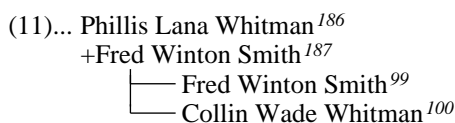
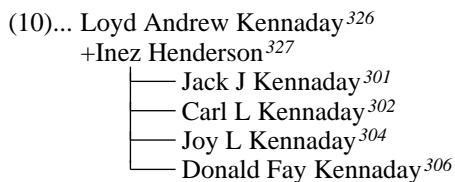
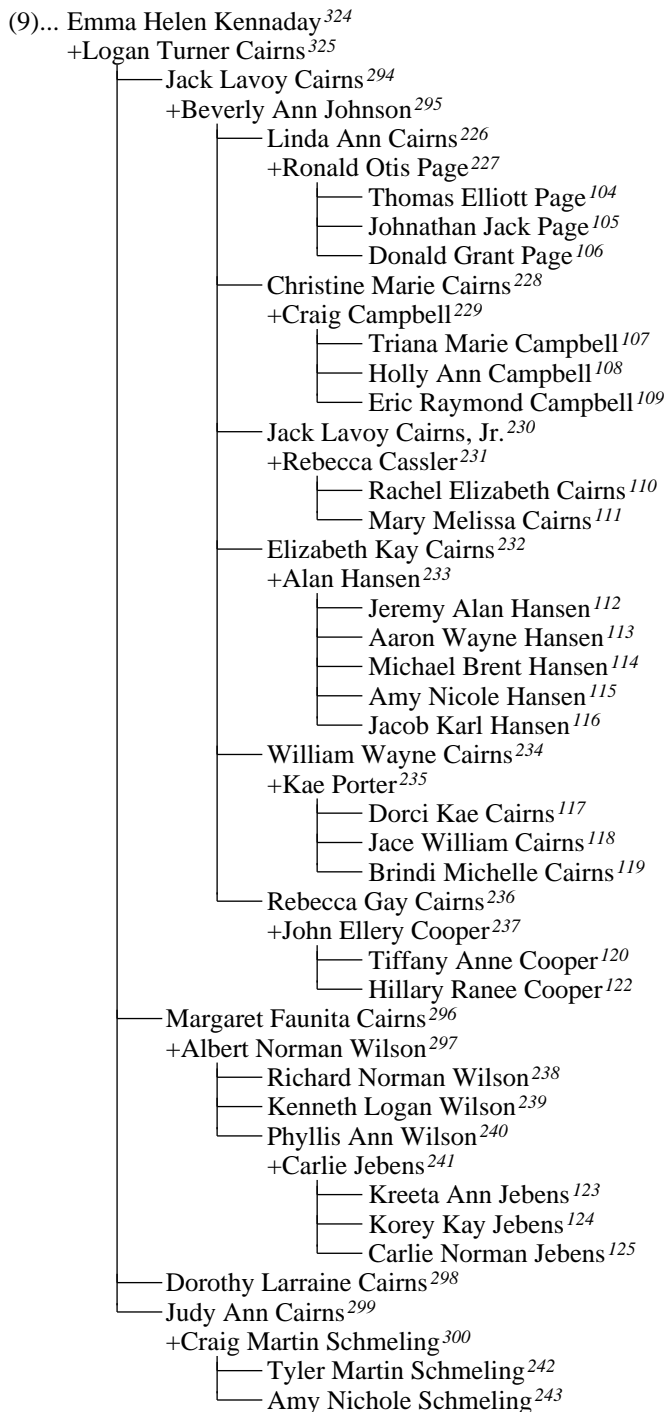

(12)... Laurel Alice Whitman<sup>188</sup>  
+Stanley Howard Self<sup>189</sup>  
├— Stuart Branson Self<sup>101</sup>  
├— Ian Mathew Self<sup>102</sup>  
└— Ashley Chester Self<sup>103</sup>

## 4. DIRECT RELATIONS

### Generation of Five-Times-Great-Grandchildren

1. CAITLIN ARLENA BOYD (James's five-times-great-granddaughter) was born in 1992 in Managua, Nicaragua to James Vencent Boyd<sup>21</sup> and Brenda Sue Sobo<sup>20</sup>, as shown in family tree 1.
2. JASON ALEXANDER BOYD (James's five-times-great-grandson) was born in 1994 to James Vencent Boyd<sup>21</sup> and Brenda Sue Sobo<sup>20</sup>, as shown in family tree 1.
3. JUSTIN KYLE SOBO (James's five-times-great-grandson) was born in 1982 in Medford, Jackson, Oregon, USA to Randy Eugene Sobo<sup>22</sup> and Kim Eileen Johnson<sup>23</sup>, as shown in family tree 2.
4. JULIE ERIN SOBO (James's five-times-great-granddaughter) was born in 1985 in Medford, Jackson, Oregon, USA to Randy Eugene Sobo<sup>22</sup> and Kim Eileen Johnson<sup>23</sup>, as shown in family tree 2.
5. TRAVIS ANDREW SOBO (James's five-times-great-grandson) was born in 1987 in Medford, Jackson, Oregon, USA to Randy Eugene Sobo<sup>22</sup> and Kim Eileen Johnson<sup>23</sup>, as shown in family tree 2.
6. TYLER JAMISON SOBO (James's five-times-great-grandson) was born in 1987 in Medford, Jackson, Oregon, USA to Randy Eugene Sobo<sup>22</sup> and Kim Eileen Johnson<sup>23</sup>, as shown in family tree 2.
7. ADAM MALAKI KENNADAY (James's five-times-great-grandson) was born in 1987 in Anaheim, Orange, California, USA to Todd Kennaday<sup>33</sup> and Joyce Ellen Jorgensen<sup>34</sup>, as shown in family tree 3.
8. AARON FOREST KENNADAY (James's five-times-great-grandson) was born in 1990 in Anaheim, Orange, California, USA to Todd Kennaday<sup>33</sup> and Joyce Ellen Jorgensen<sup>34</sup>, as shown in family tree 3.
9. CHRISTIAN DAVID HUNNICUTT (James's five-times-great-grandson) was born on 10 January 1983 in Indianapolis, Indiana, USA to Cristian Hunnicutt<sup>53</sup> and Lisa June Kelley<sup>52</sup>, as shown in family tree 4.
10. JAMES MATHEW ASBURY (James's five-times-great-grandson) was born on 28 June 1991 in Lexington, Kentucky, USA to James Mickel Asbury<sup>54</sup> and Lisa June Kelley<sup>52</sup>, as shown in family tree 5.
11. LIAM JOSEPH ASBURY (James's five-times-great-grandson) was born to James Mickel Asbury<sup>54</sup> and Lisa June Kelley<sup>52</sup>, as shown in family tree 5.
12. KAYLA MEYER (James's five-times-great-granddaughter) was born to Mark Meyer<sup>60</sup> and Sherrie (Like a Daughter) Jones<sup>59</sup>, as shown in family tree 6.
13. CODY MEYER (James's five-times-great-grandson) was born to Mark Meyer<sup>60</sup> and Sherrie (Like a Daughter) Jones<sup>59</sup>, as shown in family tree 6.
14. TIM LETT (James's five-times-great-grandson) was born to Tim Lett<sup>63</sup> and Anita Carol Curtis<sup>62</sup>, as shown in family tree 7.
15. SARA LETT (James's five-times-great-granddaughter) was born to Tim Lett<sup>63</sup> and Anita Carol Curtis<sup>62</sup>, as shown in family tree 7.
16. CORY LETT (James's five-times-great-grandson) was born to Tim Lett<sup>63</sup> and Anita Carol Curtis<sup>62</sup>, as shown in family tree 7.
17. MERCEDES CURTIS (James's five-times-great-granddaughter) was born in August 1994 in Indianapolis, Marion, Indiana, USA to David Earl Curtis<sup>72</sup> and Toni Benner<sup>73</sup>, as shown in family tree 8.
18. SAVANNA JUNE CURTIS (James's five-times-great-granddaughter) was born on 14 June 1995 in Indianapolis, Marion, Indiana, USA to David Earl Curtis<sup>72</sup> and Toni Benner<sup>73</sup>, as shown in family tree 8.
19. IVIE SKI CURTIS (James's five-times-great-granddaughter) was born on 11 November 1996 to David Earl Curtis<sup>72</sup> and Toni Benner<sup>73</sup>, as shown in family tree 8.

**Generation of Four-Times-Great-Grandchildren**

20. BRENDA SUE SOBO (James's four-times-great-granddaughter) was born on 22 March 1958 in Klamath, Falls, Klamath, Organ, USA to Cornell Alexander Sobo, Jr.<sup>127</sup> and Charlotte Arlene Kennaday<sup>126</sup>, as shown in family tree 9.
21. JAMES VENCENT BOYD (James's four-times-great-granddaughter's husband) was born in 1956 in Cleveland, Ohio, USA.  
James Vencent Boyd married Brenda Sue Sobo<sup>20</sup>. They had two children:  
Caitlin Arlena Boyd<sup>1</sup> in 1992  
Jason Alexander Boyd<sup>2</sup> in 1994  
*This family is shown as family tree 1.*
22. RANDY EUGENE SOBO (James's four-times-great-grandson) was born on 7 July 1959 in Medford, Jackson, Organ, USA to Cornell Alexander Sobo, Jr.<sup>127</sup> and Charlotte Arlene Kennaday<sup>126</sup>, as shown in family tree 9.
23. KIM EILEEN JOHNSON (James's four-times-great-grandson's wife).  
Randy Eugene Sobo<sup>22</sup> married Kim Eileen Johnson. They had four children:  
Justin Kyle Sobo<sup>3</sup> in 1982  
Julie Erin Sobo<sup>4</sup> in 1985  
Travis Andrew Sobo<sup>5</sup> in 1987  
Tyler Jamison Sobo<sup>6</sup> in 1987  
*This family is shown as family tree 2.*
24. TERESA LYNN SOBO (James's four-times-great-granddaughter) was born on 19 August 1960 in Medford, Jackson, Organ, USA to Cornell Alexander Sobo, Jr.<sup>127</sup> and Charlotte Arlene Kennaday<sup>126</sup>, as shown in family tree 9.
25. TOM CLARIDGE (James's four-times-great-granddaughter's husband).  
Tom Claridge married Teresa Lynn Sobo<sup>24</sup>.
26. KARLA LYNN KENNADAY (James's four-times-great-granddaughter) was born on 8 July 1961 in Vallejo, Napa, California, USA to Thomas Eugene Kennaday<sup>128</sup> and Janice Benson<sup>129</sup>, as shown in family tree 10.
27. KATHY KAY KENNADAY (James's four-times-great-granddaughter) was born in 1962 in Vallejo, Napa, California, USA to Thomas Eugene Kennaday<sup>128</sup> and Janice Benson<sup>129</sup>, as shown in family tree 10.
28. LORI ANN GEPPERT (James's four-times-great-granddaughter) was born on 18 February 1960 in Portland, Washington, Organ, USA to August Henry Geppert<sup>131</sup> and Patty Ray Kennaday<sup>130</sup>, as shown in family tree 11.
29. DAVID LESTER WHITE (James's four-times-great-granddaughter's husband).  
David Lester White married Lori Ann Geppert<sup>28</sup>.
30. JUDY ARLENE GEPPERT (James's four-times-great-granddaughter) was born in 1962 in Portland, Washington, Organ, USA to August Henry Geppert<sup>131</sup> and Patty Ray Kennaday<sup>130</sup>, as shown in family tree 11.
31. DAIRLD GEAN WURTZ (James's four-times-great-granddaughter's husband).  
Dairld Gean Wurtz married Judy Arlene Geppert<sup>30</sup>.
32. TOMMY DUANE GEPPERT (James's four-times-great-grandson) was born in 1964 in Portland, Washington, Organ, USA to August Henry Geppert<sup>131</sup> and Patty Ray Kennaday<sup>130</sup>, as shown in family tree 11.
33. TODD KENNADAY (James's four-times-great-grandson) was born on 5 May 1960 in Oregon to Jack Wayne Kennaday<sup>136</sup> and Carol Lee Brant<sup>137</sup>, as shown in family tree 14.
34. JOYCE ELLEN JORGENSEN (James's four-times-great-grandson's wife) was born in 1962 in Phoenix, Orange, Arizona, USA.  
Todd Kennaday<sup>33</sup> married Joyce Ellen Jorgensen. They had two children:  
Adam Malaki Kennaday<sup>7</sup> in 1987  
Aaron Forest Kennaday<sup>8</sup> in 1990  
*This family is shown as family tree 3.*
35. DARREN KENNADAY (James's four-times-great-grandson) was born on 19 February 1964 to Jack Wayne Kennaday<sup>136</sup> and Carol Lee Brant<sup>137</sup>, as shown in family tree 14.
36. KELLY MICHELE KENNADAY (James's four-times-great-granddaughter) was born on 9 July 1965 to Gary Forrest Kennaday<sup>138</sup> and Alice Thompson<sup>140</sup>, as shown in family tree 15.
37. JEFFREY MICHAEL KENNADAY (James's four-times-great-grandson) was born on 26 September 1967 to Michael Joseph Kennaday<sup>141</sup> and Carolyn Williams<sup>142</sup>, as shown in family tree 16.

38. DELERA KAY LOTT (James's four-times-great-granddaughter) was born on 8 November 1958 to Jimmy Ray Lott<sup>143</sup> and Ellen Dollar Hyde<sup>144</sup>, as shown in family tree 17.
39. KATHY ANN LOTT (James's four-times-great-granddaughter) was born on 12 December 1960 to Jimmy Ray Lott<sup>143</sup> and Ellen Dollar Hyde<sup>144</sup>, as shown in family tree 17.
40. MANNETT MARIE LOTT (James's four-times-great-granddaughter) was born on 4 June 1964 to Jimmy Ray Lott<sup>143</sup> and Ellen Dollar Hyde<sup>144</sup>, as shown in family tree 17.
41. ROXY ANN LOTT (James's four-times-great-granddaughter) was born on 24 January 1966 to Jimmy Ray Lott<sup>143</sup> and Ellen Dollar Hyde<sup>144</sup>, as shown in family tree 17.
42. LEE ANN MARIE LOTT (James's four-times-great-granddaughter) was born in August 1960 to Al Blunt<sup>146</sup> and Rosa Lee Lott<sup>145</sup>, as shown in family tree 18.
43. CALVIN E TERETT LOTT (James's four-times-great-grandson) was born in July 1962 to Al Blunt<sup>146</sup> and Rosa Lee Lott<sup>145</sup>, as shown in family tree 18.
44. KATY SUE BLUNT (James's four-times-great-granddaughter) was born on 21 June 1965 to Al Blunt<sup>146</sup> and Rosa Lee Lott<sup>145</sup>, as shown in family tree 18.
45. ED BLUNT (James's four-times-great-grandson) was born to Al Blunt<sup>146</sup> and Rosa Lee Lott<sup>145</sup>, as shown in family tree 18.
46. JOHN FRANK LOTT (James's four-times-great-grandson) was born on 23 September 1960 to Calvin Jay Lott<sup>147</sup> and Jo Ann Sturgess<sup>148</sup>, as shown in family tree 19.
47. DIANA LOTT (James's four-times-great-granddaughter) was born on 13 September 1963 to Calvin Jay Lott<sup>147</sup> and Jo Ann Sturgess<sup>148</sup>, as shown in family tree 19.
48. MICHELE LOTT (James's four-times-great-granddaughter) was born in June 1967 to Calvin Jay Lott<sup>147</sup> and Jo Ann Sturgess<sup>148</sup>, as shown in family tree 19.
49. LISA SLOANE (James's four-times-great-granddaughter) was born to Mr. Sloane<sup>150</sup> and Mable Bea Lott<sup>149</sup>, as shown in family tree 20.
50. LARRY SLOANE (James's four-times-great-grandson) was born to Mr. Sloane<sup>150</sup> and Mable Bea Lott<sup>149</sup>, as shown in family tree 20.
51. MICHAEL RAMSEY (ADOPTED) (James's four-times-great-grandson) was born to Earl Efton (Butch) Ramsey<sup>132</sup> and Rosa L Hubbard<sup>133</sup>, as shown in family tree 12.
52. LISA JUNE KELLEY (James's four-times-great-granddaughter) was born on 18 December 1963 in Carlisle, Kentucky, USA to Ronald David Kelley, Sr.<sup>154</sup> and Betty Carol Fitzpatrick<sup>155</sup>, as shown in family tree 21. (Lisa married twice. She was married to Cristian Hunnicutt<sup>53</sup> and James Mickel Asbury<sup>54</sup>.)
53. CRISTIAN HUNNICUTT (James's four-times-great-granddaughter's husband) was born in Tennessee. Cristian Hunnicutt married Lisa June Kelley<sup>52</sup>, aged 18, on 13 February 1982 in Indianapolis, Indiana, USA. They had one son:  
     Christian David Hunnicutt<sup>9</sup> in 1983  
*This family is shown as family tree 4.*
54. JAMES MICKEL ASBURY (James's four-times-great-granddaughter's husband) was born in Cynthiana, Kentucky, USA. James Mickel Asbury married Lisa June Kelley<sup>52</sup>, aged 26, on 26 May 1990 in Cynthiana, Scott, Kentucky, USA. They had two children:  
     James Mathew Asbury<sup>10</sup> in 1991  
     Liam Joseph Asbury<sup>11</sup>  
*This family is shown as family tree 5.*
55. MELINDA (ADOPTED) RAMSEY (James's four-times-great-granddaughter) was born to Earl Efton (Butch) Ramsey<sup>132</sup> and Rosa L Hubbard<sup>133</sup>, as shown in family tree 12.
56. ANNA CAROL KELLEY (James's four-times-great-granddaughter) was born on 27 November 1964 to Ronald David Kelley, Sr.<sup>154</sup> and Betty Carol Fitzpatrick<sup>155</sup>, as shown in family tree 21.
57. GREGORY WERT (James's four-times-great-granddaughter's husband).

Gregory Wert married Anna Carol Kelley<sup>56</sup>, aged 18, on 28 May 1983 in Indianapolis, Indiana, USA.

58. RONALD DAVID KELLEY, JR. (James's four-times-great-grandson) was born on 9 June 1966 in Lexington, Kentucky, USA to Ronald David Kelley, Sr.<sup>154</sup> and Betty Carol Fitzpatrick<sup>155</sup>, as shown in family tree 21. Ronald died on 15 September 1997, aged 31, in Indianapolis, Marion, Indiana, USA. He was buried in Washinton Park Cemetery, Indianapolis, Indiana.
59. SHERRIE (LIKE A DAUGHTER) JONES (James's four-times-great-granddaughter) was born to Ronald David Kelley, Sr.<sup>154</sup> and Betty Carol Fitzpatrick<sup>155</sup>, as shown in family tree 21.
60. MARK MEYER (James's four-times-great-granddaughter's husband).  
Mark Meyer married Sherrie (Like a Daughter) Jones<sup>59</sup> in November 1987. They had two children:  
Kayla Meyer<sup>12</sup>  
Cody Meyer<sup>13</sup>  
*This family is shown as family tree 6.*
61. BOB HAYES (James's four-times-great-grandson) was born to Bob Hayes<sup>135</sup> and Afton Ernstine (Marier) Ramsey<sup>134</sup>, as shown in family tree 13.
62. ANITA CAROL CURTIS (James's four-times-great-granddaughter) was born on 9 April 1964 in ICarlisle, Nichlos, Kentucky, USA to Norman Perry Curtis<sup>157</sup> and Carolyn June Kelley<sup>156</sup>, as shown in family tree 22. (Anita married three times. She was married to Tim Lett<sup>63</sup>, George Stamps<sup>64</sup> and Mike Phelps<sup>65</sup>.)
63. TIM LETT (James's four-times-great-granddaughter's husband).  
Tim Lett married Anita Carol Curtis<sup>62</sup>. They had three children:  
Tim Lett<sup>14</sup>  
Sara Lett<sup>15</sup>  
Cory Lett<sup>16</sup>  
*This family is shown as family tree 7.*
64. GEORGE STAMPS (James's four-times-great-granddaughter's husband).  
George Stamps married Anita Carol Curtis<sup>62</sup>.
65. MIKE PHELPS (James's four-times-great-granddaughter's husband).  
Mike Phelps married Anita Carol Curtis<sup>62</sup>, aged 20, on 27 August 1984.
66. LINDA HAYES (James's four-times-great-granddaughter) was born in 1957 to Bob Hayes<sup>135</sup> and Afton Ernstine (Marier) Ramsey<sup>134</sup>, as shown in family tree 13.
67. NORMAN PERRY CURTIS, JR. (James's four-times-great-grandson) was born on 28 August 1966 in Indianapolis, Marion, Indiana, USA to Norman Perry Curtis<sup>157</sup> and Carolyn June Kelley<sup>156</sup>, as shown in family tree 22.
68. BARBARA UNKNOWN (James's four-times-great-grandson's wife).  
Norman Perry Curtis, Jr.<sup>67</sup> married Barbara Unknown.
69. MELONY JO CURTIS (James's four-times-great-granddaughter) was born on 14 January 1970 in Indianapolis, Marion, Indiana, USA to Norman Perry Curtis<sup>157</sup> and Carolyn June Kelley<sup>156</sup>, as shown in family tree 22. Melony died on 8 December 1970 as an infant, in Indianapolis, Marion, Indiana, USA. She was buried in Carlisle, Cemetery, Carlisle, Kentucky.
70. TOBY HAYES (James's four-times-great-grandson) was born in 1958 to Bob Hayes<sup>135</sup> and Afton Ernstine (Marier) Ramsey<sup>134</sup>, as shown in family tree 13.
71. KAREN HAYES (James's four-times-great-granddaughter) was born in 1962 to Bob Hayes<sup>135</sup> and Afton Ernstine (Marier) Ramsey<sup>134</sup>, as shown in family tree 13.
72. DAVID EARL CURTIS (James's four-times-great-grandson) was born on 17 April 1973 in Indianapolis, Marion, Indiana, USA to Norman Perry Curtis<sup>157</sup> and Carolyn June Kelley<sup>156</sup>, as shown in family tree 22.
73. TONI BENNER (James's four-times-great-grandson's wife).  
David Earl Curtis<sup>72</sup>, aged 23, married Toni Benner on 7 July 1996. They had three children:  
Mercedes Curtis<sup>17</sup> in 1994  
Savanna June Curtis<sup>18</sup> in 1995  
Ivie Ski Curtis<sup>19</sup> in 1996  
*This family is shown as family tree 8.*
74. NICHOLAS ISAIAH KENNADAY (James's four-times-great-grandson) was born in 1978 in Roseburg, Douglas, Oregon, USA to David Debernardi Kennaday<sup>167</sup> and Paula Jo Smith<sup>168</sup>, as shown in family tree 25.

75. ELIZABETH ALTA OLIVIA KENNADAY (James's four-times-great-granddaughter) was born in 1980 in Roseburg, Douglas, Oregon, USA to David Debernardi Kennaday<sup>167</sup> and Paula Jo Smith<sup>168</sup>, as shown in family tree 25.
76. CRISTINA DIANNE KENNADAY (James's four-times-great-granddaughter) was born in 1982 in Roseburg, Douglas, Oregon, USA to David Debernardi Kennaday<sup>167</sup> and Paula Jo Smith<sup>168</sup>, as shown in family tree 25.
77. JOSHUA JOLIN KENNADAY (James's four-times-great-grandson) was born in 1982 in Glide, Douglas, Oregon, USA to Steven Scott Kennaday<sup>169</sup> and Catherine Susan Lavelle<sup>170</sup>, as shown in family tree 26.
78. MALLORY KENNADAY (James's four-times-great-granddaughter) was born to Steven Scott Kennaday<sup>169</sup> and Danielle Reed<sup>171</sup>, as shown in family tree 27.
79. REED KENNADAY (James's four-times-great-grandson) was born to Steven Scott Kennaday<sup>169</sup> and Danielle Reed<sup>171</sup>, as shown in family tree 27.
80. PATRICIA LEIGH KENNADAY (James's four-times-great-granddaughter) was born in 1979 in San Diego, San Diego, California, USA to Fredrick Frank Kennaday<sup>172</sup> and Brigid Ann Young<sup>173</sup>, as shown in family tree 28.
81. ANTHONY JOSEPH KENNADAY (James's four-times-great-grandson) was born in 1981 in Roseburg, Douglas, Oregon, USA to Fredrick Frank Kennaday<sup>172</sup> and Brigid Ann Young<sup>173</sup>, as shown in family tree 28.
82. GORDON SCOTT (SCOTTY) JOHNSON (James's four-times-great-grandson) was born on 10 August 1962 to Gordon Johnson<sup>162</sup> and Sherry Jean Marier<sup>160</sup>, as shown in family tree 23.
83. STANLEY (STAN) JOHNSON (James's four-times-great-grandson) was born on 14 June 1965 to Gordon Johnson<sup>162</sup> and Sherry Jean Marier<sup>160</sup>, as shown in family tree 23.
84. MIKE ALLEN FORRESTER, JR. (James's four-times-great-grandson) was born on 22 January 1966 to Micheal A Forrester<sup>164</sup> and Jane Marie Marier<sup>163</sup>, as shown in family tree 24.
85. TOMMY JAMES FORRESTER (James's four-times-great-grandson) was born on 4 May 1968 to Micheal A Forrester<sup>164</sup> and Jane Marie Marier<sup>163</sup>, as shown in family tree 24.
86. JAMIE FORRESTER (James's four-times-great-granddaughter) was born to Micheal A Forrester<sup>164</sup> and Jane Marie Marier<sup>163</sup>, as shown in family tree 24.
87. ROBBYN CHERTER WHITMAN (James's four-times-great-grandson) was born in 1959 to Nelson Chester Whitman<sup>174</sup> and Cecelia Kay Pendergrass<sup>175</sup>, as shown in family tree 29.
88. PERI ANN WHITMAN (James's four-times-great-granddaughter) was born in 1960 to Nelson Chester Whitman<sup>174</sup> and Cecelia Kay Pendergrass<sup>175</sup>, as shown in family tree 29.
89. MARCUS PINE WHITMAN (James's four-times-great-grandson) was born in 1962 to Nelson Chester Whitman<sup>174</sup> and Claudette Irene Corlett<sup>176</sup>, as shown in family tree 30.
90. MICHEAL GERALD STURM WHITMAN (James's four-times-great-grandson) was born in 1968 to Boyd David Whitman<sup>178</sup> and Carolyn M Thompson<sup>179</sup>, as shown in family tree 31.
91. PATRICK KEITH WHITMAN (James's four-times-great-grandson) was born in 1969 to Boyd David Whitman<sup>178</sup> and Carolyn M Thompson<sup>179</sup>, as shown in family tree 31.
92. NATHANIELLE REBECCA WHITMAN (James's four-times-great-granddaughter) was born in 1973 to Boyd David Whitman<sup>178</sup> and Carolyn M Thompson<sup>179</sup>, as shown in family tree 31.
93. GRANT DOUGLAS WHITMAN (James's four-times-great-grandson) was born in 1967 to Richard Ward Whitman<sup>180</sup> and Robin Knipp Jouett<sup>181</sup>, as shown in family tree 32.
94. GAIL ROBIN WHITMAN (James's four-times-great-granddaughter) was born in 1968 to Richard Ward Whitman<sup>180</sup> and Robin Knipp Jouett<sup>181</sup>, as shown in family tree 32.
95. TORI DAWN BARTLETT (James's four-times-great-granddaughter) was born in 1963 to Joseph Grant Bartlett<sup>183</sup> and Charlotte Louise Whitman<sup>182</sup>, as shown in family tree 33.



96. TRAVIS DARRYL BARTLETT (James's four-times-great-grandson) was born in 1969 to Joseph Grant Bartlett<sup>183</sup> and Charlotte Louise Whitman<sup>182</sup>, as shown in family tree 33.
97. TREVOR DAVID BARTLETT (James's four-times-great-grandson) was born in 1974 to Joseph Grant Bartlett<sup>183</sup> and Charlotte Louise Whitman<sup>182</sup>, as shown in family tree 33.
98. BRADLY TOMMY THOMPSON (James's four-times-great-grandson) was born in 1966 to Tommy M Thompson<sup>185</sup> and Marcella Ann Whitman<sup>184</sup>, as shown in family tree 34.
99. FRED WINTON SMITH (James's four-times-great-grandson) was born in 1967 to Fred Winton Smith<sup>187</sup> and Phillis Lana Whitman<sup>186</sup>, as shown in family tree 35.
100. COLLIN WADE WHITMAN (James's four-times-great-grandson) was born in 1969 to Fred Winton Smith<sup>187</sup> and Phillis Lana Whitman<sup>186</sup>, as shown in family tree 35.
101. STUART BRANSON SELF (James's four-times-great-grandson) was born in 1974 to Stanley Howard Self<sup>189</sup> and Laurel Alice Whitman<sup>188</sup>, as shown in family tree 36.
102. IAN MATHEW SELF (James's four-times-great-grandson) was born in 1975 to Stanley Howard Self<sup>189</sup> and Laurel Alice Whitman<sup>188</sup>, as shown in family tree 36.
103. ASHLEY CHESTER SELF (James's four-times-great-grandson) was born in 1977 to Stanley Howard Self<sup>189</sup> and Laurel Alice Whitman<sup>188</sup>, as shown in family tree 36.
104. THOMAS ELLIOTT PAGE (James's four-times-great-grandson) was born in 1971 in Ogden, Weber, Utah, USA to Ronald Otis Page<sup>227</sup> and Linda Ann Cairns<sup>226</sup>, as shown in family tree 37.
105. JOHNATHAN JACK PAGE (James's four-times-great-grandson) was born in 1973 in Rawlins, Carbon, Wyoming, USA to Ronald Otis Page<sup>227</sup> and Linda Ann Cairns<sup>226</sup>, as shown in family tree 37.
106. DONALD GRANT PAGE (James's four-times-great-grandson) was born in 1975 in Rawlins, Carbon, Wyoming, USA to Ronald Otis Page<sup>227</sup> and Linda Ann Cairns<sup>226</sup>, as shown in family tree 37.
107. TRIANA MARIE CAMPBELL (James's four-times-great-granddaughter) was born in 1978 in Salt Lake City, Salt Lake, Utah, USA to Craig Campbell<sup>229</sup> and Christine Marie Cairns<sup>228</sup>, as shown in family tree 38.
108. HOLLY ANN CAMPBELL (James's four-times-great-granddaughter) was born in 1980 in Salt Lake City, Salt Lake, Utah, USA to Craig Campbell<sup>229</sup> and Christine Marie Cairns<sup>228</sup>, as shown in family tree 38.
109. ERIC RAYMOND CAMPBELL (James's four-times-great-grandson) was born in 1985 in Salt Lake City, Salt Lake, Utah, USA to Craig Campbell<sup>229</sup> and Christine Marie Cairns<sup>228</sup>, as shown in family tree 38.
110. RACHEL ELIZABETH CAIRNS (James's four-times-great-granddaughter) was born in 1979 to Jack Lavoy Cairns, Jr.<sup>230</sup> and Rebecca Cassler<sup>231</sup>, as shown in family tree 39.
111. MARY MELISSA CAIRNS (James's four-times-great-granddaughter) was born in 1983 to Jack Lavoy Cairns, Jr.<sup>230</sup> and Rebecca Cassler<sup>231</sup>, as shown in family tree 39.
112. JEREMY ALAN HANSEN (James's four-times-great-grandson) was born in 1975 in Craig, Moffat, Colorado, USA to Alan Hansen<sup>233</sup> and Elizabeth Kay Cairns<sup>232</sup>, as shown in family tree 40.
113. AARON WAYNE HANSEN (James's four-times-great-grandson) was born in 1976 in Idaho Falls, Bonneville, Idaho, USA to Alan Hansen<sup>233</sup> and Elizabeth Kay Cairns<sup>232</sup>, as shown in family tree 40.
114. MICHAEL BRENT HANSEN (James's four-times-great-grandson) was born in 1979 in Idaho Falls, Bonneville, Idaho, USA to Alan Hansen<sup>233</sup> and Elizabeth Kay Cairns<sup>232</sup>, as shown in family tree 40.
115. AMY NICOLE HANSEN (James's four-times-great-granddaughter) was born in 1981 in Idaho Falls, Bonneville, Idaho, USA to Alan Hansen<sup>233</sup> and Elizabeth Kay Cairns<sup>232</sup>, as shown in family tree 40.
116. JACOB KARL HANSEN (James's four-times-great-grandson) was born in 1983 in Idaho Falls, Bonneville, Idaho, USA to Alan Hansen<sup>233</sup> and Elizabeth Kay Cairns<sup>232</sup>, as shown in family tree 40.

117. DORCI KAE CAIRNS (James's four-times-great-granddaughter) was born in 1983 in Idaho Falls, Bonneville, Idaho, USA to William Wayne Cairns<sup>234</sup> and Kae Porter<sup>235</sup>, as shown in family tree 41.
118. JACE WILLIAM CAIRNS (James's four-times-great-grandson) was born in 1988 in Idaho Falls, Bonneville, Idaho, USA to William Wayne Cairns<sup>234</sup> and Kae Porter<sup>235</sup>, as shown in family tree 41.
119. BRINDI MICHELLE CAIRNS (James's four-times-great-granddaughter) was born in 1991 in Idaho Falls, Bonneville, Idaho, USA to William Wayne Cairns<sup>234</sup> and Kae Porter<sup>235</sup>, as shown in family tree 41.
120. TIFFANY ANNE COOPER (James's four-times-great-granddaughter) was born in 1977 in Logan, Cache, Utah, USA to John Ellery Cooper<sup>237</sup> and Rebecca Gay Cairns<sup>236</sup>, as shown in family tree 42.
121. STEVE HIX (James's four-times-great-granddaughter's husband) was born in 1977.  
Steve Hix married Tiffany Anne Cooper<sup>120</sup>.
122. HILLARY RANEE COOPER (James's four-times-great-granddaughter) was born in 1978 in Logan, Cache, Utah, USA to John Ellery Cooper<sup>237</sup> and Rebecca Gay Cairns<sup>236</sup>, as shown in family tree 42.
123. KREETA ANN JEBENS (James's four-times-great-granddaughter) was born in 1975 in Rawlins, Carbon, Wyoming, USA to Carlie Jebens<sup>241</sup> and Phyllis Ann Wilson<sup>240</sup>, as shown in family tree 43.
124. KOREY KAY JEBENS (James's four-times-great-granddaughter) was born in 1977 in Rawlins, Carbon, Wyoming, USA to Carlie Jebens<sup>241</sup> and Phyllis Ann Wilson<sup>240</sup>, as shown in family tree 43.
125. CARLIE NORMAN JEBENS (James's four-times-great-grandson) was born in 1979 in Rawlins, Carbon, Wyoming, USA to Carlie Jebens<sup>241</sup> and Phyllis Ann Wilson<sup>240</sup>, as shown in family tree 43. Carlie died in 1995, aged about 16.

#### Generation of Great-Great-Great-Grandchildren

126. CHARLOTTE ARLENE KENNADAY (James's great-great-great-granddaughter) was born on 28 October 1933 to Thomas Earl Kennaday<sup>252</sup> and Gladys Eleanor Ream<sup>253</sup>, as shown in family tree 44.
127. CORNELL ALEXANDER SOBO, JR. (James's great-great-great-granddaughter's husband) was born on 28 October 1933. Cornell Alexander Sobo, Jr. married Charlotte Arlene Kennaday<sup>126</sup>. They had three children:  
Brenda Sue Sobo<sup>20</sup> in 1958  
Randy Eugene Sobo<sup>22</sup> in 1959  
Teresa Lynn Sobo<sup>24</sup> in 1960  
*This family is shown as family tree 9.*
128. THOMAS EUGENE KENNADAY (James's great-great-great-grandson) was born on 14 August 1935 in Saratoga, Carbon, Wyoming, USA to Thomas Earl Kennaday<sup>252</sup> and Gladys Eleanor Ream<sup>253</sup>, as shown in family tree 44.
129. JANICE BENSON (James's great-great-great-grandson's wife).  
Thomas Eugene Kennaday<sup>128</sup>, aged about 24, married Janice Benson in 1960 in Antonio, Texas. They had two children:  
Karla Lynn Kennaday<sup>26</sup> in 1961  
Kathy Kay Kennaday<sup>27</sup> in 1962  
*This family is shown as family tree 10.*
130. PATTY RAY KENNADAY (James's great-great-great-granddaughter) was born on 3 August 1937 in Rawlins, Carbon, Wyoming, USA to Thomas Earl Kennaday<sup>252</sup> and Gladys Eleanor Ream<sup>253</sup>, as shown in family tree 44.
131. AUGUST HENRY GEPPERT (James's great-great-great-granddaughter's husband) was born in 1937 in Portland, Washington, Oregon, USA.  
August Henry Geppert, aged about 21, married Patty Ray Kennaday<sup>130</sup>, aged 20, on 26 July 1958. They had three children:  
Lori Ann Geppert<sup>28</sup> in 1960  
Judy Arlene Geppert<sup>30</sup> in 1962  
Tommy Duane Geppert<sup>32</sup> in 1964  
*This family is shown as family tree 11.*
132. EARL EFTON (BUTCH) RAMSEY (James's great-great-great-grandson) was born on 24 April 1937 to Earl N Ramsey<sup>256</sup> and Florence Mae Kennaday<sup>254</sup>, as shown in family tree 45.
133. ROSA L HUBBARD (James's great-great-great-grandson's wife) was born on 26 September 1937.  
Earl Efton (Butch) Ramsey<sup>132</sup> married Rosa L Hubbard. They had two children:

Michale Ramsey (adopted)<sup>51</sup>  
 Melinda (adopted) Ramsey<sup>55</sup>  
*This family is shown as family tree 12.*

134. AFTON ERNSTINE (MARIER) RAMSEY (James's great-great-great-granddaughter) was born to Earl N Ramsey<sup>256</sup> and Florence Mae Kennaday<sup>254</sup>, as shown in family tree 45.

135. BOB HAYES (James's great-great-great-granddaughter's husband).  
 Bob Hayes married Afton Ernstine (Marier) Ramsey<sup>134</sup>. They had four children:  
 Bob Hayes<sup>61</sup>  
 Linda Hayes<sup>66</sup> in 1957  
 Toby Hayes<sup>70</sup> in 1958  
 Karen Hayes<sup>71</sup> in 1962

*This family is shown as family tree 13.*

136. JACK WAYNE KENNADAY (James's great-great-great-grandson) was born on 15 December 1939 to Ellen (Dude) Stockwell<sup>258</sup> and Forest Jack Kennaday<sup>257</sup>, as shown in family tree 46.

137. CAROL LEE BRANT (James's great-great-great-grandson's wife).  
 Jack Wayne Kennaday<sup>136</sup> married Carol Lee Brant. They had two children:  
 Todd Kennaday<sup>33</sup> in 1960  
 Darren Kennaday<sup>35</sup> in 1964

*This family is shown as family tree 14.*

138. GARY FORREST KENNADAY (James's great-great-great-grandson) was born on 7 February 1942 to Ellen (Dude) Stockwell<sup>258</sup> and Forest Jack Kennaday<sup>257</sup>, as shown in family tree 46.

(Gary married twice. He was married to Vicki Compton<sup>139</sup> and Alice Thompson<sup>140</sup>.)

139. VICKI COMPTON (James's great-great-great-grandson's wife).

Gary Forrest Kennaday<sup>138</sup> married Vicki Compton.

140. ALICE THOMPSON (James's great-great-great-grandson's wife).

Gary Forrest Kennaday<sup>138</sup> married Alice Thompson. They had one daughter:  
 Kelly Michele Kennaday<sup>36</sup> in 1965

*This family is shown as family tree 15.*

141. MICHAEL JOSEPH KENNADAY (James's great-great-great-grandson) was born to Ellen (Dude) Stockwell<sup>258</sup> and Forest Jack Kennaday<sup>257</sup>, as shown in family tree 46.

142. CAROLYN WILLIAMS (James's great-great-great-grandson's wife).

Michael Joseph Kennaday<sup>141</sup> married Carolyn Williams. They had one son:  
 Jeffrey Michael Kennaday<sup>37</sup> in 1967

*This family is shown as family tree 16.*

143. JIMMY RAY LOTT (James's great-great-great-grandson) was born on 22 March 1940 to Calvin Lott<sup>260</sup> and Rose Marie Kennaday<sup>259</sup>, as shown in family tree 47.

144. ELLEN DOLLAR HYDE (James's great-great-great-grandson's wife).

Jimmy Ray Lott<sup>143</sup> married Ellen Dollar Hyde. They had four children:  
 Delera Kay Lott<sup>38</sup> in 1958  
 Kathy Ann Lott<sup>39</sup> in 1960  
 MAnnett Marie Lott<sup>40</sup> in 1964  
 Roxy Ann Lott<sup>41</sup> in 1966

*This family is shown as family tree 17.*

145. ROSA LEE LOTT (James's great-great-great-granddaughter) was born to Calvin Lott<sup>260</sup> and Rose Marie Kennaday<sup>259</sup>, as shown in family tree 47.

146. AL BLUNT (James's great-great-great-granddaughter's husband).

Al Blunt married Rosa Lee Lott<sup>145</sup>. They had four children:  
 Lee Ann Marie Lott<sup>42</sup> in 1960  
 Calvin E Terett Lott<sup>43</sup> in 1962  
 Katy Sue Blunt<sup>44</sup> in 1965  
 Ed Blunt<sup>45</sup>

*This family is shown as family tree 18.*

147. CALVIN JAY LOTT (James's great-great-great-grandson) was born to Calvin Lott<sup>260</sup> and Rose Marie Kennaday<sup>259</sup>, as shown in family tree 47.

148. JO ANN STURGESS (James's great-great-great-grandson's wife).

Calvin Jay Lott<sup>147</sup> married Jo Ann Sturgess. They had three children:

John Frank Lott<sup>46</sup> in 1960

Diana Lott<sup>47</sup> in 1963

Michele Lott<sup>48</sup> in 1967

*This family is shown as family tree 19.*

149. MABLE BEA LOTT (James's great-great-great-granddaughter) was born to Calvin Lott<sup>260</sup> and Rose Marie Kennaday<sup>259</sup>, as shown in family tree 47.

(Mable married twice. She was married to Mr. Sloane<sup>150</sup> and Lawrence P Patchins<sup>151</sup>.)

150. MR. SLOANE (James's great-great-great-granddaughter's husband).

Mr. Sloane married Mable Bea Lott<sup>149</sup>. They had two children:

Lisa Sloane<sup>49</sup>

Larry Sloane<sup>50</sup>

*This family is shown as family tree 20.*

151. LAWRENCE P PATCHINS (James's great-great-great-granddaughter's husband).

Lawrence P Patchins married Mable Bea Lott<sup>149</sup>.

152. JOHN LOTT (James's great-great-great-grandson) was born to Calvin Lott<sup>260</sup> and Rose Marie Kennaday<sup>259</sup>, as shown in family tree 47.

153. RANDY EUGENE LOTT (James's great-great-great-grandson) was born on 29 December 1962 to Calvin Lott<sup>260</sup> and Rose Marie Kennaday<sup>259</sup>, as shown in family tree 47.

154. RONALD DAVID KELLEY, SR. (James's great-great-great-grandson) was born on 10 September 1943 in Pueblo, Colorado, USA to John David Kelley<sup>262</sup> and Iva June Kennaday<sup>261</sup>, as shown in family tree 48.

*Note: Ron and Betty lived in a trailer on Myers Station Road in Carlisle, Kentucky after they were married. In November of 1963 they moved into a house in Myers Station living there a short time before moving to a house in Carlisle in 1964. In September of 1964 we moved to George town to be closer to where Ron took a Job at Stiohn Products. After working there about Ron enroled into a Government Sponsored program as a Tool and Die maker. Where He finished his apprenticeship in 1969. Ron and Betty had their house to burn in the summer of 1969 while visiting Betty's sister Sandy Thompson in Tampa Florida.*

*Ron & Betty Took in foster kid during the 80's.*

*One of the foster kids, Steven Wayn Banks 12-22-1980 - 8-10-1981 another was Sherie Jones in 2-1982.*

155. BETTY CAROL FITZPATRICK (James's great-great-great-grandson's wife) was born on 14 April 1947 in Paris, Bourbon, Kentucky, USA to Edward S (Pete) Fitzpatrick<sup>372</sup> and Virginia Ruth Gulett<sup>374</sup>.

*[See also: Indirectly related via Betty Carol Fitzpatrick]*

Ronald David Kelley, Sr.<sup>154</sup>, aged 19, married Betty Carol Fitzpatrick, aged 15, on 6 April 1963 in Carlisle, Kentucky, USA. They had four children:

Lisa June Kelley<sup>52</sup> in 1963

Anna Carol Kelley<sup>56</sup> in 1964

Ronald David Kelley, Jr.<sup>58</sup> in 1966

Sherrie (Like a Daughter) Jones<sup>59</sup>

*This family is shown as family tree 21.*

156. CAROLYN JUNE KELLEY (James's great-great-great-granddaughter) was born on 8 February 1945 in Carlisle, Kentucky, USA to John David Kelley<sup>262</sup> and Iva June Kennaday<sup>261</sup>, as shown in family tree 48. Carolyn died on 25 July 1993, aged 48. She was buried in Creamation: Ashes on grave of Melony Jo Curtis Daughter.

157. NORMAN PERRY CURTIS (James's great-great-great-granddaughter's husband) was born in 1940.

Norman Perry Curtis, aged about 22, married Carolyn June Kelley<sup>156</sup>, aged 17, on 12 January 1963 in Carlisle, Kentucky, USA. They had four children:

Anita Carol Curtis<sup>62</sup> in 1964

Norman Perry Curtis, Jr.<sup>67</sup> in 1966

Melony Jo Curtis<sup>69</sup> in 1970

David Earl Curtis<sup>72</sup> in 1973

*This family is shown as family tree 22.*

158. STANLEY JOHNSON (James's great-great-great-grandson) was born to Gordon Johnson<sup>264</sup> and Bonnie Jean Kennaday<sup>263</sup>, as shown in family tree 49.

159. SCOTT JOHNSON (James's great-great-great-grandson) was born to Gordon Johnson<sup>264</sup> and Bonnie Jean Kennaday<sup>263</sup>, as shown in family tree 49.

160. SHERRY JEAN MARIER (James's great-great-great-granddaughter) was born on 22 November 1942 to James Martin Marier<sup>265</sup> and Bonnie Jean Kennaday<sup>263</sup>, as shown in family tree 50.  
(Sherry married twice. She was married to Jim Schoenwald<sup>161</sup> and Gordon Johnson<sup>162</sup>.)
161. JIM SCHOENWALD (James's great-great-great-granddaughter's husband).  
Jim Schoenwald married Sherry Jean Marier<sup>160</sup>.
162. GORDON JOHNSON (James's great-great-great-granddaughter's husband).  
Gordon Johnson married Sherry Jean Marier<sup>160</sup>. They had two children:  
Gordon Scott (Scotty) Johnson<sup>82</sup> in 1962  
Stanley (Stan) Johnson<sup>83</sup> in 1965  
*This family is shown as family tree 23.*
163. JANE MARIE MARIER (James's great-great-great-granddaughter) was born on 4 February 1945 to James Martin Marier<sup>265</sup> and Bonnie Jean Kennaday<sup>263</sup>, as shown in family tree 50.
164. MICHEAL A FORRESTER (James's great-great-great-granddaughter's husband).  
Micheal A Forrester married Jane Marie Marier<sup>163</sup>. They had three children:  
Mike Allen Forrester, Jr.<sup>84</sup> in 1966  
Tommy James Forrester<sup>85</sup> in 1968  
Jamie Forrester<sup>86</sup>  
*This family is shown as family tree 24.*
165. GARY JO KENNADAY (James's great-great-great-grandson) was born on 4 March 1946 in Roseburg, Douglas, Oregon, USA to Lincoln Frank Kennaday<sup>266</sup> and Joan Olivia Debernardi<sup>267</sup>, as shown in family tree 51.
166. RITA DIANNE RHOADS (James's great-great-great-grandson's wife) was born in 1951.  
Gary Jo Kennaday<sup>165</sup> married Rita Dianne Rhoads.
167. DAVID DEBERNARDI KENNADAY (James's great-great-great-grandson) was born on 8 January 1949 in Roseburg, Douglas, Oregon, USA to Lincoln Frank Kennaday<sup>266</sup> and Joan Olivia Debernardi<sup>267</sup>, as shown in family tree 51.
168. PAULA JO SMITH (James's great-great-great-grandson's wife) was born in 1953 in Roseburg, Douglas, Oregon, USA.  
David Debernardi Kennaday<sup>167</sup> married Paula Jo Smith. They had three children:  
Nicholas Isaiah Kennaday<sup>74</sup> in 1978  
Elizabeth Alta Olivia Kennaday<sup>75</sup> in 1980  
Cristina Dianne Kennaday<sup>76</sup> in 1982  
*This family is shown as family tree 25.*
169. STEVEN SCOTT KENNADAY (James's great-great-great-grandson) was born on 5 March 1956 in Roseburg, Douglas, Oregon, USA to Lincoln Frank Kennaday<sup>266</sup> and Joan Olivia Debernardi<sup>267</sup>, as shown in family tree 51.  
(Steven married twice. He was married to Catherine Susan Lavelle<sup>170</sup> and Danielle Reed<sup>171</sup>.)
170. CATHERINE SUSAN LAVELLE (James's great-great-great-grandson's wife) was born in 1956 in Van Nuys, California, USA.  
Steven Scott Kennaday<sup>169</sup> married Catherine Susan Lavelle. They had one son:  
Joshua Jolin Kennaday<sup>77</sup> in 1982  
*This family is shown as family tree 26.*
171. DANIELLE REED (James's great-great-great-grandson's wife).  
Steven Scott Kennaday<sup>169</sup> married Danielle Reed. They had two children:  
Mallory Kennaday<sup>78</sup>  
Reed Kennaday<sup>79</sup>  
*This family is shown as family tree 27.*
172. FREDRICK FRANK KENNADAY (James's great-great-great-grandson) was born on 5 May 1957 in Roseburg, Douglas, Oregon, USA to Lincoln Frank Kennaday<sup>266</sup> and Joan Olivia Debernardi<sup>267</sup>, as shown in family tree 51.
173. BRIGID ANN YOUNG (James's great-great-great-grandson's wife) was born in 1956 in Burbank, Los Angeles, California, USA.  
Fredrick Frank Kennaday<sup>172</sup> married Brigid Ann Young. They had two children:  
Patricia Leigh Kennaday<sup>80</sup> in 1979  
Anthony Joseph Kennaday<sup>81</sup> in 1981  
*This family is shown as family tree 28.*
174. NELSON CHESTER WHITMAN (James's great-great-great-grandson) was born in 1939 in BigPiney, Sublette, Wyoming, USA to Bruce Douglas Whitman<sup>276</sup> and Frances Amonda Davidson<sup>275</sup>, as shown in family tree 52.  
(Nelson married three times. He was married to Cecelia Kay Pendergrass<sup>175</sup>, Claudette Irene Corlett<sup>176</sup> and Lorraine Madden<sup>177</sup>.)
175. CECELIA KAY PENDERGRASS (James's great-great-great-grandson's wife).

- Nelson Chester Whitman<sup>174</sup> married Cecelia Kay Pendergrass. They had two children:  
 Robbyn Cherter Whitman<sup>87</sup> in 1959  
 Peri Ann Whitman<sup>88</sup> in 1960  
*This family is shown as family tree 29.*
176. CLAUDETTE IRENE CORLETT (James's great-great-great-grandson's wife).  
 Nelson Chester Whitman<sup>174</sup> married Claudette Irene Corlett. They had one son:  
 Marcus Pine Whitman<sup>89</sup> in 1962  
*This family is shown as family tree 30.*
177. LORRAINE MADDEN (James's great-great-great-grandson's wife) was born in 1962.  
 Nelson Chester Whitman<sup>174</sup> married Lorraine Madden.
178. BOYD DAVID WHITMAN (James's great-great-great-grandson) was born in 1940 in BigPiney, Sublette, Wyoming, USA to Bruce Douglas Whitman<sup>276</sup> and Frances Amonda Davidson<sup>275</sup>, as shown in family tree 52.
179. CAROLYN M THOMPSON (James's great-great-great-grandson's wife).  
 Boyd David Whitman<sup>178</sup> married Carolyn M Thompson. They had three children:  
 Micheal Gerald Sturm Whitman<sup>90</sup> in 1968  
 Patrick Keith Whitman<sup>91</sup> in 1969  
 Nathanielle Rebecca Whitman<sup>92</sup> in 1973  
*This family is shown as family tree 31.*
180. RICHARD WARD WHITMAN (James's great-great-great-grandson) was born in 1941 in BigPiney, Sublette, Wyoming, USA to Bruce Douglas Whitman<sup>276</sup> and Frances Amonda Davidson<sup>275</sup>, as shown in family tree 52.
181. ROBIN KNIPP JOUETT (James's great-great-great-grandson's wife).  
 Richard Ward Whitman<sup>180</sup> married Robin Knipp Jouett. They had two children:  
 Grant Douglas Whitman<sup>93</sup> in 1967  
 Gail Robin Whitman<sup>94</sup> in 1968  
*This family is shown as family tree 32.*
182. CHARLOTTE LOUIZE WHITMAN (James's great-great-great-granddaughter) was born in 1944 in BigPiney, Sublette, Wyoming, USA to Bruce Douglas Whitman<sup>276</sup> and Frances Amonda Davidson<sup>275</sup>, as shown in family tree 52.
183. JOSEPH GRANT BARTLETT (James's great-great-great-granddaughter's husband).  
 Joseph Grant Bartlett married Charlotte Louize Whitman<sup>182</sup>. They had three children:  
 Tori Dawn Bartlett<sup>95</sup> in 1963  
 Travis Darryl Bartlett<sup>96</sup> in 1969  
 Trevor David Bartlett<sup>97</sup> in 1974  
*This family is shown as family tree 33.*
184. MARCELLA ANN WHITMAN (James's great-great-great-granddaughter) was born in 1946 to Bruce Douglas Whitman<sup>276</sup> and Frances Amonda Davidson<sup>275</sup>, as shown in family tree 52.
185. TOMMY M THOMPSON (James's great-great-great-granddaughter's husband).  
 Tommy M Thompson married Marcella Ann Whitman<sup>184</sup>. They had one son:  
 Bradly Tommy Thompson<sup>98</sup> in 1966  
*This family is shown as family tree 34.*
186. PHILLIS LANA WHITMAN (James's great-great-great-granddaughter) was born in 1948 to Bruce Douglas Whitman<sup>276</sup> and Frances Amonda Davidson<sup>275</sup>, as shown in family tree 52.
187. FRED WINTON SMITH (James's great-great-great-granddaughter's husband).  
 Fred Winton Smith married Phillis Lana Whitman<sup>186</sup>. They had two children:  
 Fred Winton Smith<sup>99</sup> in 1967  
 Collin Wade Whitman<sup>100</sup> in 1969  
*This family is shown as family tree 35.*
188. LAUREL ALICE WHITMAN (James's great-great-great-granddaughter) was born in 1952 to Bruce Douglas Whitman<sup>276</sup> and Frances Amonda Davidson<sup>275</sup>, as shown in family tree 52.  
 (Laurel married twice. She was married to Stanley Howard Self<sup>189</sup> and Everett Michael Corlett<sup>190</sup>.)
189. STANLEY HOWARD SELF (James's great-great-great-granddaughter's husband).  
 Stanley Howard Self married Laurel Alice Whitman<sup>188</sup>. They had three children:  
 Stuart Branson Self<sup>101</sup> in 1974  
 Ian Mathew Self<sup>102</sup> in 1975  
 Ashley Chester Self<sup>103</sup> in 1977  
*This family is shown as family tree 36.*
190. EVERETT MICHAEL CORLETT (James's great-great-great-granddaughter's husband).

Everett Michael Corlett married Laurel Alice Whitman<sup>188</sup>.

191. CHARLES WHITMAN (James's great-great-great-grandson) was born in 1957 to Bruce Douglas Whitman<sup>276</sup> and Frances Amonda Davidson<sup>275</sup>, as shown in family tree 52.
192. ROBERT HARRY ROGERSON (James's great-great-great-grandson) was born in 1942 to Robert Orrin Rogerson<sup>278</sup> and Vita Maude Davidson<sup>277</sup>, as shown in family tree 53. Robert died in 1953, aged about 11.
193. WILMA ELAINE ROGERSON (James's great-great-great-granddaughter) was born in 1948 to Robert Orrin Rogerson<sup>278</sup> and Vita Maude Davidson<sup>277</sup>, as shown in family tree 53. Wilma died in 1965, aged about 17.
194. RUTH ORRINE ROGERSON (James's great-great-great-granddaughter) was born in 1949 to Robert Orrin Rogerson<sup>278</sup> and Vita Maude Davidson<sup>277</sup>, as shown in family tree 53.
195. ROGER CAYLOR (James's great-great-great-granddaughter's husband).  
Roger Caylor married Ruth Orrine Rogerson<sup>194</sup>.
196. KATHERYNE LOUIZE BLACKBURN (James's great-great-great-granddaughter) was born in 1946 to Harvey Alton Blackburn<sup>282</sup> and Louize Gertrude Davidson<sup>281</sup>, as shown in family tree 54.
197. EDWARD J MCCREA (James's great-great-great-granddaughter's husband) was born in 1945.  
Edward J McCrea married Katheryne Louize Blackburn<sup>196</sup>.
198. HARVEY DAVID BLACKBURN (James's great-great-great-grandson) was born in 1953 to Harvey Alton Blackburn<sup>282</sup> and Louize Gertrude Davidson<sup>281</sup>, as shown in family tree 54.
199. CELESTE MARIE HOFFMAN (James's great-great-great-grandson's wife) was born in 1963.  
Harvey David Blackburn<sup>198</sup> married Celeste Marie Hoffman.
200. DANIEL CLARK DAVIDSON (James's great-great-great-grandson) was born in 1949 to Chester Clark Davidson<sup>283</sup> and Norma Hilda Dadisman<sup>284</sup>, as shown in family tree 55.
201. JEAN MARIE DAVIDSON (James's great-great-great-granddaughter) was born in 1954 to Chester Clark Davidson<sup>283</sup> and Norma Hilda Dadisman<sup>284</sup>, as shown in family tree 55.
202. GARRETT DAVID ACKERSON (James's great-great-great-grandson) was born in 1943 to Walter Cecil Ackerson<sup>286</sup> and Eleanora Alice Davidson<sup>285</sup>, as shown in family tree 56.
203. EVELYN ANDERSON (James's great-great-great-grandson's wife) was born in 1948.  
Garrett David Ackerson<sup>202</sup> married Evelyn Anderson.
204. TERRY WALTER ACKERSON (James's great-great-great-grandson) was born in 1945 to Walter Cecil Ackerson<sup>286</sup> and Eleanora Alice Davidson<sup>285</sup>, as shown in family tree 56.  
(Terry married twice. He was married to Kay Harding<sup>205</sup> and Patricia Cox<sup>206</sup>.)
205. KAY HARDING (James's great-great-great-grandson's wife) was born in 1946.  
Terry Walter Ackerson<sup>204</sup> married Kay Harding.
206. PATRICIA COX (James's great-great-great-grandson's wife) was born in 1946.  
Terry Walter Ackerson<sup>204</sup> married Patricia Cox.
207. WESLEY CECIL ACKERSON (James's great-great-great-grandson) was born in 1947 to Walter Cecil Ackerson<sup>286</sup> and Eleanora Alice Davidson<sup>285</sup>, as shown in family tree 56.
208. KRISTY LEE ARY (James's great-great-great-grandson's wife) was born in 1955.  
Wesley Cecil Ackerson<sup>207</sup> married Kristy Lee Ary.
209. DANNY RAY ACKERSON (James's great-great-great-grandson) was born in 1948 to Walter Cecil Ackerson<sup>286</sup> and Eleanora Alice Davidson<sup>285</sup>, as shown in family tree 56.
210. NANCY SUE KURTH (James's great-great-great-grandson's wife) was born in 1950.  
Danny Ray Ackerson<sup>209</sup> married Nancy Sue Kurth.
211. SUELLEN LOUISE DAVIDSON (James's great-great-great-granddaughter) was born in 1951 to Charles Daniel Davidson<sup>287</sup> and Earlene Dee Noller<sup>288</sup>, as shown in family tree 57.
212. JOHN ELLERY MASTERS (James's great-great-great-granddaughter's husband) was born in 1953.  
John Ellery Masters married Suellen Louise Davidson<sup>211</sup>.
213. DEBORAH JEANE DAVIDSON (James's great-great-great-granddaughter) was born to Charles Daniel Davidson<sup>287</sup> and Earlene Dee Noller<sup>288</sup>, as shown in family tree 57.  
(Deborah married twice. She was married to Charles William Nation, Jr.<sup>214</sup> and Gerald Noller Tomayer<sup>215</sup>.)

214. CHARLES WILLIAM NATION, JR. (James's great-great-great-granddaughter's husband).  
Charles William Nation, Jr. married Deborah Jeane Davidson<sup>213</sup>.
215. GERALD NOLLER TOMAYER (James's great-great-great-granddaughter's husband) was born in 1960.  
Gerald Noller Tomayer married Deborah Jeane Davidson<sup>213</sup>.
216. CHARLES NOLLER DAVIDSON (James's great-great-great-grandson) was born in 1960 to Charles Daniel Davidson<sup>287</sup> and Earlene Dee Noller<sup>288</sup>, as shown in family tree 57.
217. TONIA JENKINS (James's great-great-great-grandson's wife).  
Charles Noller Davidson<sup>216</sup> married Tonia Jenkins.
218. KEREN LYNNE HARNED (James's great-great-great-granddaughter) was born in 1963 to David Debernardi Harned<sup>290</sup> and Myrtle Rae Davidson<sup>289</sup>, as shown in family tree 58.
219. RICHARD LEE WELLS (James's great-great-great-granddaughter's husband) was born in 1962.  
Richard Lee Wells married Keren Lynne Harned<sup>218</sup>.
220. KATHLEEN MARIE REDMAN (James's great-great-great-granddaughter) was born in 1965 to Ronald Clark Redman<sup>291</sup> and Myrtle Rae Davidson<sup>289</sup>, as shown in family tree 59.  
(Kathleen married three times. She was married to Timothy Tol Johnson<sup>221</sup>, Richard Ferrin<sup>222</sup> and Jamie Paul Shoemaker<sup>223</sup>.)
221. TIMOTHY TOL JOHNSON (James's great-great-great-granddaughter's husband).  
Timothy Tol Johnson married Kathleen Marie Redman<sup>220</sup>.
222. RICHARD FERRIN (James's great-great-great-granddaughter's husband).  
Richard Ferrin married Kathleen Marie Redman<sup>220</sup>.
223. JAMIE PAUL SHOEMAKER (James's great-great-great-granddaughter's husband).  
Jamie Paul Shoemaker married Kathleen Marie Redman<sup>220</sup>.
224. KATHRYN VICTORIA REDMAN (James's great-great-great-granddaughter) was born in 1970 to Ronald Clark Redman<sup>291</sup> and Myrtle Rae Davidson<sup>289</sup>, as shown in family tree 59.
225. RONNIE WESLEY REDMAN (James's great-great-great-grandson) was born in 1974 to Ronald Clark Redman<sup>291</sup> and Myrtle Rae Davidson<sup>289</sup>, as shown in family tree 59.
226. LINDA ANN CAIRNS (James's great-great-great-granddaughter) was born in 1950 to Jack Lavoy Cairns<sup>294</sup> and Beverly Ann Johnson<sup>295</sup>, as shown in family tree 60.
227. RONALD OTIS PAGE (James's great-great-great-granddaughter's husband) was born in 1950 in Colorado Springs, El Paso, Colorado, USA.  
Ronald Otis Page married Linda Ann Cairns<sup>226</sup>. They had three children:  
Thomas Elliott Page<sup>104</sup> in 1971  
Johnathan Jack Page<sup>105</sup> in 1973  
Donald Grant Page<sup>106</sup> in 1975  
*This family is shown as family tree 37.*
228. CHRISTINE MARIE CAIRNS (James's great-great-great-granddaughter) was born in 1951 in Rawlins, Carbon, Wyoming, USA to Jack Lavoy Cairns<sup>294</sup> and Beverly Ann Johnson<sup>295</sup>, as shown in family tree 60.
229. CRAIG CAMPBELL (James's great-great-great-granddaughter's husband) was born in 1955.  
Craig Campbell married Christine Marie Cairns<sup>228</sup>. They had three children:  
Triana Marie Campbell<sup>107</sup> in 1978  
Holly Ann Campbell<sup>108</sup> in 1980  
Eric Raymond Campbell<sup>109</sup> in 1985  
*This family is shown as family tree 38.*
230. JACK LAVOY CAIRNS, JR. (James's great-great-great-grandson) was born in 1953 in Rock Springs, Sweetwater, Wyoming, USA to Jack Lavoy Cairns<sup>294</sup> and Beverly Ann Johnson<sup>295</sup>, as shown in family tree 60.
231. REBECCA CASSLER (James's great-great-great-grandson's wife) was born in 1955.  
Jack Lavoy Cairns, Jr.<sup>230</sup> married Rebecca Cassler. They had two children:  
Rachel Elizabeth Cairns<sup>110</sup> in 1979  
Mary Melissa Cairns<sup>111</sup> in 1983  
*This family is shown as family tree 39.*
232. ELIZABETH KAY CAIRNS (James's great-great-great-granddaughter) was born in 1954 in Rawlins, Carbon, Wyoming, USA to Jack Lavoy Cairns<sup>294</sup> and Beverly Ann Johnson<sup>295</sup>, as shown in family tree 60.
233. ALAN HANSEN (James's great-great-great-granddaughter's husband).



Alan Hansen married Elizabeth Kay Cairns<sup>232</sup>. They had five children:

- Jeremy Alan Hansen<sup>112</sup> in 1975
- Aaron Wayne Hansen<sup>113</sup> in 1976
- Michael Brent Hansen<sup>114</sup> in 1979
- Amy Nicole Hansen<sup>115</sup> in 1981
- Jacob Karl Hansen<sup>116</sup> in 1983

*This family is shown as family tree 40.*

234. WILLIAM WAYNE CAIRNS (James's great-great-great-grandson) was born in 1955 in Rawlins, Carbon, Wyoming, USA to Jack Lavoy Cairns<sup>294</sup> and Beverly Ann Johnson<sup>295</sup>, as shown in family tree 60.

235. KAE PORTER (James's great-great-great-grandson's wife) was born in 1957 in Ceder City, Iron, Utah, USA.

William Wayne Cairns<sup>234</sup> married Kae Porter. They had three children:

- Dorci Kae Cairns<sup>117</sup> in 1983
- Jace William Cairns<sup>118</sup> in 1988
- Brindi Michelle Cairns<sup>119</sup> in 1991

*This family is shown as family tree 41.*

236. REBECCA GAY CAIRNS (James's great-great-great-granddaughter) was born in 1956 in Rawlins, Carbon, Wyoming, USA to Jack Lavoy Cairns<sup>294</sup> and Beverly Ann Johnson<sup>295</sup>, as shown in family tree 60.

237. JOHN ELLERY COOPER (James's great-great-great-granddaughter's husband) was born in 1954 in Yonkers, New York, USA.

John Ellery Cooper married Rebecca Gay Cairns<sup>236</sup>. They had two children:

- Tiffany Anne Cooper<sup>120</sup> in 1977
- Hillary Ranee Cooper<sup>122</sup> in 1978

*This family is shown as family tree 42.*

238. RICHARD NORMAN WILSON (James's great-great-great-grandson) was born in 1953 in Rawlins, Carbon, Wyoming, USA to Albert Norman Wilson<sup>297</sup> and Margaret Faunita Cairns<sup>296</sup>, as shown in family tree 61.

239. KENNETH LOGAN WILSON (James's great-great-great-grandson) was born in 1954 in Rawlins, Carbon, Wyoming, USA to Albert Norman Wilson<sup>297</sup> and Margaret Faunita Cairns<sup>296</sup>, as shown in family tree 61.

240. PHYLLIS ANN WILSON (James's great-great-great-granddaughter) was born in 1955 in Rawlins, Carbon, Wyoming, USA to Albert Norman Wilson<sup>297</sup> and Margaret Faunita Cairns<sup>296</sup>, as shown in family tree 61.

241. CARLIE JEBENS (James's great-great-great-granddaughter's husband).

Carlie Jebens married Phyllis Ann Wilson<sup>240</sup>. They had three children:

- Kreeta Ann Jebens<sup>123</sup> in 1975
- Korey Kay Jebens<sup>124</sup> in 1977
- Carlie Norman Jebens<sup>125</sup> in 1979

*This family is shown as family tree 43.*

242. TYLER MARTIN SCHMELING (James's great-great-great-grandson) was born in 1976 in Weatland, Platte, Wyoming, USA to Craig Martin Schmeling<sup>300</sup> and Judy Ann Cairns<sup>299</sup>, as shown in family tree 62.

243. AMY NICHOLE SCHMELING (James's great-great-great-granddaughter) was born in 1978 in Cheyenne, Laramie, Wyoming, USA to Craig Martin Schmeling<sup>300</sup> and Judy Ann Cairns<sup>299</sup>, as shown in family tree 62.

### Generation of Great-Great-Grandchildren

244. GRACE PETERS (James's great-great-granddaughter) was born to Fred Peters<sup>309</sup> and Rosa Marie Kennaday<sup>308</sup>, as shown in family tree 63.

245. JOHN PETERS (James's great-great-grandson) was born to Fred Peters<sup>309</sup> and Rosa Marie Kennaday<sup>308</sup>, as shown in family tree 63.

246. MABLE VILOTE STEWART (James's great-great-granddaughter) was born in 1906 to Ed Stewart<sup>311</sup> and Anna Ruth Kennaday<sup>310</sup>, as shown in family tree 64.

247. FRANCES LUELLE STEWART (James's great-great-granddaughter) was born in 1909 to Ed Stewart<sup>311</sup> and Anna Ruth Kennaday<sup>310</sup>, as shown in family tree 64.

248. GEORGE MARTIN STEWART (James's great-great-grandson) was born in 1912 to Ed Stewart<sup>311</sup> and Anna Ruth Kennaday<sup>310</sup>, as shown in family tree 64.

249. OLIVE RUTH STEWART (James's great-great-granddaughter) was born in 1921 in Blue Lake, Humboldt, California, USA to Ed Stewart<sup>311</sup> and Anna Ruth Kennaday<sup>310</sup>, as shown in family tree 64.
250. CHARLES LEROY STEWART (James's great-great-grandson) was born in 1929 in Blue Lake, Humboldt, California, USA to Ed Stewart<sup>311</sup> and Anna Ruth Kennaday<sup>310</sup>, as shown in family tree 64. Charles died in 1996, aged about 67.
251. LUCY UNKNOWN (James's great-great-grandson's wife).  
Charles Leroy Stewart<sup>250</sup> married Lucy Unknown.
252. THOMAS EARL KENNADAY (James's great-great-grandson) was born on 7 July 1914 in Saratoga, Carbon, Wyoming, USA to Frank Forest Kennaday<sup>316</sup> and Mable Pierce<sup>317</sup>, as shown in family tree 65.
253. GLADYS ELEANOR REAM (James's great-great-grandson's wife) was born in 1914 in Superior, Colorado, USA. Gladys died in 1990, aged about 76.  
Thomas Earl Kennaday<sup>252</sup>, aged 18, married Gladys Eleanor Ream, aged about 18, on 13 May 1933 in Rawlins, Carbon, Wyoming, USA. They had three children:  
Charlotte Arlene Kennaday<sup>126</sup> in 1933  
Thomas Eugene Kennaday<sup>128</sup> in 1935  
Patty Ray Kennaday<sup>130</sup> in 1937  
*This family is shown as family tree 44.*
254. FLORENCE MAE KENNADAY (James's great-great-granddaughter) was born on 28 June 1917 in Saratoga, Carbon, Wyoming, USA to Frank Forest Kennaday<sup>316</sup> and Mable Pierce<sup>317</sup>, as shown in family tree 65.  
(Florence married twice. She was married to Mr. Bray<sup>255</sup> and Earl N Ramsey<sup>256</sup>.)
255. MR. BRAY (James's great-great-granddaughter's husband).  
Mr. Bray married Florence Mae Kennaday<sup>254</sup>.
256. EARL N RAMSEY (James's great-great-granddaughter's husband) was born in 1911.  
Earl N Ramsey, aged about 24, married Florence Mae Kennaday<sup>254</sup>, aged 18, on 21 October 1935. They had two children:  
Earl Efton (Butch) Ramsey<sup>132</sup> in 1937  
Afton Ernstine (Marier) Ramsey<sup>134</sup>  
*This family is shown as family tree 45.*
257. FOREST JACK KENNADAY (James's great-great-grandson) was born on 22 November 1919 in Saratoga, Carbon, Wyoming, USA to Frank Forest Kennaday<sup>316</sup> and Mable Pierce<sup>317</sup>, as shown in family tree 65.
258. ELLEN (DUDE) STOCKWELL (James's great-great-granddaughter's husband) was born in 1919 in Saratoga, Carbon, Wyoming, USA.  
Ellen (Dude) Stockwell, aged about 25, married Forest Jack Kennaday<sup>257</sup>, aged 25, on 9 June 1945. They had three children:  
Jack Wayne Kennaday<sup>136</sup> in 1939  
Gary Forrest Kennaday<sup>138</sup> in 1942  
Michael Joseph Kennaday<sup>141</sup>  
*This family is shown as family tree 46.*
259. ROSE MARIE KENNADAY (James's great-great-granddaughter) was born on 10 October 1921 in Saratoga, Carbon, Wyoming, USA to Frank Forest Kennaday<sup>316</sup> and Mable Pierce<sup>317</sup>, as shown in family tree 65.
260. CALVIN LOTT (James's great-great-granddaughter's husband).  
Calvin Lott married Rose Marie Kennaday<sup>259</sup>. They had six children:  
Jimmy Ray Lott<sup>143</sup> in 1940  
Rosa Lee Lott<sup>145</sup>  
Calvin Jay Lott<sup>147</sup>  
Mable Bea Lott<sup>149</sup>  
John Lott<sup>152</sup>  
Randy Eugene Lott<sup>153</sup> in 1962  
*This family is shown as family tree 47.*
261. IVA JUNE KENNADAY (James's great-great-granddaughter) was born on 13 June 1923 in Saratoga, Carbon, Wyoming, USA to Frank Forest Kennaday<sup>316</sup> and Mable Pierce<sup>317</sup>, as shown in family tree 65. Iva died on 16 March 2005, aged 81, in Indianapolis, Indiana, USA. She was buried in Carlisle Cemetery, Carlisle, Kentucky.  
Note: *Although my children were born before wedding. This is the true mother and father and God has blessed this union.*
262. JOHN DAVID KELLEY (James's great-great-granddaughter's husband) was born on 28 December 1917 to Talmadge Blane Kelley<sup>442</sup> and Mary Elizabeth Minton<sup>443</sup>. He became a Grocery, Service Station. John died on 21 April 1970, aged 52, of Liver, in Carlisle, Kentucky, USA. He was buried in Carlisle Cemetery, Carlisle Kentucky.  
*[See also: Indirectly related via John David Kelley]*

Note: John D joined the Army on November 19, 1942 in Carlisle Kentucky. Was a Corporal in the 306th unit at Cincinnati, Ohio and served as a Cook at the Pueblo Air Force Base in Salt Lake City. He was Discharged on April 8, 1943 with rank of Corporal. His Serial Number was 35455610 It was a wonderful blessing from God the day he influenced John D to stop the drinking habit and become a real husband and father. We know that it happened through God's help and we send a prayer every day, hour, minute.

John David Kelley, aged 30, married Iva June Kennaday<sup>261</sup>, aged 25, on 8 August 1948 in Flemmingburg, Kentucky, USA. They had two children:

Ronald David Kelley, Sr.<sup>154</sup> in 1943

Carolyn June Kelley<sup>156</sup> in 1945

*This family is shown as family tree 48.*

263. BONNIE JEAN KENNADAY (James's great-great-granddaughter) was born on 6 April 1925 to Frank Forest Kennaday<sup>316</sup> and Mable Pierce<sup>317</sup>, as shown in family tree 65.

(Bonnie married twice. She was married to Gordon Johnson<sup>264</sup> and James Martin Marier<sup>265</sup>.)

264. GORDON JOHNSON (James's great-great-granddaughter's husband).

Gordon Johnson married Bonnie Jean Kennaday<sup>263</sup>. They had two children:

Stanley Johnson<sup>158</sup>

Scott Johnson<sup>159</sup>

*This family is shown as family tree 49.*

265. JAMES MARTIN MARIER (James's great-great-granddaughter's husband) was born on 22 February 1920 in El Vado, Rio Arriba, New Mexico, USA. James died in 1999, aged about 79.

James Martin Marier, aged 28, married Bonnie Jean Kennaday<sup>263</sup>, aged 23, on 6 April 1948. They had two children:

Sherry Jean Marier<sup>160</sup> in 1942

Jane Marie Marier<sup>163</sup> in 1945

*This family is shown as family tree 50.*

266. LINCOLN FRANK KENNADAY (James's great-great-grandson) was born on 9 April 1928 in Saratoga, Carbon, Wyoming, USA to Frank Forest Kennaday<sup>316</sup> and Mable Pierce<sup>317</sup>, as shown in family tree 65.

267. JOAN OLIVIA DEBERNARDI (James's great-great-grandson's wife) was born on 30 April 1929 in Roseburg, Douglas, Oregon, USA.

Lincoln Frank Kennaday<sup>266</sup>, aged 17, married Joan Olivia Debernardi, aged 16, on 25 October 1945. They had four children:

Gary Jo Kennaday<sup>165</sup> in 1946

David Debernardi Kennaday<sup>167</sup> in 1949

Steven Scott Kennaday<sup>169</sup> in 1956

Fredrick Frank Kennaday<sup>172</sup> in 1957

*This family is shown as family tree 51.*

268. WILLIAM C KENNADAY (James's great-great-grandson) was born in 1920 in Saratoga, Carbon, Wyoming, USA to Edward Thomas Kennaday<sup>318</sup> and Alice Mannahan<sup>319</sup>, as shown in family tree 66. William died in 1920 as an infant.

269. JOHN E KENNADAY (James's great-great-grandson) was born in 1927 in Saratoga, Carbon, Wyoming, USA to Edward Thomas Kennaday<sup>318</sup> and Alice Mannahan<sup>319</sup>, as shown in family tree 66. John died in 1927 as an infant.

270. MARY LOU KENNADAY (James's great-great-granddaughter) was born in 1931 in Saratoga, Carbon, Wyoming, USA to Edward Thomas Kennaday<sup>318</sup> and Alice Mannahan<sup>319</sup>, as shown in family tree 66. Mary died in 1972, aged about 41.

271. CATHERINE MARIE KENNADAY (James's great-great-granddaughter) was born in 1931 in Saratoga, Carbon, Wyoming, USA to Edward Thomas Kennaday<sup>318</sup> and Alice Mannahan<sup>319</sup>, as shown in family tree 66. Catherine died in 1936, aged about 5.

272. FRED E KENNADAY (James's great-great-grandson) was born in 1932 in Saratoga, Carbon, Wyoming, USA to Edward Thomas Kennaday<sup>318</sup> and Alice Mannahan<sup>319</sup>, as shown in family tree 66. Fred died in 1933, aged about 1.

273. JAMES KENNADAY (James's great-great-grandson) was born to Edward Thomas Kennaday<sup>318</sup> and Alice Mannahan<sup>319</sup>, as shown in family tree 66.

274. ALICE ANN KENNADAY (James's great-great-granddaughter) was born in 1938 in Saratoga, Carbon, Wyoming, USA to Edward Thomas Kennaday<sup>318</sup> and Alice Mannahan<sup>319</sup>, as shown in family tree 66. Alice died in 1985, aged about 47.

275. FRANCES AMONDA DAVIDSON (James's great-great-granddaughter) was born in 1917 in Denver, Adams, Colorado, USA to Fairfax Harry Davidson<sup>321</sup> and Alice Oda May Kennaday<sup>320</sup>, as shown in family tree 67.

276. BRUCE DOUGLAS WHITMAN (James's great-great-granddaughter's husband) was born in 1920. (Bruce married three times. He was married to Frances Amonda Davidson<sup>275</sup>, Claudette Irene Corlett<sup>475</sup> and Lorraine Madden<sup>476</sup>.)  
*[See also: Indirectly related via Bruce Douglas Whitman]*  
 Bruce Douglas Whitman married Frances Amonda Davidson<sup>275</sup>. They had eight children:  
 Nelson Chester Whitman<sup>174</sup> in 1939  
 Boyd David Whitman<sup>178</sup> in 1940  
 Richard Ward Whitman<sup>180</sup> in 1941  
 Charlotte Louise Whitman<sup>182</sup> in 1944  
 Marcella Ann Whitman<sup>184</sup> in 1946  
 Phillis Lana Whitman<sup>186</sup> in 1948  
 Laurel Alice Whitman<sup>188</sup> in 1952  
 Charles Whitman<sup>191</sup> in 1957  
*This family is shown as family tree 52.*
277. VITA MAUDE DAVIDSON (James's great-great-granddaughter) was born in 1918 in Saratoga, Carbon, Wyoming, USA to Fairfax Harry Davidson<sup>321</sup> and Alice Oda May Kennaday<sup>320</sup>, as shown in family tree 67. (Vita married three times. She was married to Robert Orrin Rogerson<sup>278</sup>, Douglas Turner Cairns<sup>279</sup> and Vyril M Schilling<sup>280</sup>.)
278. ROBERT ORRIN ROGERSON (James's great-great-granddaughter's husband) was born in 1918. Robert Orrin Rogerson married Vita Maude Davidson<sup>277</sup>. They had three children:  
 Robert Harry Rogerson<sup>192</sup> in 1942  
 Wilma Elaine Rogerson<sup>193</sup> in 1948  
 Ruth Orrine Rogerson<sup>194</sup> in 1949  
*This family is shown as family tree 53.*
279. DOUGLAS TURNER CAIRNS (James's great-great-granddaughter's husband). Douglas Turner Cairns married Vita Maude Davidson<sup>277</sup>.
280. VYRIL M SCHILLING (James's great-great-granddaughter's husband). Vyril M Schilling married Vita Maude Davidson<sup>277</sup>.
281. LOUIZE GERTRUDE DAVIDSON (James's great-great-granddaughter) was born in 1920 in Saratoga, Carbon, Wyoming, USA to Fairfax Harry Davidson<sup>321</sup> and Alice Oda May Kennaday<sup>320</sup>, as shown in family tree 67.
282. HARVEY ALTON BLACKBURN (James's great-great-granddaughter's husband) was born in 1915. Harvey Alton Blackburn married Louise Gertrude Davidson<sup>281</sup>. They had two children:  
 Kathyryne Louise Blackburn<sup>196</sup> in 1946  
 Harvey David Blackburn<sup>198</sup> in 1953  
*This family is shown as family tree 54.*
283. CHESTER CLARK DAVIDSON (James's great-great-grandson) was born in 1921 to Fairfax Harry Davidson<sup>321</sup> and Alice Oda May Kennaday<sup>320</sup>, as shown in family tree 67.
284. NORMA HILDA DADISMAN (James's great-great-grandson's wife). Chester Clark Davidson<sup>283</sup> married Norma Hilda Dadisman. They had two children:  
 Daniel Clark Davidson<sup>200</sup> in 1949  
 Jean Marie Davidson<sup>201</sup> in 1954  
*This family is shown as family tree 55.*
285. ELEANORA ALICE DAVIDSON (James's great-great-granddaughter) was born in 1923 to Fairfax Harry Davidson<sup>321</sup> and Alice Oda May Kennaday<sup>320</sup>, as shown in family tree 67.
286. WALTER CECIL ACKERSON (James's great-great-granddaughter's husband) was born in 1913. Walter Cecil Ackerson married Eleanora Alice Davidson<sup>285</sup>. They had four children:  
 Garrett David Ackerson<sup>202</sup> in 1943  
 Terry Walter Ackerson<sup>204</sup> in 1945  
 Wesley Cecil Ackerson<sup>207</sup> in 1947  
 Danny Ray Ackerson<sup>209</sup> in 1948  
*This family is shown as family tree 56.*
287. CHARLES DANIEL DAVIDSON (James's great-great-grandson) was born in 1927 to Fairfax Harry Davidson<sup>321</sup> and Alice Oda May Kennaday<sup>320</sup>, as shown in family tree 67.
288. EARLENE DEE NOLLER (James's great-great-grandson's wife) was born in 1929. Charles Daniel Davidson<sup>287</sup> married Earlene Dee Noller. They had three children:  
 Suellen Louise Davidson<sup>211</sup> in 1951  
 Deborah Jeane Davidson<sup>213</sup>  
 Charles Noller Davidson<sup>216</sup> in 1960  
*This family is shown as family tree 57.*

289. MYRTLE RAE DAVIDSON (James's great-great-granddaughter) was born in 1929 to Fairfax Harry Davidson<sup>321</sup> and Alice Oda May Kennaday<sup>320</sup>, as shown in family tree 67.  
(Myrtle married twice. She was married to David Debernardi Harned<sup>290</sup> and Ronald Clark Redman<sup>291</sup>.)
290. DAVID DEBERNARDI HARNED (James's great-great-granddaughter's husband).  
David Debernardi Harned married Myrtle Rae Davidson<sup>289</sup>. They had one daughter:  
Keren Lynne Harned<sup>218</sup> in 1963  
*This family is shown as family tree 58.*
291. RONALD CLARK REDMAN (James's great-great-granddaughter's husband) was born in 1935.  
Ronald Clark Redman married Myrtle Rae Davidson<sup>289</sup>. They had three children:  
Kathleen Marie Redman<sup>220</sup> in 1965  
Kathryn Victoria Redman<sup>224</sup> in 1970  
Ronnie Wesley Redman<sup>225</sup> in 1974  
*This family is shown as family tree 59.*
292. FRANCES ANN KENNADAY (James's great-great-granddaughter) was born to Charles Fredrick Kennaday<sup>322</sup> and Margaret Bays<sup>323</sup>, as shown in family tree 68.
293. THOMAS DEAN LUCAS (James's great-great-granddaughter's husband).  
Thomas Dean Lucas married Frances Ann Kennaday<sup>292</sup>.
294. JACK LAVOY CAIRNS (James's great-great-grandson) was born in 1930 in Rawlins, Carbon, Wyoming, USA to Logan Turner Cairns<sup>325</sup> and Emma Helen Kennaday<sup>324</sup>, as shown in family tree 69.
295. BEVERLY ANN JOHNSON (James's great-great-grandson's wife) was born in 1928 in Hanna, Carbon, Wyoming, USA.  
Jack Lavoy Cairns<sup>294</sup> married Beverly Ann Johnson. They had six children:  
Linda Ann Cairns<sup>226</sup> in 1950  
Christine Marie Cairns<sup>228</sup> in 1951  
Jack Lavoy Cairns, Jr.<sup>230</sup> in 1953  
Elizabeth Kay Cairns<sup>232</sup> in 1954  
William Wayne Cairns<sup>234</sup> in 1955  
Rebecca Gay Cairns<sup>236</sup> in 1956  
*This family is shown as family tree 60.*
296. MARGARET FAUNITA CAIRNS (James's great-great-granddaughter) was born in 1933 in Rawlins, Carbon, Wyoming, USA to Logan Turner Cairns<sup>325</sup> and Emma Helen Kennaday<sup>324</sup>, as shown in family tree 69.
297. ALBERT NORMAN WILSON (James's great-great-granddaughter's husband).  
Albert Norman Wilson married Margaret Faunita Cairns<sup>296</sup>. They had three children:  
Richard Norman Wilson<sup>238</sup> in 1953  
Kenneth Logan Wilson<sup>239</sup> in 1954  
Phyllis Ann Wilson<sup>240</sup> in 1955  
*This family is shown as family tree 61.*
298. DOROTHY LARRAINE CAIRNS (James's great-great-granddaughter) was born in 1941 in Rawlins, Carbon, Wyoming, USA to Logan Turner Cairns<sup>325</sup> and Emma Helen Kennaday<sup>324</sup>, as shown in family tree 69. Dorothy died in 1942, aged about 1.
299. JUDY ANN CAIRNS (James's great-great-granddaughter) was born in 1946 in Rawlins, Carbon, Wyoming, USA to Logan Turner Cairns<sup>325</sup> and Emma Helen Kennaday<sup>324</sup>, as shown in family tree 69.
300. CRAIG MARTIN SCHMELING (James's great-great-granddaughter's husband) was born in 1945 in Whittemore, Platte, Wyoming, USA.  
Craig Martin Schmeling married Judy Ann Cairns<sup>299</sup>. They had two children:  
Tyler Martin Schmeling<sup>242</sup> in 1976  
Amy Nichole Schmeling<sup>243</sup> in 1978  
*This family is shown as family tree 62.*
301. JACK J KENNADAY (James's great-great-grandson) was born on 18 September 1938 in Saratoga, Carbon, Wyoming, USA to Loyd Andrew Kennaday<sup>326</sup> and Inez Henderson<sup>327</sup>, as shown in family tree 70.
302. CARL L KENNADAY (James's great-great-grandson) was born on 18 December 1940 in Saratoga, Carbon, Wyoming, USA to Loyd Andrew Kennaday<sup>326</sup> and Inez Henderson<sup>327</sup>, as shown in family tree 70.
303. CAROL BRUGUS (James's great-great-grandson's wife).  
Carl L Kennaday<sup>302</sup>, aged about 33, married Carol Brugus in 1974.
304. JOY L KENNADAY (James's great-great-granddaughter) was born on 17 April 1942 in Saratoga, Carbon, Wyoming, USA to Loyd Andrew Kennaday<sup>326</sup> and Inez Henderson<sup>327</sup>, as shown in family tree 70.

305. JOHN JENNINGS (James's great-great-granddaughter's husband).  
John Jennings married Joy L Kennaday<sup>304</sup>, aged about 19, in 1961.
306. DONALD FAY KENNADAY (James's great-great-grandson) was born on 18 May 1944 in Saratoga, Carbon, Wyoming, USA to Loyd Andrew Kennaday<sup>326</sup> and Inez Henderson<sup>327</sup>, as shown in family tree 70.

### Generation of Great-Grandchildren

307. SARAH ELIZABETH KENNADAY (James's great-granddaughter) was born on 1 November 1884 in Ceder Vale, Chautauqua, Kansas, USA to Charles Alonzo Kennaday<sup>329</sup> and Frances Elizabeth Kennedy<sup>330</sup>, as shown in family tree 71. Sarah died on 1 November 1884 as an infant.
308. ROSA MARIE KENNADAY (James's great-granddaughter) was born on 22 January 1886 in Ceder Vale, Chautauqua, Kansas, USA to Charles Alonzo Kennaday<sup>329</sup> and Frances Elizabeth Kennedy<sup>330</sup>, as shown in family tree 71. Rosa died on 22 July 1907, aged 21, in Saratoga, Wyoming.
309. FRED PETERS (James's great-granddaughter's husband).  
Fred Peters married Rosa Marie Kennaday<sup>308</sup>, aged 18, on 7 March 1904 in Saratoga, Wyoming. They had two children:  
Grace Peters<sup>244</sup>  
John Peters<sup>245</sup>  
*This family is shown as family tree 63.*
310. ANNA RUTH KENNADAY (James's great-granddaughter) was born on 30 January 1888 in Ceder Vale, Chautauqua, Kansas, USA to Charles Alonzo Kennaday<sup>329</sup> and Frances Elizabeth Kennedy<sup>330</sup>, as shown in family tree 71. Anna died on 6 November 1959, aged 71, in Ceder Vale, Chautauqua, Kansas, USA.
311. ED STEWART (James's great-granddaughter's husband).  
Ed Stewart married Anna Ruth Kennaday<sup>310</sup>, aged 17, on 30 September 1905. They had five children:  
Mable Vilote Stewart<sup>246</sup> in 1906  
Frances Luella Stewart<sup>247</sup> in 1909  
George Martin Stewart<sup>248</sup> in 1912  
Olive Ruth Stewart<sup>249</sup> in 1921  
Charles Leroy Stewart<sup>250</sup> in 1929  
*This family is shown as family tree 64.*
312. ALONSO KENNADAY (James's great-grandson) was born on 4 April 1889 in Ceder Vale, Chautauqua, Kansas, USA to Charles Alonzo Kennaday<sup>329</sup> and Frances Elizabeth Kennedy<sup>330</sup>, as shown in family tree 71. Alonso died on 4 April 1889 as an infant.
313. HENRY GEORGE KENNADAY (James's great-grandson) was born on 11 May 1890 in Ceder Vale, Chautauqua, Kansas, USA to Charles Alonzo Kennaday<sup>329</sup> and Frances Elizabeth Kennedy<sup>330</sup>, as shown in family tree 71. Henry died on 20 May 1901, aged 11.
314. HARRY OTIS KENNADAY (James's great-grandson) was born on 8 October 1892 in Saratoga, Carbon, Wyoming, USA to Charles Alonzo Kennaday<sup>329</sup> and Frances Elizabeth Kennedy<sup>330</sup>, as shown in family tree 71. Harry died on 25 April 1940, aged 47, in Cheyenne, Laramie, Wyoming, USA. He was buried in Saratoga, Wyoming.
315. ESTER WEIBEL (James's great-grandson's wife).  
Harry Otis Kennaday<sup>314</sup> married Ester Weibel.
316. FRANK FOREST KENNADAY (James's great-grandson) was born on 6 November 1893 in Saratoga, Carbon, Wyoming, USA to Charles Alonzo Kennaday<sup>329</sup> and Frances Elizabeth Kennedy<sup>330</sup>, as shown in family tree 71. Frank died on 11 November 1955, aged 62.  
*Note: Forest's dad would get up at 5:00 AM in the morning and get everybody up and delegate chores to all the family even the girls had outside chores. After he delegated the chores he would go and take a nap until breakfast was ready. Forest didn't think that this was fair and even after he was grown he still didn't think this was fair. When Forest was only eleven and his brother Ed was age nine their father got them a job herding sheep. His dad would pick up their check and they wouldn't see a dime of the money. Forest said that these were hard times, especially at night, they were really scared. Forest had just finished the third grade when his dad put him out to work and no more schooling.*
317. MABLE PIERCE (James's great-grandson's wife) was born on 5 January 1897 in Denver, Colorado to Thomas Earl Pearce<sup>479</sup> and Mary Adele Lambs-Cobb<sup>481</sup>. Mable died on 27 May 1940, aged 43, in Saratoga, Carbon, Wyoming, USA.  
*[See also: Indirectly related via Mable Pierce]*

Note: When Mable and her Sister Alice were small girls their father Thomas and wife Mary Pearce left Denver and moved to Saratoga and homesteaded a piece of land outside of Saratoga toward the Rocky Mountains. It wasn't long after that Mary left Thomas and got custody of us. Thomas didn't stay in Saratoga long and when he decided to leave, he stole the two daughters and took them back to Denver with him. He had to work so he put the girls in an orphanage there and paid for their room and board at the orphanage. We cried for our mother a lot but my sister Alice was a great comfort to me at this time. Alice didn't like spinach so she wouldn't eat it when they put it on her plate. They kept putting it on her plate until she decided to eat it and she learned to like it while she was there. I don't know when Mary got her daughters back, but eventually we were back together in Saratoga, Wyoming. Mary went through the tenth grade in Saratoga at that time that was as far as high school went. She played on the basket ball team at Saratoga High. She was also an accomplished horseman. Horses were the only means of transportation when she was growing up. She played a mandolin and had a good singing voice. She sang at her church and sang many solos, but her husband Frank couldn't carry a tune. All of her babies were born at home.

Notes prepared by: Florence Kennaday.

Frank Forest Kennaday<sup>316</sup>, aged 19, married Mable Pierce, aged 16, on 4 July 1913. They had seven children:

Thomas Earl Kennaday<sup>252</sup> in 1914

Florence Mae Kennaday<sup>254</sup> in 1917

Forest Jack Kennaday<sup>257</sup> in 1919

Rose Marie Kennaday<sup>259</sup> in 1921

Iva June Kennaday<sup>261</sup> in 1923

Bonnie Jean Kennaday<sup>263</sup> in 1925

Lincoln Frank Kennaday<sup>266</sup> in 1928

*This family is shown as family tree 65.*

318. EDWARD THOMAS KENNADAY (James's great-grandson) was born on 9 October 1895 in Saratoga, Carbon, Wyoming, USA to Charles Alonzo Kennaday<sup>329</sup> and Frances Elizabeth Kennedy<sup>330</sup>, as shown in family tree 71. Edward died on 16 October 1951, aged 56.

319. ALICE MANNAHAN (James's great-grandson's wife) was born in 1900 in Saratoga, Carbon, Wyoming, USA. Alice died in 1956, aged about 56.

Edward Thomas Kennaday<sup>318</sup>, aged 22, married Alice Mannahan, aged about 18, on 11 August 1918. They had seven children:

William C Kennaday<sup>268</sup> in 1920

John E Kennaday<sup>269</sup> in 1927

Mary Lou Kennaday<sup>270</sup> in 1931

Catherine Marie Kennaday<sup>271</sup> in 1931

Fred E Kennaday<sup>272</sup> in 1932

James Kennaday<sup>273</sup>

Alice Ann Kennaday<sup>274</sup> in 1938

*This family is shown as family tree 66.*

320. ALICE ODA MAY KENNADAY (James's great-granddaughter) was born on 13 April 1897 in Saratoga, Carbon, Wyoming, USA to Charles Alonzo Kennaday<sup>329</sup> and Frances Elizabeth Kennedy<sup>330</sup>, as shown in family tree 71. Alice died on 6 December 1979, aged 82, in Rawlins, Carbon, Wyoming, USA.

321. FAIRFAX HARRY DAVIDSON (James's great-granddaughter's husband) was born in 1894. Fairfax died in 1967, aged about 73.

Fairfax Harry Davidson, aged about 21, married Alice Oda May Kennaday<sup>320</sup>, aged 19, on 11 May 1916. They had seven children:

Frances Amonda Davidson<sup>275</sup> in 1917

Vita Maude Davidson<sup>277</sup> in 1918

Louize Gertrude Davidson<sup>281</sup> in 1920

Chester Clark Davidson<sup>283</sup> in 1921

Eleanora Alice Davidson<sup>285</sup> in 1923

Charles Daniel Davidson<sup>287</sup> in 1927

Myrtle Rae Davidson<sup>289</sup> in 1929

*This family is shown as family tree 67.*

322. CHARLES FREDRICK KENNADAY (James's great-grandson) was born on 30 November 1898 in Saratoga, Carbon, Wyoming, USA to Charles Alonzo Kennaday<sup>329</sup> and Frances Elizabeth Kennedy<sup>330</sup>, as shown in family tree 71. Charles died on 6 December 1961, aged 63.

323. MARGARET BAYS (James's great-grandson's wife).

Charles Fredrick Kennaday<sup>322</sup>, aged 34, married Margaret Bays on 18 July 1933. They had one daughter:

Frances Ann Kennaday<sup>292</sup>

*This family is shown as family tree 68.*

324. EMMA HELEN KENNADAY (James's great-granddaughter) was born on 8 December 1905 in Saratoga, Carbon, Wyoming, USA to Charles Alonzo Kennaday<sup>329</sup> and Frances Elizabeth Kennedy<sup>330</sup>, as shown in family tree 71. Emma died on 26 August 1988, aged 82, in Rawlins, Carbon, Wyoming, USA. She was buried in Aug 30, 1988 Rawlins, Wyoming.
325. LOGAN TURNER CAIRNS (James's great-granddaughter's husband) was born in 1894 in Rawlins, Carbon, Wyoming, USA. Logan died in 1968, aged about 74.  
Logan Turner Cairns, aged about 31, married Emma Helen Kennaday<sup>324</sup>, aged 19, on 3 December 1925 in Denver, Denver, Colorado, USA. They had four children:  
Jack Lavoy Cairns<sup>294</sup> in 1930  
Margaret Faunita Cairns<sup>296</sup> in 1933  
Dorothy Lorraine Cairns<sup>298</sup> in 1941  
Judy Ann Cairns<sup>299</sup> in 1946  
*This family is shown as family tree 69.*
326. LOYD ANDREW KENNADAY (James's great-grandson) was born on 2 August 1903 in Saratoga, Carbon, Wyoming, USA to Andrew Jackson Kennaday<sup>337</sup> and Anna Marshal<sup>338</sup>, as shown in family tree 72. Loyd died on 10 December 1983, aged 80.
327. INEZ HENDERSON (James's great-grandson's wife) was born on 3 February 1915. Inez died on 22 September 1991, aged 76, in Saratoga, Carbon, Wyoming, USA.  
Loyd Andrew Kennaday<sup>326</sup>, aged 34, married Inez Henderson, aged 22, on 23 October 1937 in Saratoga, Carbon, Wyoming, USA. They had four children:  
Jack J Kennaday<sup>301</sup> in 1938  
Carl L Kennaday<sup>302</sup> in 1940  
Joy L Kennaday<sup>304</sup> in 1942  
Donald Fay Kennaday<sup>306</sup> in 1944  
*This family is shown as family tree 70.*
328. FAY KENNADAY (James's great-granddaughter) was born on 14 June 1907 in Saratoga, Carbon, Wyoming, USA to Andrew Jackson Kennaday<sup>337</sup> and Anna Marshal<sup>338</sup>, as shown in family tree 72. Fay died on 23 May 1974, aged 66.  
Note: *Fay Killed a Bear with a 22 when she was only 12 years old.*

### Generation of Grandchildren

329. CHARLES ALONZO KENNADAY (James's grandson) was born on 8 November 1856 in Clay, Kentucky, USA to John Hudson Kennaday<sup>340</sup> and Anne Elizabeth Van Orsdel<sup>341</sup>, as shown in family tree 73. He became a Rancher, Cowboy, Policeman. Charles died on 6 December 1940, aged 84, in Saratoga, Carbon, Wyoming, USA. He was buried in Dec. 9 1940 at Saratoga, Carbon, Wyoming, USA.  
Note: *My brother Billy and sister Emma used to come and visit occasionally. When he was in his twenties he roade the Chisolm Trail on cattle drives where he meet his wife. They were married on November 11, 1883. In 1891 Charles & Frances left Kansas and moved to Saratoga, Wyoming. Charles pursued several occupations there, Rancher, Cowboy & Policeman. Charles also had a brother Jack that settled near Saratoga on a ranch. He had a ranch near his brother on Ceder Creek, not to far from Saratoga , about 16 miles. A mountain peak in that area is named after the two brothers. (Kennaday Peak).*
330. FRANCES ELIZABETH KENNEDY (James's grandson's wife) was born on 19 September 1864 in Zaleski, Venton, Ohio, USA to Jesse Rufus Kennedy<sup>514</sup> and Sarah Ann Ankrom<sup>515</sup>. Frances died on 10 June 1938, aged 73, in Saratoga, Carbon, Wyoming, USA. She was buried in June 13 1938 Saratoga, Wyoming.  
[See also: *Indirectly related via Frances Elizabeth Kennedy*]  
Note: *When Frances was five years old , she and her parents moved to Ceder Vale Kansas in 1869. She became a member of the Church of Christ in Ceder Vale.*  
Charles Alonzo Kennaday<sup>329</sup>, aged 27, married Frances Elizabeth Kennedy, aged 19, on 11 November 1883 in Cedarvale, Chauauqua, Kansas, USA at Chiurch of Crist. They had eleven children:  
Sarah Elizabeth Kennaday<sup>307</sup> in 1884  
Rosa Marie Kennaday<sup>308</sup> in 1886  
Anna Ruth Kennaday<sup>310</sup> in 1888  
Alonso Kennaday<sup>312</sup> in 1889  
Henry George Kennaday<sup>313</sup> in 1890  
Harry Otis Kennaday<sup>314</sup> in 1892  
Frank Forest Kennaday<sup>316</sup> in 1893  
Edward Thomas Kennaday<sup>318</sup> in 1895  
Alice Oda May Kennaday<sup>320</sup> in 1897  
Charles Fredrick Kennaday<sup>322</sup> in 1898  
Emma Helen Kennaday<sup>324</sup> in 1905  
*This family is shown as family tree 71.*



331. JAMES EDWARD KENNADAY (James's grandson) was born on 15 July 1858 in Lexington, Mclean, Illinois, USA to John Hudson Kennaday<sup>340</sup> and Anne Elizabeth Van Orsdel<sup>341</sup>, as shown in family tree 73. James died on 6 June 1934, aged 75.
332. IDA JANE KENNADAY (James's granddaughter) was born on 4 April 1861 in Lexington, Mclean, Illinois, USA to John Hudson Kennaday<sup>340</sup> and Anne Elizabeth Van Orsdel<sup>341</sup>, as shown in family tree 73. Ida died on 5 April 1883, aged 22.
333. MARY V KENNADAY (James's granddaughter) was born on 12 January 1868 in Cherokee Nation, USA to John Hudson Kennaday<sup>340</sup> and Anne Elizabeth Van Orsdel<sup>341</sup>, as shown in family tree 73. Mary died on 4 October 1869, aged 1.
334. JOHN W KENNADAY (James's grandson) was born on 5 November 1870 in Springfield, Green, Missouri, USA to John Hudson Kennaday<sup>340</sup> and Anne Elizabeth Van Orsdel<sup>341</sup>, as shown in family tree 73. John died on 19 December 1958, aged 88.
335. ANNE E D KENNADAY (James's granddaughter) was born on 29 April 1875 in Lexington, Mclean, Illinois, USA to John Hudson Kennaday<sup>340</sup> and Anne Elizabeth Van Orsdel<sup>341</sup>, as shown in family tree 73. Anne died on 4 October 1960, aged 85.
336. EMMA H KENNADAY (James's granddaughter) was born on 10 September 1875 in Windfield, Cowley, Kansas, USA to John Hudson Kennaday<sup>340</sup> and Anne Elizabeth Van Orsdel<sup>341</sup>, as shown in family tree 73.
337. ANDREW JACKSON KENNADAY (James's grandson) was born on 15 July 1878 in Ceder Vale, Chautauqua, Kansas, USA to John Hudson Kennaday<sup>340</sup> and Anne Elizabeth Van Orsdel<sup>341</sup>, as shown in family tree 73. Andrew died on 8 December 1923, aged 45, in Saratoga, Carbon, Wyoming, USA.  
*Note: Brother To Frank. Kennady PK Named after him. At Wyoming Snowy Range.*
338. ANNA MARSHEL (James's grandson's wife) was born in 1875. Anna died on 8 December 1960, aged about 85, in Saratoga, Carbon, Wyoming, USA.  
 Andrew Jackson Kennaday<sup>337</sup> married Anna Marshel. They had two children:  
 Loyd Andrew Kennaday<sup>326</sup> in 1903  
 Fay Kennaday<sup>328</sup> in 1907  
*This family is shown as family tree 72.*

### Generation of Children

339. JOSEPH BRYSON KENNADAY (James's son) was born on 22 February 1823 to James Kennaday<sup>348</sup> and Sarah Hudson<sup>349</sup>, as shown in family tree 74. Joseph died on 20 May 1899, aged 76.
340. JOHN HUDSON KENNADAY (James's son) was born on 13 June 1825 to James Kennaday<sup>348</sup> and Sarah Hudson<sup>349</sup>, as shown in family tree 74. John died on 8 November 1912, aged 87.
341. ANNE ELIZABETH VAN ORSDEL (James's daughter-in-law) was born on 1 August 1836 in Knox, Indiana, USA to Abram F Van Orsdel, Jr.<sup>570</sup> and Rebecca K Boice<sup>571</sup>. Anne died on 10 February 1916, aged 79, in Carbon, Wyoming, USA. She was buried in Kennaday Ranch.  
 (Anne married twice. She was married to John Williams<sup>550</sup> and John Hudson Kennaday<sup>340</sup>.)  
*[See also: Indirectly related via Anne Elizabeth Van Orsdel]*  
 John Hudson Kennaday<sup>340</sup>, aged 30, married Anne Elizabeth Van Orsdel, aged 19, on 30 August 1855 in Boone, Kentucky, USA. They had eight children:  
 Charles Alonzo Kennaday<sup>329</sup> in 1856  
 James Edward Kennaday<sup>331</sup> in 1858  
 Ida Jane Kennaday<sup>332</sup> in 1861  
 Mary V Kennaday<sup>333</sup> in 1868  
 John W Kennaday<sup>334</sup> in 1870  
 Anne E D Kennaday<sup>335</sup> in 1875  
 Emma H Kennaday<sup>336</sup> in 1875  
 Andrew Jackson Kennaday<sup>337</sup> in 1878  
*This family is shown as family tree 73.*
342. ZARILDA KENNADAY (James's daughter) was born on 16 March 1828 to James Kennaday<sup>348</sup> and Sarah Hudson<sup>349</sup>, as shown in family tree 74.
343. MARY VICKER KENNADAY (James's daughter) was born on 18 March 1834 to James Kennaday<sup>348</sup> and Sarah Hudson<sup>349</sup>, as shown in family tree 74. Mary died on 18 February 1907, aged 72.

344. RACHEL A KENNADAY (James's daughter) was born to James Kennaday<sup>348</sup> and Sarah Hudson<sup>349</sup>, as shown in family tree 74.
345. AXIE KENNADAY (James's daughter) was born to James Kennaday<sup>348</sup> and Sarah Hudson<sup>349</sup>, as shown in family tree 74.
346. ALICE KENNADAY (James's daughter) was born to James Kennaday<sup>348</sup> and Sarah Hudson<sup>349</sup>, as shown in family tree 74.
347. JOSEPH WRIGHT KENNADAY (James's son) was born to James Kennaday<sup>348</sup> and Sarah Hudson<sup>349</sup>, as shown in family tree 74.

#### **Generation of Peers**

348. JAMES KENNADAY (The subject of this report) was born in Dublin, Ireland. James died on 5 May 1855.
349. SARAH HUDSON (James's wife).

James Kennaday<sup>348</sup> married Sarah Hudson. They had eight children:

- Joseph Bryson Kennaday<sup>339</sup> in 1823
- John Hudson Kennaday<sup>340</sup> in 1825
- Zarilda Kennaday<sup>342</sup> in 1828
- Mary Vicker Kennaday<sup>343</sup> in 1834
- Rachel A Kennaday<sup>344</sup>
- Axie Kennaday<sup>345</sup>
- Alice Kennaday<sup>346</sup>
- Joseph Wright Kennaday<sup>347</sup>

*This family is shown as family tree 74.*

**5. INDIRECTLY RELATED via BETTY CAROL FITZPATRICK** <sup>155</sup>  
(James's Great-Great-Great-Grandson's wife)

**Same generation as James's Five-Times-Great-Grandchildren**

350. JAYDON UNKNOWN (Betty's great-nephew) was born to Brian Unknown<sup>359</sup> and Jamie Christene Abner<sup>358</sup>.

**Same generation as James's Four-Times-Great-Grandchildren**

351. TERRI LYN FITZPATRICK (Betty's niece) was born to William Terry Fitzpatrick<sup>362</sup> and Linda D Shaw<sup>363</sup>.

352. TAMMY LYNN FITZPATRICK (Betty's niece) was born to William Terry Fitzpatrick<sup>362</sup> and Linda D Shaw<sup>363</sup>.

353. VIRGINIA RUTH FITZPATRICK (Betty's niece) was born to William Terry Fitzpatrick<sup>362</sup> and Linda D Shaw<sup>363</sup>.

354. A J FITZPATRICK (Betty's nephew) was born to William Terry Fitzpatrick<sup>362</sup> and Brenda Faye Mulberry<sup>364</sup>.

355. CANDICE MACHAEL WILLIAMS (Betty's niece) was born to Robert Therman Williams<sup>368</sup> and Tempie Ann Fitzpatrick<sup>366</sup>.

356. CASEY BRANDENBURG (Betty's niece's husband).

Casey Brandenburg married Candice Machael Williams<sup>355</sup>.

357. RONALD LEE ABNER, JR. (Betty's nephew) was born to Ronald Lee Abner<sup>369</sup> and Tempie Ann Fitzpatrick<sup>366</sup>.

358. JAMIE CHRISTENE ABNER (Betty's niece) was born to Ronald Lee Abner<sup>369</sup> and Tempie Ann Fitzpatrick<sup>366</sup>.

359. BRIAN UNKNOWN (Betty's niece's husband).

Brian Unknown married Jamie Christene Abner<sup>358</sup>. They had one son:  
Jaydon Unknown<sup>350</sup>

360. CHARLES RAYMOND THOMPSON, JR. (Betty's nephew) was born to Charles Raymond Thompson<sup>371</sup> and Sandra Darlene Fitzpatrick<sup>370</sup>.

361. DONNA DENICE THOMPSON (Betty's niece) was born on 6 January 1964 in Huntsville, Alabama, USA to Charles Raymond Thompson<sup>371</sup> and Sandra Darlene Fitzpatrick<sup>370</sup>. Donna died on 18 February 1964 as an infant, in Huntsville, Alabama, USA.

**Same generation as James's Great-Great-Great-Grandchildren**

362. WILLIAM TERRY FITZPATRICK (Betty's brother) was born to Edward S (Pete) Fitzpatrick<sup>372</sup> and Virginia Ruth Gulett<sup>374</sup>.

(William married three times. He was married to Linda D Shaw<sup>363</sup>, Brenda Faye Mulberry<sup>364</sup> and Karen Unknown<sup>365</sup>.)

363. LINDA D SHAW (Betty's sister-in-law).

William Terry Fitzpatrick<sup>362</sup> married Linda D Shaw. They had three children:

Terri Lyn Fitzpatrick<sup>351</sup>

Tammy Lynn Fitzpatrick<sup>352</sup>

Virginia Ruth Fitzpatrick<sup>353</sup>

364. BRENDA FAYE MULBERRY (Betty's sister-in-law).

William Terry Fitzpatrick<sup>362</sup> married Brenda Faye Mulberry. They had one son:

A J Fitzpatrick<sup>354</sup>

365. KAREN UNKNOWN (Betty's sister-in-law).

William Terry Fitzpatrick<sup>362</sup> married Karen Unknown.

366. TEMPIE ANN FITZPATRICK (Betty's sister) was born to Edward S (Pete) Fitzpatrick<sup>372</sup> and Virginia Ruth Gulett<sup>374</sup>.

(Tempie married three times. She was married to Johnny Glipsey<sup>367</sup>, Robert Therman Williams<sup>368</sup> and Ronald Lee Abner<sup>369</sup>.)

367. JOHNNY GLIPSEY (Betty's brother-in-law).

Johnny Glipsey married Tempie Ann Fitzpatrick<sup>366</sup>.

368. ROBERT THERMAN WILLIAMS (Betty's brother-in-law). Robert died in 1990.

Robert Therman Williams married Tempie Ann Fitzpatrick<sup>366</sup> on 27 November 1965. They had one daughter:

Candice Machael Williams<sup>355</sup>

369. RONALD LEE ABNER (Betty's brother-in-law).

Ronald Lee Abner married Tempie Ann Fitzpatrick<sup>366</sup> on 4 July 1972. They had two children:

Ronald Lee Abner, Jr.<sup>357</sup>  
 Jamie Christene Abner<sup>358</sup>

370. SANDRA DARLENE FITZPATRICK (Betty's sister) was born to Edward S (Pete) Fitzpatrick<sup>372</sup> and Virginia Ruth Gulett<sup>374</sup>.

371. CHARLES RAYMOND THOMPSON (Betty's brother-in-law).

Charles Raymond Thompson married Sandra Darlene Fitzpatrick<sup>370</sup> in November 1963. They had two children:  
 Charles Raymond Thompson, Jr.<sup>360</sup>  
 Donna Denice Thompson<sup>361</sup> in 1964

#### Same generation as James's Great-Great-Grandchildren

372. EDWARD S (PETE) FITZPATRICK (Betty's father) was born on 8 July 1916 in Bourbon, Kentucky, USA to William Allen Fitzpatrick<sup>375</sup> and Betty Jack Osburn<sup>376</sup>. Edward died on 8 November 1978, aged 62, in Bourbon, Kentucky, USA.

373. CECIL RAY MONTGOMERY (Betty's mother's husband).

Cecil married his indirect relation, Virginia Ruth Gulett<sup>374</sup>.

374. VIRGINIA RUTH GULETT (Betty's mother) was born on 23 February 1923 in Richmond, Kentucky, USA to Millard Gulett<sup>377</sup> and Cora Elizabeth Hutchchison<sup>378</sup>. Virginia died on 21 January 2007, aged 83, in Holiday, Pasco, Florida, USA.

(Virginia married twice. She was married to Edward S (Pete) Fitzpatrick<sup>372</sup> and Cecil Ray Montgomery<sup>373</sup>.)

Edward S (Pete) Fitzpatrick<sup>372</sup> married Virginia Ruth Gulett. They had four children:

Betty Carol Fitzpatrick<sup>155</sup> in 1947

William Terry Fitzpatrick<sup>362</sup>

Tempie Ann Fitzpatrick<sup>366</sup>

Sandra Darlene Fitzpatrick<sup>370</sup>

Cecil Ray Montgomery<sup>373</sup> married Virginia Ruth Gulett, aged 43, on 3 February 1967.

#### Same generation as James's Great-Grandchildren

375. WILLIAM ALLEN FITZPATRICK (Betty's grandfather) was born on 3 February 1887. William died on 12 March 1965, aged 78, in Northmiddle Town, Kentucky, USA.

376. BETTY JACK OSBURN (Betty's grandmother). Betty died in April 1961 in Northmiddle Town, Kentucky, USA.

William Allen Fitzpatrick<sup>375</sup> married Betty Jack Osburn. They had one son:

Edward S (Pete) Fitzpatrick<sup>372</sup> in 1916

377. MILLARD GULETT (Betty's grandfather) was born on 11 August 1883 in Bretthett, Kentucky to John W Gulett<sup>379</sup> and Cynthia Sizmoore<sup>380</sup>. Millard died on 8 March 1960, aged 76, in Harrisburg, Mercer, Kentucky, USA.

378. CORA ELIZABETH HUTCHCHISON (Betty's grandmother) was born on 29 September 1888 to Andy Hutchchison<sup>381</sup> and Lana Thomas<sup>382</sup>.

Millard Gulett<sup>377</sup> married Cora Elizabeth Hutchchison. They had one daughter:

Virginia Ruth Gulett<sup>374</sup> in 1923

#### Same generation as James's Grandchildren

379. JOHN W GULETT (Betty's great-grandfather).

380. CYNTHIA SIZMOORE (Betty's great-grandmother).

John W Gulett<sup>379</sup> married Cynthia Sizmoore. They had one son:

Millard Gulett<sup>377</sup> in 1883

381. ANDY HUTCHCHISON (Betty's great-grandfather).

382. LANA THOMAS (Betty's great-grandmother).

Andy Hutchchison<sup>381</sup> married Lana Thomas. They had one daughter:

Cora Elizabeth Hutchchison<sup>378</sup> in 1888

**6. INDIRECTLY RELATED via JOHN DAVID KELLEY** <sup>262</sup>  
(James's Great-Great-Granddaughter's husband)

**Same generation as James's Four-Times-Great-Grandchildren**

383. GARY SCOTT (John's great-nephew) was born on 3 January 1951 to Pete Scott<sup>408</sup> and Dorthy Mae Kelley<sup>407</sup>.
384. DONNA SCOTT (John's great-niece) was born on 4 August 1959 to Pete Scott<sup>408</sup> and Dorthy Mae Kelley<sup>407</sup>.
385. BOBBY GENE KELLEY (John's great-nephew) was born on 8 August 1954 in Carlisle, Kentucky, USA to Eugene Kelley<sup>409</sup> and Opal Unknown<sup>410</sup>.
386. CHARLES UNKNOWN (John's great-nephew) was born to Mr. Myers<sup>413</sup> and Juanita Kelley<sup>411</sup>.
387. CLARENCE UNKNOWN (John's great-nephew) was born to Mr. Myers<sup>413</sup> and Juanita Kelley<sup>411</sup>.
388. ELIZABETH FAYE UNKNOWN (John's great-niece) was born to Mr. Myers<sup>413</sup> and Juanita Kelley<sup>411</sup>.
389. HAROLED LEE PRUITT, JR. (John's great-nephew) was born to Harold Lee Pruitt<sup>415</sup> and Mary Elizabeth Kelley<sup>414</sup>.
390. DANNY JAMES PRUITT (John's great-nephew) was born to Harold Lee Pruitt<sup>415</sup> and Mary Elizabeth Kelley<sup>414</sup>.
391. RUTH ANN PRUITT (John's great-nephew) was born to Harold Lee Pruitt<sup>415</sup> and Mary Elizabeth Kelley<sup>414</sup>.
392. CRISTINE MAE PRUITT (John's great-niece) was born to Harold Lee Pruitt<sup>415</sup> and Mary Elizabeth Kelley<sup>414</sup>.
393. MICHAEL CAMERON PRUITT (John's great-nephew) was born to Harold Lee Pruitt<sup>415</sup> and Mary Elizabeth Kelley<sup>414</sup>.
394. ALLEN TODD PRUITT (John's great-nephew) was born to Harold Lee Pruitt<sup>415</sup> and Mary Elizabeth Kelley<sup>414</sup>.
395. ROSA E MARY BERRYMAN (John's great-niece) was born on 26 September 1959 to Tommy Berryman<sup>417</sup> and Wanda Lou Kelley<sup>416</sup>.
396. GILBART BERRYMAN (John's great-nephew) was born on 20 April 1961 to Tommy Berryman<sup>417</sup> and Wanda Lou Kelley<sup>416</sup>.
397. JULIE MAE BERRYMAN (John's great-niece) was born on 2 June 1962 to Tommy Berryman<sup>417</sup> and Wanda Lou Kelley<sup>416</sup>. Julie died on 3 September 1963, aged 1.
398. FREDA JEAN BERRYMAN (John's great-niece) was born on 14 September 1963 to Tommy Berryman<sup>417</sup> and Wanda Lou Kelley<sup>416</sup>.
399. TOMMY BERRYMAN, II (John's great-nephew) was born on 3 September 1964 to Tommy Berryman<sup>417</sup> and Wanda Lou Kelley<sup>416</sup>.
400. BONNIE SUE UNKNOWN (John's great-niece) was born to Mr. Cox<sup>420</sup> and Cristine Faye Kelley<sup>418</sup>.
401. BILLY JOE UNKNOWN (John's great-nephew) was born to Mr. Cox<sup>420</sup> and Cristine Faye Kelley<sup>418</sup>.
402. JIMMY UNKNOWN (John's great-nephew) was born to Mr. Cox<sup>420</sup> and Cristine Faye Kelley<sup>418</sup>.
403. CHIP UNKNOWN (John's great-nephew) was born to Brenda Jane Kelley<sup>421</sup>.
404. KIM UNKNOWN (John's great-niece) was born to Brenda Jane Kelley<sup>421</sup>.
405. AMANDA KELLEY (John's great-niece) was born to Billy Dean Kelley<sup>425</sup> and Ms. Unknown<sup>426</sup>.
406. BILLY DEAN KELLEY (John's great-nephew) was born to Billy Dean Kelley<sup>425</sup> and Ms. Unknown<sup>426</sup>.

**Same generation as James's Great-Great-Grandchildren**

407. DORTHY MAE KELLEY (John's niece) was born on 3 December 1932 in Carlisle, Kentucky, USA to James Luther Kelley<sup>432</sup> and Cristine Sapp<sup>433</sup>.
408. PETE SCOTT (John's niece's husband).  
Pete Scott married Dorothy Mae Kelley<sup>407</sup>. They had two children:  
Gary Scott<sup>383</sup> in 1951  
Donna Scott<sup>384</sup> in 1959
409. EUGENE KELLEY (John's nephew) was born on 25 April 1935 in Carlisle, Kentucky, USA to James Luther Kelley<sup>432</sup> and Cristine Sapp<sup>433</sup>.
410. OPAL UNKNOWN (John's nephew's wife).  
Eugene Kelley<sup>409</sup> married Opal Unknown. They had one son:  
Bobby Gene Kelley<sup>385</sup> in 1954
411. JUANITA KELLEY (John's niece) was born on 15 March 1937 in Carlisle, Kentucky, USA to James Luther Kelley<sup>432</sup> and Cristine Sapp<sup>433</sup>.  
(Juanita married twice. She was married to Mr. Walton<sup>412</sup> and Mr. Myers<sup>413</sup>.)
412. MR. WALTON (John's niece's husband).  
Mr. Walton married Juanita Kelley<sup>411</sup>.
413. MR. MYERS (John's niece's husband).  
Mr. Myers married Juanita Kelley<sup>411</sup>. They had three children:  
Charles Unknown<sup>386</sup>  
Clarence Unknown<sup>387</sup>  
Elizabeth Faye Unknown<sup>388</sup>
414. MARY ELIZABETH KELLEY (John's niece) was born on 2 January 1939 in Carlisle, Kentucky, USA to James Luther Kelley<sup>432</sup> and Cristine Sapp<sup>433</sup>.
415. HAROLD LEE PRUITT (John's niece's husband).  
Harold Lee Pruitt married Mary Elizabeth Kelley<sup>414</sup>. They had six children:  
Harold Lee Pruitt, Jr.<sup>389</sup>  
Danny James Pruitt<sup>390</sup>  
Ruth Ann Pruitt<sup>391</sup>  
Cristine Mae Pruitt<sup>392</sup>  
Michael Cameron Pruitt<sup>393</sup>  
Allen Todd Pruitt<sup>394</sup>
416. WANDA LOU KELLEY (John's niece) was born on 22 February 1942 in Carlisle, Kentucky, USA to James Luther Kelley<sup>432</sup> and Cristine Sapp<sup>433</sup>.
417. TOMMY BERRYMAN (John's niece's husband).  
Tommy Berryman married Wanda Lou Kelley<sup>416</sup>. They had five children:  
Rosa e Mary Berryman<sup>395</sup> in 1959  
Gilbart Berryman<sup>396</sup> in 1961  
Julie Mae Berryman<sup>397</sup> in 1962  
Freda Jean Berryman<sup>398</sup> in 1963  
Tommy Berryman, II<sup>399</sup> in 1964
418. CRISTINE FAYE KELLEY (John's niece) was born on 9 December 1945 in Carlisle, Kentucky, USA to James Luther Kelley<sup>432</sup> and Cristine Sapp<sup>433</sup>.  
(Cristine married twice. She was married to Mr. Treadway<sup>419</sup> and Mr. Cox<sup>420</sup>.)
419. MR. TREADWAY (John's niece's husband).  
Mr. Treadway married Cristine Faye Kelley<sup>418</sup>.
420. MR. COX (John's niece's husband).  
Mr. Cox married Cristine Faye Kelley<sup>418</sup>. They had three children:  
Bonnie Sue Unknown<sup>400</sup>  
Billy Joe Unknown<sup>401</sup>  
Jimmy Unknown<sup>402</sup>
421. BRENDA JANE KELLEY (John's niece) was born on 25 August 1951 in Carlisle, Kentucky, USA to James Luther Kelley<sup>432</sup> and Cristine Sapp<sup>433</sup>.  
Brenda had two children:  
Chip Unknown<sup>403</sup>  
Kim Unknown<sup>404</sup>

422. JAMES LUTHER KELLEY, JR. (John's nephew) was born on 14 February 1953 in Carlisle, Kentucky, USA to James Luther Kelley<sup>432</sup> and Cristine Sapp<sup>433</sup>.
423. FREDDIE WARREN KELLEY (John's nephew) was born on 24 September 1954 in Carlisle, Kentucky, USA to James Luther Kelley<sup>432</sup> and Cristine Sapp<sup>433</sup>. Freddie died on 4 November 1956, aged 2, of Drowend, in Carlisle, Kentucky, USA.
424. DONNIE LEE KELLEY (John's nephew) was born on 25 November 1955 in Carlisle, Kentucky, USA to James Luther Kelley<sup>432</sup> and Cristine Sapp<sup>433</sup>.
425. BILLY DEAN KELLEY (John's nephew) was born on 9 June 1958 in Carlisle, Kentucky, USA to James Luther Kelley<sup>432</sup> and Cristine Sapp<sup>433</sup>.
426. MS. UNKNOWN (John's nephew's wife).  
     Billy Dean Kelley<sup>425</sup> married Ms. Unknown. They had two children:  
         Amanda Kelley<sup>405</sup>  
         Billy Dean Kelley<sup>406</sup>
427. WILLIAM BLAINE KELLEY (John's nephew) was born to Talmadge Blane Kelley, Jr.<sup>434</sup> and Betty Earlywine<sup>435</sup>.
428. MILDRED ANN KELLEY (John's niece) was born to Talmadge Blane Kelley, Jr.<sup>434</sup> and Betty Earlywine<sup>435</sup>.
429. AQUILLA DAVID KELLEY (John's nephew) was born to Talmadge Blane Kelley, Jr.<sup>434</sup> and Betty Earlywine<sup>435</sup>.
430. MARY LOU KELLEY (John's niece) was born to Talmadge Blane Kelley, Jr.<sup>434</sup> and Betty Earlywine<sup>435</sup>.
431. BEVERLY KELLEY (John's niece) was born to Talmadge Blane Kelley, Jr.<sup>434</sup> and Betty Earlywine<sup>435</sup>.

**Same generation as James's Great-Great-Grandchildren**

432. JAMES LUTHER KELLEY (John's brother) was born on 31 March 1911 to Talmadge Blane Kelley<sup>442</sup> and Mary Elizabeth Minton<sup>443</sup>. James died on 27 March 1956, aged 44, in Carlisle, Kentucky, USA.
433. CRISTINE SAPP (John's sister-in-law) was born on 15 February 1919 to John Harvey Sapp<sup>596</sup> and Mary Miranda Unknown<sup>597</sup>.  
 [See also: *Indirectly related via Cristine Sapp*]  
     James Luther Kelley<sup>432</sup>, aged 21, married Cristine Sapp, aged 13, on 10 June 1932. They had eleven children:  
         Dorothy Mae Kelley<sup>407</sup> in 1932  
         Eugene Kelley<sup>409</sup> in 1935  
         Juanita Kelley<sup>411</sup> in 1937  
         Mary Elizabeth Kelley<sup>414</sup> in 1939  
         Wanda Lou Kelley<sup>416</sup> in 1942  
         Cristine Faye Kelley<sup>418</sup> in 1945  
         Brenda Jane Kelley<sup>421</sup> in 1951  
         James Luther Kelley, Jr.<sup>422</sup> in 1953  
         Freddie Warren Kelley<sup>423</sup> in 1954  
         Donnie Lee Kelley<sup>424</sup> in 1955  
         Billy Dean Kelley<sup>425</sup> in 1958
434. TALMADGE BLANE KELLEY, JR. (John's brother) was born on 28 January 1917 to Talmadge Blane Kelley<sup>442</sup> and Mary Elizabeth Minton<sup>443</sup>.
435. BETTY EARLYWINE (John's sister-in-law) was born to Lou Kelley<sup>598</sup>.  
 [See also: *Indirectly related via Betty Earlywine*]  
     Talmadge Blane Kelley, Jr.<sup>434</sup> married Betty Earlywine. They had five children:  
         William Blaine Kelley<sup>427</sup>  
         Mildred Ann Kelley<sup>428</sup>  
         Aquilla David Kelley<sup>429</sup>  
         Mary Lou Kelley<sup>430</sup>  
         Beverly Kelley<sup>431</sup>
436. AQUILLA DURHAM KELLEY (John's brother) was born to Talmadge Blane Kelley<sup>442</sup> and Mary Elizabeth Minton<sup>443</sup>.
437. EFRFIE MAE WATKINS (John's cousin) was born to Mr. Watkins<sup>448</sup> and Mabel Kelley<sup>447</sup>.

438. RAYMOND SADLER (John's cousin) was born to Mr. Sadler<sup>458</sup> and Carrie Minton<sup>457</sup>.
439. JAMES UNKNOWN (John's cousin) was born to Mr. Unknown<sup>461</sup> and Phillys Minton<sup>460</sup>.
440. EUGENE UNKNOWN (John's cousin) was born to Mr. Unknown<sup>461</sup> and Phillys Minton<sup>460</sup>.
441. BILL TOM UNKNOWN (John's cousin) was born to Mr. Unknown<sup>461</sup> and Phillys Minton<sup>460</sup>.

**Same generation as James's Great-Grandchildren**

442. TALMADGE BLANE KELLEY (John's father) was born on 12 July 1886 in Vandervill, Kentucky to Lewis Lute Kelley<sup>464</sup> and Amelia Frances Bowles<sup>465</sup>. Talmadge died on 6 February 1931, aged 44.  
 Note: *Tamalge & wife Mary moved in with Lewis on Mt. Merior Ridge and took care of him for a short time. (Between 1909-1911) Lewis then went from house to house, lived with his children.*
443. MARY ELIZABETH MINTON (John's mother) was born on 26 August 1876 in Old Virginia, Virginia to James M Minton<sup>466</sup> and Margaret Johnson<sup>467</sup>. Mary died on 26 January 1961, aged 84, in Carlisle, Kentucky, USA.  
 Talmadge Blane Kelley<sup>442</sup>, aged 23, married Mary Elizabeth Minton, aged 33, on 16 December 1909. They had four children:  
     James Luther Kelley<sup>432</sup> in 1911  
     Talmadge Blane Kelley, Jr.<sup>434</sup> in 1917  
     John David Kelley<sup>262</sup> in 1917  
     Aquilla Durham Kelley<sup>436</sup>
444. MILTON VARSO KELLEY (John's uncle) was born to Lewis Lute Kelley<sup>464</sup> and Amelia Frances Bowles<sup>465</sup>.
445. HERBERT KELLEY (John's uncle) was born to Lewis Lute Kelley<sup>464</sup> and Amelia Frances Bowles<sup>465</sup>.
446. HERMAN KELLEY (John's uncle) was born to Lewis Lute Kelley<sup>464</sup> and Amelia Frances Bowles<sup>465</sup>.
447. MABEL KELLEY (John's aunt) was born to Lewis Lute Kelley<sup>464</sup> and Amelia Frances Bowles<sup>465</sup>.
448. MR. WATKINS (John's uncle by marriage).  
 Mr. Watkins married Mabel Kelley<sup>447</sup>. They had one daughter:  
     Efrfie Mae Watkins<sup>437</sup>
449. BETTY JANE KELLEY (John's aunt) was born to Lewis Lute Kelley<sup>464</sup> and Amelia Frances Bowles<sup>465</sup>.
450. SILVERINE KELLEY (John's aunt) was born to Lewis Lute Kelley<sup>464</sup> and Amelia Frances Bowles<sup>465</sup>.
451. TONM MC RUTHER (John's uncle by marriage).  
 Tonm Mc Ruther married Silverine Kelley<sup>450</sup>.
452. DELLA MINTON (John's aunt) was born on 26 February 1876 to James M Minton<sup>466</sup> and Margaret Johnson<sup>467</sup>.
453. ISABELL MAY MINTON (John's aunt) was born on 15 May 1880 to James M Minton<sup>466</sup> and Margaret Johnson<sup>467</sup>.
454. IDA CATHERINE MINTON (John's aunt) was born on 9 May 1882 to James M Minton<sup>466</sup> and Margaret Johnson<sup>467</sup>.
455. JAMES MINTON (John's uncle) was born on 7 August 1884 to James M Minton<sup>466</sup> and Margaret Johnson<sup>467</sup>.
456. MAGGIE MINTON (John's aunt) was born on 13 April 1886 to James M Minton<sup>466</sup> and Margaret Johnson<sup>467</sup>.
457. CARRIE MINTON (John's aunt) was born on 7 June 1888 to James M Minton<sup>466</sup> and Margaret Johnson<sup>467</sup>.
458. MR. SADLER (John's uncle by marriage).  
 Mr. Sadler married Carrie Minton<sup>457</sup>. They had one son:  
     Raymond Sadler<sup>438</sup>
459. ROSAYELLA MINTON (John's aunt) was born on 7 October 1890 to James M Minton<sup>466</sup> and Margaret Johnson<sup>467</sup>.
460. PHILLYS MINTON (John's aunt) was born on 8 October 1892 to James M Minton<sup>466</sup> and Margaret Johnson<sup>467</sup>.
461. MR. UNKNOWN (John's uncle by marriage).



Mr. Unknown married Phyllis Minton<sup>460</sup>. They had three children:  
 James Unknown<sup>439</sup>  
 Eugene Unknown<sup>440</sup>  
 Bill Tom Unknown<sup>441</sup>

462. WALTER MINTON (John's uncle) was born on 12 August 1894 to James M Minton<sup>466</sup> and Margaret Johnson<sup>467</sup>.  
 Note: *Lived in Cynthiana, Kentucky had two daughters.*

463. ETHEL MINTON (John's aunt) was born on 1 June 1896 to James M Minton<sup>466</sup> and Margaret Johnson<sup>467</sup>.

#### Same generation as James's Grandchildren

464. LEWIS LUTE KELLEY (John's grandfather) was born on 5 February 1863 in Nichlos, County, Kentucky to William S Kelley<sup>468</sup> and Elizabeth Smith<sup>469</sup>. Lewis died on 25 July 1932, aged 69, in Ad Richeys home in Myers station.  
 Note: *Lewis Kelley bought house on Mt Merior Ridge with insurance money from Son Herbert who was killed whe he fell from a telephone pole. and son Milton who was a world war vet who died in Dayton, Ohio Hospital neither son was ever married. Lewis walked with a cane. He had leg or legs broke in mill accident with logs. He never had his legs set by a doctor. Lewis's father left his mother (Elizabeth Smith) before Lewis was born never to be heard of again. Elizabeth later married amn named Sparks and had several childern. Lewis was raised with his half brothers and sisters.*

465. AMELIA FRANCES BOWLES (John's grandmother) was born on 20 June 1865.  
 Lewis Lute Kelley<sup>464</sup>, aged 21, married Amelia Frances Bowles, aged 19, on 14 October 1884. They had seven children:

Talmadge Blane Kelley<sup>442</sup> in 1886  
 Milton Varso Kelley<sup>444</sup>  
 Herbert Kelley<sup>445</sup>  
 Herman Kelley<sup>446</sup>  
 Mabel Kelley<sup>447</sup>  
 Betty Jane Kelley<sup>449</sup>  
 Silverine Kelley<sup>450</sup>

466. JAMES M MINTON (John's grandfather) was born on 3 April 1851. James died on 23 October 1917, aged 66.  
 Note: *James Minton and Margaret Johnson came from Russell Co. Virginia and were married in Tennessee. (information came from Ant Carrie Sadler taken out of her bible.*

467. MARGARET JOHNSON (John's grandmother) was born on 8 May 1856. Margaret died on 7 March 1938, aged 81.  
 James M Minton<sup>466</sup> married Margaret Johnson in Tennessee. They had eleven children:

Della Minton<sup>452</sup> in 1876  
 Mary Elizabeth Minton<sup>443</sup> in 1876  
 Isabell May Minton<sup>453</sup> in 1880  
 Ida Catherine Minton<sup>454</sup> in 1882  
 James Minton<sup>455</sup> in 1884  
 Maggie Minton<sup>456</sup> in 1886  
 Carrie Minton<sup>457</sup> in 1888  
 Rosayella Minton<sup>459</sup> in 1890  
 Phyllis Minton<sup>460</sup> in 1892  
 Walter Minton<sup>462</sup> in 1894  
 Ethel Minton<sup>463</sup> in 1896

#### Same generation as James's Children

468. WILLIAM S KELLEY (John's great-grandfather) was born to Erasmus E Kelley<sup>470</sup> and Mary Mc Iwoan<sup>471</sup>.

469. ELIZABETH SMITH (John's great-grandmother).

William S Kelley<sup>468</sup> married Elizabeth Smith on 21 May 1870. They had one son:  
 Lewis Lute Kelley<sup>464</sup> in 1863

**Same generation as James's Peers**

470. ERAMUS E KELLEY (John's great-great-grandfather) was born to Edward Kelley<sup>472</sup> and America Mull<sup>473</sup>.

471. MARY MC IWOAN (John's great-great-grandmother).

Eramus E Kelley<sup>470</sup> married Mary Mc Iwoan on 17 March 1856. They had one son:  
William S Kelley<sup>468</sup>

**Same generation as James's Parents**

472. EDWARD KELLEY (John's great-great-great-grandfather).

Note: *Edward's brother wrote until Dec. 26, 1822. Was probated October term court in 1823. He left everything to his wife Eleanor except \$1.00 to each of his children his will did not mane any children.*

473. AMERICA MULL (John's great-great-great-grandmother).

Edward Kelley<sup>472</sup> married America Mull on 16 February 1834. They had one son:  
Eramus E Kelley<sup>470</sup>

**7. INDIRECTLY RELATED via BRUCE DOUGLAS WHITMAN<sup>276</sup>**  
(James's Great-Great-Granddaughter's husband)

**Same generation as James's Great-Great-Great-Grandchildren**

474. MARCUS PINE WHITMAN (Bruce's son) was born in 1962 to Bruce Douglas Whitman<sup>276</sup> and Claudette Irene Corlett<sup>475</sup>.

**Same generation as James's Great-Great-Great-Grandchildren**

475. CLAUDETTE IRENE CORLETT (Bruce's wife).

Bruce Douglas Whitman<sup>276</sup> married Claudette Irene Corlett. They had one son:  
Marcus Pine Whitman<sup>474</sup> in 1962

476. LORRAINE MADDEN (Bruce's wife).

Bruce Douglas Whitman<sup>276</sup> married Lorraine Madden.

**8. INDIRECTLY RELATED via MABLE PIERCE**<sup>317</sup>  
(James's Great-Grandson's wife)

**Same generation as James's Great-Grandchildren**

477. ALICE PEARCE (Mable's sister) was born on 28 December 1893 in Denver, Colorado to Thomas Earl Pearce<sup>479</sup> and Mary Adele Lambs- Cobb<sup>481</sup>.

478. VIRGIE PHIPPS (Mable's half-sister) was born to James Phipps<sup>480</sup> and Mary Adele Lambs- Cobb<sup>481</sup>.

**Same generation as James's Grandchildren**

479. THOMAS EARL PEARCE (Mable's father) was born on 6 June 1858 in London, England. He became a Long Distance Runner.

*Note: Thomas came to the United States when he was 20 as a long distance runner and he returned to England only once than came back to the United States and settled in Denver, Colorado, where he met Mary. They Thomas was fourteen years older than Mary. When their two girls were young they moved to Saratoga, Wyoming and homesteaded a piece of ground outside of Saratoga toward the Rocky Mountains. Thomas had a brother named Walter and a sister named Elizabeth (Lizzie)*

*All notes were prepared by: Florence Kennaday.*

480. JAMES PHIPPS (Mable's mother's husband) was born in London, England.

James married his indirect relation, Mary Adele Lambs- Cobb<sup>481</sup>.

481. MARY ADELE LAMBS- COBB (Mable's mother) was born on 24 September 1872 in Macon, Missouri.

(Mary married twice. She was married to Thomas Earl Pearce<sup>479</sup> and James Phipps<sup>480</sup>.)

*Note: Not sure which of the two Madin names was her real name and which was the name of the people that raised her. Her Mother was one half Cherokee indian and her father was a white man. She got married while she was in Missouri and in 1888 she again got married to James Phipps. She had two girls, Virgie and I don't know the name of the other girl. When the girls were small Mary, her sister Alice and her husband started for Colorado. They traveled by covered wagon and on the way the younger daughter was bitten by a tarantula and died. Mary and her sister Alice had to leave Missouri because a doctor had advised them to go to a higher and drier climate, as both of them had tuberculosis. Mary's sister finally died from the disease, but Mary lived into her 80's. Mary left Thomas and got custody of the girls, but when Thomas left Saratoga and stole the girls and moved back to Denver where he went to work and put them in an orphanage. I don't know when Mary finally got the girls back but they were eventually back together in Saratoga. While in Saratoga Mary had to earn a living so she became a Practical Nurse to support herself and her daughters.*

*All Notes were prepared by: Florence Kennaday.*

Thomas Earl Pearce<sup>479</sup> married Mary Adele Lambs- Cobb in Denver, Colorado. They had two children:

Alice Pearce<sup>477</sup> in 1893

Mable Pierce<sup>317</sup> in 1897

James Phipps<sup>480</sup> married Mary Adele Lambs- Cobb, aged about 15, in 1888. They had one daughter:

Virgie Phipps<sup>478</sup>

**9. INDIRECTLY RELATED via FRANCES ELIZABETH KENNEDY** <sup>330</sup>  
(James's Grandson's wife)

**Same generation as James's Great-Grandchildren**

482. MARCY KENNEDY (Frances's niece) was born to Alferd Shidler<sup>499</sup> and Mariah Kennedy<sup>498</sup>.
483. EDDIE KENNEDY (Frances's nephew) was born to Alferd Shidler<sup>499</sup> and Mariah Kennedy<sup>498</sup>.
484. ALVIN KENNEDY (Frances's nephew) was born to Alferd Shidler<sup>499</sup> and Mariah Kennedy<sup>498</sup>.
485. BEARTHEY KENNEDY (Frances's nephew) was born to Alferd Shidler<sup>499</sup> and Mariah Kennedy<sup>498</sup>.
486. WILLBER KENNEDY (Frances's nephew) was born to Alferd Shidler<sup>499</sup> and Mariah Kennedy<sup>498</sup>.
487. ADDIE KENNEDY (Frances's niece) was born to Alferd Shidler<sup>499</sup> and Mariah Kennedy<sup>498</sup>.
488. JESSE RUFUS KENNEDY (Frances's nephew) was born on 17 May 1885 in Ceder Vale, Chautauqua, Kansas, USA to John Ronnie Kennedy<sup>501</sup> and Nancy Alice Martindale<sup>502</sup>.
489. FAY MCCLURE (Frances's nephew's wife).  
Jesse Rufus Kennedy<sup>488</sup>, aged 24, married Fay McClure on 6 April 1910.
490. FREDRICK FAY KENNEDY (Frances's nephew) was born on 21 January 1888 in Ceder Vale, Chautauqua, Kansas, USA to John Ronnie Kennedy<sup>501</sup> and Nancy Alice Martindale<sup>502</sup>. Fredrick died on 29 November 1908, aged 20.
491. SADIE BELL KENNEDY (Frances's niece) was born on 2 January 1890 in Ceder Vale, Chautauqua, Kansas, USA to John Ronnie Kennedy<sup>501</sup> and Nancy Alice Martindale<sup>502</sup>. Sadie died on 5 December 1922, aged 32.
492. JAY MCCLURE (Frances's niece's husband).  
Jay McClure married Sadie Bell Kennedy<sup>491</sup>, aged 18, on 29 January 1908.
493. LILLIE IRENE KENNEDY (Frances's niece) was born on 4 May 1906 in Ceder Vale, Chautauqua, Kansas, USA to John Ronnie Kennedy<sup>501</sup> and Nancy Alice Martindale<sup>502</sup>.
494. ELMER PERRY (Frances's niece's husband).  
Elmer Perry married Lillie Irene Kennedy<sup>493</sup>.
495. CLARENCE BLAND KENNEDY (Frances's nephew) was born on 9 April 1880 in Ceder Vale, Chautauqua, Kansas, USA to John Ronnie Kennedy<sup>501</sup> and Nancy Alice Martindale<sup>502</sup>.
496. ALICE UNKNOWN (Frances's nephew's wife).  
Clarence Bland Kennedy<sup>495</sup> married Alice Unknown.

**Same generation as James's Grandchildren**

497. EMALINE KENNEDY (Frances's sister) was born on 25 October 1852 to Jesse Rufus Kennedy<sup>514</sup> and Sarah Ann Ankrom<sup>515</sup>. Emaline died on 27 February 1860, aged 7.
498. MARIAH KENNEDY (Frances's sister) was born on 13 March 1854 to Jesse Rufus Kennedy<sup>514</sup> and Sarah Ann Ankrom<sup>515</sup>. Mariah died on 14 November 1911, aged 57.
499. ALFERD SHIDLER (Frances's brother-in-law).  
Alferd Shidler married Mariah Kennedy<sup>498</sup>, aged 23, on 20 August 1877. They had six children:  
Marcy Kennedy<sup>482</sup>  
Eddie Kennedy<sup>483</sup>  
Alvin Kennedy<sup>484</sup>  
Bearthey Kennedy<sup>485</sup>  
Willber Kennedy<sup>486</sup>  
Addie Kennedy<sup>487</sup>
500. NANCH ISABELL KENNEDY (Frances's sister) was born on 25 December 1855 to Jesse Rufus Kennedy<sup>514</sup> and Sarah Ann Ankrom<sup>515</sup>. Nanch died in March 1860, aged 4.
501. JOHN RONNIE KENNEDY (Frances's brother) was born on 26 December 1857 in Vinton, Ohio, USA to Jesse Rufus Kennedy<sup>514</sup> and Sarah Ann Ankrom<sup>515</sup>. John died on 20 January 1926, aged 68.
502. NANCY ALICE MARTINDALE (Frances's sister-in-law) was born on 2 November 1864. Nancy died on 27 August 1952, aged 87, in Polk, Missouri, USA.  
John Ronnie Kennedy<sup>501</sup>, aged 24, married Nancy Alice Martindale, aged 17, on 6 September 1882. They had five children:

Jesse Rufus Kennedy<sup>488</sup> in 1885  
 Fredrick Fay Kennedy<sup>490</sup> in 1888  
 Sadie Bell Kennedy<sup>491</sup> in 1890  
 Lillie Irene Kennedy<sup>493</sup> in 1906  
 Clarence Bland Kennedy<sup>495</sup> in 1980

503. ANDREW KENNEDY (Frances's brother) was born on 20 August 1860 in Vinton, Ohio, USA to Jesse Rufus Kennedy<sup>514</sup> and Sarah Ann Ankrom<sup>515</sup>. Andrew died on 12 September 1929, aged 69.
504. EFFIE BACUS (Frances's sister-in-law).  
 Andrew Kennedy<sup>503</sup>, aged 21, married Effie Bacus on 9 May 1882.
505. SAMUEL RUFUS KENNEDY (Frances's brother) was born on 24 October 1862 to Jesse Rufus Kennedy<sup>514</sup> and Sarah Ann Ankrom<sup>515</sup>. Samuel died on 29 January 1896, aged 33.
506. LILLIE TREDWAY (Frances's sister-in-law).  
 Samuel Rufus Kennedy<sup>505</sup>, aged 23, married Lillie Tredway on 8 July 1886.
507. JAMES FRANKLIN KENNEDY (Frances's brother) was born on 15 November 1866 in Boody, Macon, Illinois to Jesse Rufus Kennedy<sup>514</sup> and Sarah Ann Ankrom<sup>515</sup>. James died on 21 January 1918, aged 51.
508. LOUISE WHITED (Frances's sister-in-law).  
 James Franklin Kennedy<sup>507</sup>, aged 32, married Louise Whited on 11 March 1899.
509. WILLIAM EDSON KENNEDY (Frances's brother) was born on 15 October 1868 in Boody, Macon, Illinois to Jesse Rufus Kennedy<sup>514</sup> and Sarah Ann Ankrom<sup>515</sup>. William died on 12 March 1889, aged 20.
510. GEORGE WASHINGTON KENNEDY (Frances's brother) was born on 11 October 1870 in Ceder Vale, Chautauqua, Kansas, USA to Jesse Rufus Kennedy<sup>514</sup> and Sarah Ann Ankrom<sup>515</sup>. George died on 30 March 1931, aged 60.
511. MARY ELIZABETH SKELTON (Frances's sister-in-law) was born on 14 August 1863 in Seligman, Barry, Missouri, USA to James Franklin Skelton<sup>589</sup> and Mary Jane Unknown<sup>590</sup>.  
*[See also: Indirectly related via Mary Elizabeth Skelton]*  
 George Washington Kennedy<sup>510</sup>, aged 18, married Mary Elizabeth Skelton, aged 25, on 7 April 1889 in Missouri, USA.
512. SARAH JANE KENNEDY (Frances's sister) was born on 11 December 1872 in Ceder Vale, Chautauqua, Kansas, USA to Jesse Rufus Kennedy<sup>514</sup> and Sarah Ann Ankrom<sup>515</sup>. Sarah died on 20 March 1880, aged 7.
513. JESSE WIRTZ (Frances's sister) was born to Jesse Rufus Kennedy<sup>514</sup> and Sarah Ann Ankrom<sup>515</sup>.  
 Note: *Jesse was raised from infant. And was daughter of Kennaday and Ida Jane Wirts.*

#### Same generation as James's Children

514. JESSE RUFUS KENNEDY (Frances's father) was born on 2 March 1831 in Gurnsey, Ohio, USA to John Kennedy<sup>540</sup> and Sarah Jane Raynor<sup>541</sup>. He became a Pioneer Farmer. Jesse died on 7 August 1899, aged 68, in Ceder Vale, Chautauqua, Kansas, USA.
515. SARAH ANN ANKROM (Frances's mother) was born on 12 September 1830 in Green, Pennsylvania, USA to John Ankrom<sup>542</sup> and Ruth Unknown<sup>543</sup>. Sarah died on 29 March 1920, aged 89, in Ceder Vale, Chautauqua, Kansas, USA.  
 Jesse Rufus Kennedy<sup>514</sup>, aged 20, married Sarah Ann Ankrom, aged 21, on 11 December 1851 in Ohio. They had twelve children:  
 Emaline Kennedy<sup>497</sup> in 1852  
 Mariah Kennedy<sup>498</sup> in 1854  
 Nanch Isabell Kennedy<sup>500</sup> in 1855  
 John Ronnie Kennedy<sup>501</sup> in 1857  
 Andrew Kennedy<sup>503</sup> in 1860  
 Samuel Rufus Kennedy<sup>505</sup> in 1862  
 Frances Elizabeth Kennedy<sup>330</sup> in 1864  
 James Franklin Kennedy<sup>507</sup> in 1866  
 William Edson Kennedy<sup>509</sup> in 1868  
 George Washington Kennedy<sup>510</sup> in 1870  
 Sarah Jane Kennedy<sup>512</sup> in 1872  
 Jesse Wirtz<sup>513</sup>
516. NANCY KENNEDY (Frances's aunt) was born on 1 January 1821 in Wanesburg, Green, Pennsylvania, USA to John Kennedy<sup>540</sup> and Sarah Jane Raynor<sup>541</sup>. Nancy died in 1901, aged about 80.

517. BENJAMIN KIRK SHEPHERD (Frances's uncle by marriage).  
Benjamin Kirk Shepherd married Nancy Kennedy<sup>516</sup>, aged 21, on 29 December 1842.
518. CHRISTINE KENNEDY (Frances's aunt) was born on 11 July 1822 in Wanesburg, Green, Pennsylvania, USA to John Kennedy<sup>540</sup> and Sarah Jane Raynor<sup>541</sup>.
519. JACOB KENNEDY (Frances's uncle) was born on 10 November 1826 in Wanyesburg, Green, Pennsylvania USA to John Kennedy<sup>540</sup> and Sarah Jane Raynor<sup>541</sup>.
520. JAMES LEIGHTON KENNEDY (Frances's uncle) was born on 10 November 1826 in Waynesburg, Green, Pennsylvania USA to John Kennedy<sup>540</sup> and Sarah Jane Raynor<sup>541</sup>. James died on 19 March 1875, aged 48.
521. ELIZABETH RHINEHEART (Frances's aunt by marriage). Elizabeth died on 19 March 1875.  
James Leighton Kennedy<sup>520</sup> married Elizabeth Rhineheart.
522. JONN KENNEDY (Frances's uncle) was born on 19 June 1833 in Vinton, Ohio, USA to John Kennedy<sup>540</sup> and Sarah Jane Raynor<sup>541</sup>.
523. LYDIA JARVIS (Frances's aunt by marriage).  
Jonn Kennedy<sup>522</sup>, aged 28, married Lydia Jarvis on 6 October 1861 in Nobel.
524. EMILINE KENNEDY (Frances's aunt) was born on 9 January 1836 in Noble, Ohio, USA to John Kennedy<sup>540</sup> and Sarah Jane Raynor<sup>541</sup>. Emiline died on 19 May 1923, aged 87.
525. SAMUEL KENNEDY (Frances's uncle) was born on 28 February 1837 in Zaleski, Vinton, Ohio, USA to John Kennedy<sup>540</sup> and Sarah Jane Raynor<sup>541</sup>.
526. SARAH JANE KENNEDY (Frances's aunt) was born on 16 June 1840 in Zaleski, Vinton, Ohio, USA to John Kennedy<sup>540</sup> and Sarah Jane Raynor<sup>541</sup>.
527. ELIZABETH KENNEDY (Frances's aunt) was born on 16 June 1842 to John Kennedy<sup>540</sup> and Sarah Jane Raynor<sup>541</sup>.
528. REBECCA KENNEDY (Frances's aunt) was born on 9 April 1845 in Vinton, Ohio, USA to John Kennedy<sup>540</sup> and Sarah Jane Raynor<sup>541</sup>. Rebecca died on 1 January 1882, aged 36.
529. RICHARD ANKROM (Frances's uncle) was born on 5 February 1827 in Green, Pennsylvania, USA to John Ankrom<sup>542</sup> and Ruth Unknown<sup>543</sup>.
530. SOLOMON ANKROM (Frances's uncle) was born on 8 August 1828 in Green, Pennsylvania, USA to John Ankrom<sup>542</sup> and Ruth Unknown<sup>543</sup>. Solomon died on 2 June 1850, aged 21.
531. JOHN ELLERY ANKROM (Frances's uncle) was born on 2 June 1833 in Green, Pennsylvania, USA to John Ankrom<sup>542</sup> and Ruth Unknown<sup>543</sup>. John died on 14 June 1850, aged 17.
532. MARY ANN ANKROM (Frances's aunt) was born on 14 July 1835 to John Ankrom<sup>542</sup> and Ruth Unknown<sup>543</sup>.
533. MARTHA ANN ANKROM (Frances's aunt) was born on 4 November 1837 in Green, Pennsylvania, USA to John Ankrom<sup>542</sup> and Ruth Unknown<sup>543</sup>. Martha died on 24 June 1855, aged 17.
534. WILLIAM ANKROM (Frances's uncle) was born on 7 April 1840 in Green, Pennsylvania, USA to John Ankrom<sup>542</sup> and Ruth Unknown<sup>543</sup>.
535. URIAH ANKROM (Frances's uncle) was born on 29 May 1842 in Green, Pennsylvania, USA to John Ankrom<sup>542</sup> and Ruth Unknown<sup>543</sup>. Uriah died on 3 March 1860, aged 17.
536. ELIZABETH ANKROM (Frances's aunt) was born on 27 June 1844 in Green, Pennsylvania, USA to John Ankrom<sup>542</sup> and Ruth Unknown<sup>543</sup>.
537. MIRIAH ANKROM (Frances's aunt) was born on 28 December 1846 in Green, Pennsylvania, USA to John Ankrom<sup>542</sup> and Ruth Unknown<sup>543</sup>.
538. CLEMENTINE ANKROM (Frances's aunt) was born on 21 November 1848 in Green, Pennsylvania, USA to John Ankrom<sup>542</sup> and Ruth Unknown<sup>543</sup>. Clementine died on 8 April 1866, aged 17.

539. THOMAS ANKROM (Frances's uncle) was born on 1 May 1853 in Green, Pennsylvania, USA to John Ankrom<sup>542</sup> and Ruth Unknown<sup>543</sup>.

#### Same generation as James's Peers

540. JOHN KENNEDY (Frances's grandfather) was born on 9 January 1795 in Dublin, Ireland to William Kennedy<sup>544</sup>. He became a Farmer, Soldier in war of 1812. John died on 10 August 1865, aged 70, in JacksoTownsh, Ohio, USA.

541. SARAH JANE RAYNOR (Frances's grandmother) was born on 10 October 1797 in Waynesburg, Green, Pennsylvania USA to Jake Raynor<sup>545</sup>. Sarah died on 8 April 1888, aged 90.

John Kennedy<sup>540</sup>, aged about 23, married Sarah Jane Raynor, aged about 20, in 1818. They had eleven children:

Nancy Kennedy<sup>516</sup> in 1821  
 Christine Kennedy<sup>518</sup> in 1822  
 Jacob Kennedy<sup>519</sup> in 1826  
 James Leighton Kennedy<sup>520</sup> in 1826  
 Jesse Rufus Kennedy<sup>514</sup> in 1831  
 Jonn Kennedy<sup>522</sup> in 1833  
 Emiline Kennedy<sup>524</sup> in 1836  
 Samuel Kennedy<sup>525</sup> in 1837  
 Sarah Jane Kennedy<sup>526</sup> in 1840  
 Elizabeth Kennedy<sup>527</sup> in 1842  
 Rebecca Kennedy<sup>528</sup> in 1845

542. JOHN ANKROM (Frances's grandfather) was born on 9 August 1809 in Green, Pennsylvania, USA to William Ankrom<sup>546</sup> and Mary Egor<sup>547</sup>. John died on 12 May 1887, aged 77.

543. RUTH UNKNOWN (Frances's grandmother) was born on 2 April 1807 to Joseph Ankrom<sup>548</sup> and Elizabeth Sellers<sup>549</sup>.

John Ankrom<sup>542</sup>, aged 16, married Ruth Unknown, aged 19, on 7 May 1826. They had twelve children:

Richard Ankrom<sup>529</sup> in 1827  
 Solomon Ankrom<sup>530</sup> in 1828  
 Sarah Ann Ankrom<sup>515</sup> in 1830  
 John Ellery Ankrom<sup>531</sup> in 1833  
 Mary Ann Ankrom<sup>532</sup> in 1835  
 Martha Ann Ankrom<sup>533</sup> in 1837  
 William Ankrom<sup>534</sup> in 1840  
 Uriah Ankrom<sup>535</sup> in 1842  
 Elizabeth Ankrom<sup>536</sup> in 1844  
 Miriah Ankrom<sup>537</sup> in 1846  
 Clementine Ankrom<sup>538</sup> in 1848  
 Thomas Ankrom<sup>539</sup> in 1853

#### Same generation as James's Parents

544. WILLIAM KENNEDY (Frances's great-grandfather).

William fathered one son:

John Kennedy<sup>540</sup> in 1795

545. JAKE RAYNOR (Frances's great-grandfather).

Jake fathered one daughter:

Sarah Jane Raynor<sup>541</sup> in 1797

546. WILLIAM ANKROM (Frances's great-grandfather).

547. MARY EAGOR (Frances's great-grandmother).

William Ankrom<sup>546</sup> married Mary Egor. They had one son:

John Ankrom<sup>542</sup> in 1809

548. JOSEPH ANKROM (Frances's great-grandfather).

549. ELIZABETH SELLERS (Frances's great-grandmother).

Joseph Ankrom<sup>548</sup> married Elizabeth Sellers. They had one daughter:

Ruth Unknown<sup>543</sup> in 1807



**10. INDIRECTLY RELATED via ANNE ELIZABETH VAN ORSDEL**<sup>341</sup>  
(James's Daughter-in-law)

**Same generation as James's Children**

550. JOHN WILLIAMS (Anne's husband).  
John Williams married Anne Elizabeth Van Orsdel<sup>341</sup>.
551. WILLIAM GEORGE VAN ORSDEL (Anne's brother) was born on 15 December 1827 in Harrisburg, Mercer, Kentucky, USA to Abram F Van Orsdel, Jr.<sup>570</sup> and Rebecca K Boice<sup>571</sup>. William died on 19 February 1863, aged 35.
552. SARAH CATTERSON (Anne's sister-in-law).  
William George Van Orsdel<sup>551</sup>, aged 23, married Sarah Catterson on 22 February 1851.
553. JAMES H VAN ORSDEL (Anne's brother) was born on 11 February 1830 in Knox, Indiana, USA to Abram F Van Orsdel, Jr.<sup>570</sup> and Rebecca K Boice<sup>571</sup>.
554. SALLIE MATOXX (Anne's sister-in-law).  
James H Van Orsdel<sup>553</sup>, aged 24, married Sallie Matoxx on 22 July 1854.
555. MARY B VAN ORSDEL (Anne's sister) was born on 21 June 1834 in Knox, Indiana, USA to Abram F Van Orsdel, Jr.<sup>570</sup> and Rebecca K Boice<sup>571</sup>. Mary died on 11 March 1914, aged 79.
556. REUBIN THORNHELL (Anne's brother-in-law).  
Reubin Thornhell married Mary B Van Orsdel<sup>555</sup>.
557. REBECCA ELLEN VAN ORSDEL (Anne's sister) was born on 24 February 1839 in Lexington, Fayette, Kentucky, USA to Abram F Van Orsdel, Jr.<sup>570</sup> and Rebecca K Boice<sup>571</sup>. Rebecca died on 18 January 1921, aged 81.
558. WILLIAM B HEWITT (Anne's brother-in-law).  
William B Hewitt married Rebecca Ellen Van Orsdel<sup>557</sup>, aged 20, on 13 February 1860.
559. MELINDA CATHERINE VAN ORSDEL (Anne's sister) was born on 14 October 1841 in Lexington, Fayette, Kentucky, USA to Abram F Van Orsdel, Jr.<sup>570</sup> and Rebecca K Boice<sup>571</sup>. Melinda died on 6 June 1934, aged 92.
560. JOHN BENJAMIN POLLARD (Anne's brother-in-law).  
John Benjamin Pollard married Melinda Catherine Van Orsdel<sup>559</sup>, aged 20, on 31 December 1861.
561. SARAH E VAN ORSDEL (Anne's sister) was born on 31 August 1843 in Cynthiana, Scott, Kentucky, USA to Abram F Van Orsdel, Jr.<sup>570</sup> and Rebecca K Boice<sup>571</sup>. Sarah died on 27 February 1895, aged 51.  
(Sarah married twice. She was married to Thomas Rogers<sup>562</sup> and Noah Diehl<sup>563</sup>.)
562. THOMAS ROGERS (Anne's brother-in-law).  
Thomas Rogers married Sarah E Van Orsdel<sup>561</sup>, aged 24, on 3 July 1868.
563. NOAH DIEHL (Anne's brother-in-law).  
Noah Diehl married Sarah E Van Orsdel<sup>561</sup>, aged 44, on 13 June 1888.
564. ABRAM VAN ORSDEL (Anne's brother) was born on 31 December 1845 in Bourbon, Kentucky, USA to Abram F Van Orsdel, Jr.<sup>570</sup> and Rebecca K Boice<sup>571</sup>. Abram died on 4 January 1846 as an infant.
565. ISABELL VAN ORSDEL (Anne's sister) was born on 1 December 1846 in Cynthiana, Scott, Kentucky, USA to Abram F Van Orsdel, Jr.<sup>570</sup> and Rebecca K Boice<sup>571</sup>. Isabell died on 24 March 1890, aged 43.
566. JAMES H WALLACE (Anne's brother-in-law).  
James H Wallace married Isabell Van Orsdel<sup>565</sup>, aged 20, on 25 December 1866.
567. HENERY GEORGE VAN ORSDEL (Anne's brother) was born on 17 June 1849 in Owen, Kentucky, USA to Abram F Van Orsdel, Jr.<sup>570</sup> and Rebecca K Boice<sup>571</sup>.  
(Henry married twice. He was married to Annie E Mitchell<sup>568</sup> and Mattie Anderson<sup>569</sup>.)
568. ANNIE E MITCHELL (Anne's sister-in-law).  
Henry George Van Orsdel<sup>567</sup>, aged about 17, married Annie E Mitchell in 1866.
569. MATTIE ANDERSON (Anne's sister-in-law).  
Henry George Van Orsdel<sup>567</sup>, aged about 28, married Mattie Anderson in 1877.

**Same generation as James's Peers**

570. ABRAM F VAN ORSDEL, JR. (Anne's father) was born in 1808 to Abram Van Orsdel Van Orsdel<sup>584</sup> and Ellen Unknown<sup>585</sup>. Abram died in 1849, aged about 41.
571. REBECCA K BOICE (Anne's mother) was born on 16 April 1810 in Harrisburg, Mercer, Kentucky, USA to Ephriam Boice<sup>586</sup> and Mary Vicker Smock<sup>587</sup>. Rebecca died on 6 April 1900, aged 89, in Clay, City Powel, Kentucky, USA. Abram F Van Orsdel, Jr.<sup>570</sup>, aged about 18, married Rebecca K Boice, aged 16, on 27 February 1827. They had ten children:
- William George Van Orsdel<sup>551</sup> in 1827
  - James H Van Orsdel<sup>553</sup> in 1830
  - Mary B Van Orsdel<sup>555</sup> in 1834
  - Anne Elizabeth Van Orsdel<sup>341</sup> in 1836
  - Rebecca Ellen Van Orsdel<sup>557</sup> in 1839
  - Melinda Catherine Van Orsdel<sup>559</sup> in 1841
  - Sarah E Van Orsdel<sup>561</sup> in 1843
  - Abram Van Orsdel<sup>564</sup> in 1845
  - Isabell Van Orsdel<sup>565</sup> in 1846
  - Henery George Van Orsdel<sup>567</sup> in 1849
572. MARY B BOICE (Anne's aunt) was born to Ephriam Boice<sup>586</sup> and Mary Vicker Smock<sup>587</sup>.
573. GIDEON WOOD (Anne's uncle by marriage).  
Gideon Wood married Mary B Boice<sup>572</sup> in 1820 in Harrisburg, Mercer, Kentucky, USA.
574. KATIE BOICE (Anne's aunt) was born in Harrisburg, Mercer, Kentucky, USA to Ephriam Boice<sup>586</sup> and Mary Vicker Smock<sup>587</sup>.
575. SAMUEL RYNEARSON (Anne's uncle by marriage).  
Samuel Rynearson married Katie Boice<sup>574</sup>.
576. JACOB BOICE (Anne's uncle) was born in Harrisburg, Mercer, Kentucky, USA to Ephriam Boice<sup>586</sup> and Mary Vicker Smock<sup>587</sup>.
577. JANE VAN ORSEDEL (Anne's aunt by marriage).  
Jacob Boice<sup>576</sup> married Jane Van Orsdel.
578. GEORGE SCOMP (Anne's uncle) was born to Jacob Scomp<sup>588</sup> and Mary Vicker Smock<sup>587</sup>.
579. JOHN SCOMP (Anne's uncle) was born to Jacob Scomp<sup>588</sup> and Mary Vicker Smock<sup>587</sup>.
580. HENRY SCOMP (Anne's uncle) was born to Jacob Scomp<sup>588</sup> and Mary Vicker Smock<sup>587</sup>.
581. ANNIE E SCOMP (Anne's aunt) was born to Jacob Scomp<sup>588</sup> and Mary Vicker Smock<sup>587</sup>.
582. SALLY SCOMP (Anne's aunt) was born to Jacob Scomp<sup>588</sup> and Mary Vicker Smock<sup>587</sup>.
583. HANNA SCOMP (Anne's aunt) was born to Jacob Scomp<sup>588</sup> and Mary Vicker Smock<sup>587</sup>.

**Same generation as James's Parents**

584. ABRAM VAN ORSDEL VAN ORSDEL (Anne's grandfather).
585. ELLEN UNKNOWN (Anne's grandmother).  
Abram Van Orsdel Van Orsdel<sup>584</sup> married Ellen Unknown. They had one son:  
Abram F Van Orsdel, Jr.<sup>570</sup> in 1808
586. EPHRIAM BOICE (Anne's grandfather).
587. MARY VICKER SMOCK (Anne's grandmother).  
(Mary married twice. She was married to Ephriam Boice<sup>586</sup> and Jacob Scomp<sup>588</sup>.)  
Ephriam Boice<sup>586</sup> married Mary Vicker Smock. They had four children:  
Rebecca K Boice<sup>571</sup> in 1810  
Mary B Boice<sup>572</sup>  
Katie Boice<sup>574</sup>  
Jacob Boice<sup>576</sup>
588. JACOB SCOMP (Anne's grandmother's husband) was born in New Jersey, USA.

Jacob Scomp married Mary Vicker Smock<sup>587</sup>. They had six children:

- George Scomp<sup>578</sup>
- John Scomp<sup>579</sup>
- Henry Scomp<sup>580</sup>
- Annie E Scomp<sup>581</sup>
- Sally Scomp<sup>582</sup>
- Hanna Scomp<sup>583</sup>

**11. INDIRECTLY RELATED via MARY ELIZABETH SKELTON<sup>511</sup>**  
(Frances Elizabeth Kennedy's Sister-in-law)

**Same generation as James's Children**

589. JAMES FRANKLIN SKELTON (Mary's father).

590. MARY JANE UNKNOWN (Mary's mother).

James Franklin Skelton<sup>589</sup> married Mary Jane Unknown. They had one daughter:  
Mary Elizabeth Skelton<sup>511</sup> in 1863

**12. INDIRECTLY RELATED via CRISTINE SAPP<sup>433</sup>**  
(John David Kelley's Sister-in-law)

**Same generation as James's Great-Great-Grandchildren**

591. EVERETT SAPP (Cristine's brother) was born to John Harvey Sapp<sup>596</sup> and Mary Miranda Unknown<sup>597</sup>.
592. LIZZIE SAPP (Cristine's sister) was born to John Harvey Sapp<sup>596</sup> and Mary Miranda Unknown<sup>597</sup>.
593. ARCHIE SAPP (Cristine's brother) was born to John Harvey Sapp<sup>596</sup> and Mary Miranda Unknown<sup>597</sup>.
594. ROY SAPP (Cristine's brother) was born to John Harvey Sapp<sup>596</sup> and Mary Miranda Unknown<sup>597</sup>.
595. CLARA BELLE SAPP (Cristine's sister) was born to John Harvey Sapp<sup>596</sup> and Mary Miranda Unknown<sup>597</sup>.

**Same generation as James's Great-Grandchildren**

596. JOHN HARVEY SAPP (Cristine's father). John died on 18 December 1958.
597. MARY MIRANDA UNKNOWN (Cristine's mother). Mary died in 1946.
- John Harvey Sapp<sup>596</sup> married Mary Miranda Unknown. They had six children:
- Cristine Sapp<sup>433</sup> in 1919
  - Everett Sapp<sup>591</sup>
  - Lizzie Sapp<sup>592</sup>
  - Archie Sapp<sup>593</sup>
  - Roy Sapp<sup>594</sup>
  - Clara Belle Sapp<sup>595</sup>

**13. INDIRECTLY RELATED via BETTY EARLYWINE**<sup>435</sup>  
(John David Kelley's Sister-in-law)

**Same generation as James's Great-Grandchildren**

598. LOU KELLEY (Betty's mother).

Lou Kelley was married. She had one daughter:

Betty Earlywine<sup>435</sup>

## 14. FAMILY TREES

The following family trees each show the reported children, parents, grandparents and great-grandparents of a family group. In order to reduce redundancy, any family group which is wholly included within another family tree may not be reported separately.

Above each of the great-grandparent boxes (top row), a continuation family tree reference number in angle brackets is shown if the great-grandparent is recorded as a child in the continuation tree. A continuation reference number is also shown to the left of a grandparent or parent box if that individual has siblings reported in the continuation tree; and beneath a child box (bottom row) if that individual has children reported in the continuation tree.

In cases of multiple marriages, a continuation reference number preceded by "=" is shown to the right of a parent box. This number references the previous and/or next tree in which that individual is shown with another partner.

1. BOYD, James Vencent & SOBO, Brenda Sue
2. SOBO, Randy Eugene & JOHNSON, Kim Eileen
3. KENNADAY, Todd & JORGENSEN, Joyce Ellen
4. HUNNICUTT, Cristian & KELLEY, Lisa June
5. ASBURY, James Mickel & KELLEY, Lisa June
6. MEYER, Mark & JONES, Sherrie (Like a Daughter)
7. LETT, Tim & CURTIS, Anita Carol
8. CURTIS, David Earl & BENNER, Toni
9. SOBO, Cornell Alexander, Jr. & KENNADAY, Charlotte Arlene
10. KENNADAY, Thomas Eugene & BENSON, Janice
11. GEPPERT, August Henry & KENNADAY, Patty Ray
12. RAMSEY, Earl Efton (Butch) & HUBBARD, Rosa L
13. HAYES, Bob & RAMSEY, Afton Ernstine (Marier)
14. KENNADAY, Jack Wayne & BRANT, Carol Lee
15. KENNADAY, Gary Forrest & THOMPSON, Alice
16. KENNADAY, Michael Joseph & WILLIAMS, Carolyn
17. LOTT, Jimmy Ray & DOLLAR HYDE, Ellen
18. BLUNT, Al & LOTT, Rosa Lee
19. LOTT, Calvin Jay & STURGESS, Jo Ann
20. SLOANE, Mr. & LOTT, Mable Bea
21. KELLEY, Ronald David, Sr. & FITZPATRICK, Betty Carol
22. CURTIS, Norman Perry & KELLEY, Carolyn June
23. JOHNSON, Gordon & MARIER, Sherry Jean
24. FORRESTER, Micheal A & MARIER, Jane Marie
25. KENNADAY, David Debernardi & SMITH, Paula Jo
26. KENNADAY, Steven Scott & LAVELLE, Catherine Susan
27. KENNADAY, Steven Scott & REED, Danielle
28. KENNADAY, Fredrick Frank & YOUNG, Brigid Ann
29. WHITMAN, Nelson Chester & PENDERGRASS, Cecelia Kay
30. WHITMAN, Nelson Chester & CORLETT, Claudette Irene
31. WHITMAN, Boyd David & THOMPSON, Carolyn M
32. WHITMAN, Richard Ward & JOUETT, Robin Knipp
33. BARTLETT, Joseph Grant & WHITMAN, Charlotte Louize
34. THOMPSON, Tommy M & WHITMAN, Marcella Ann
35. SMITH, Fred Winton & WHITMAN, Phillis Lana
36. SELF, Stanley Howard & WHITMAN, Laurel Alice
37. PAGE, Ronald Otis & CAIRNS, Linda Ann
38. CAMPBELL, Craig & CAIRNS, Christine Marie
39. CAIRNS, Jack Lavoy, Jr. & CASSLER, Rebecca
40. HANSEN, Alan & CAIRNS, Elizabeth Kay
41. CAIRNS, William Wayne & PORTER, Kae
42. COOPER, John Ellery & CAIRNS, Rebecca Gay
43. JEBENS, Carlie & WILSON, Phyllis Ann
44. KENNADAY, Thomas Earl & REAM, Gladys Eleanor
45. RAMSEY, Earl N & KENNADAY, Florence Mae
46. STOCKWELL, Ellen (Dude) & KENNADAY, Forest Jack
47. LOTT, Calvin & KENNADAY, Rose Marie
48. KELLEY, John David & KENNADAY, Iva June
49. JOHNSON, Gordon & KENNADAY, Bonnie Jean
50. MARIER, James Martin & KENNADAY, Bonnie Jean
51. KENNADAY, Lincoln Frank & DEBERNARDI, Joan Olivia

52. WHITMAN, Bruce Douglas & DAVIDSON, Frances Amonda
53. ROGERSON, Robert Orrin & DAVIDSON, Vita Maude
54. BLACKBURN, Harvey Alton & DAVIDSON, Louize Gertrude
55. DAVIDSON, Chester Clark & DADISMAN, Norma Hilda
56. ACKERSON, Walter Cecil & DAVIDSON, Eleanora Alice
57. DAVIDSON, Charles Daniel & NOLLER, Earlene Dee
58. HARNED, David Debernardi & DAVIDSON, Myrtle Rae
59. REDMAN, Ronald Clark & DAVIDSON, Myrtle Rae
60. CAIRNS, Jack Lavoy & JOHNSON, Beverly Ann
61. WILSON, Albert Norman & CAIRNS, Margaret Faunita
62. SCHMELING, Craig Martin & CAIRNS, Judy Ann
63. PETERS, Fred & KENNADAY, Rosa Marie
64. STEWART, Ed & KENNADAY, Anna Ruth
65. KENNADAY, Frank Forest & PIERCE, Mable
66. KENNADAY, Edward Thomas & MANNAHAN, Alice
67. DAVIDSON, Fairfax Harry & KENNADAY, Alice Oda May
68. KENNADAY, Charles Fredrick & BAYS, Margaret
69. CAIRNS, Logan Turner & KENNADAY, Emma Helen
70. KENNADAY, Loyd Andrew & HENDERSON, Inez
71. KENNADAY, Charles Alonzo & KENNEDY, Frances Elizabeth
72. KENNADAY, Andrew Jackson & MARSHEL, Anna
73. KENNADAY, John Hudson & VAN ORSDEL, Anne Elizabeth
74. KENNADAY, James & HUDSON, Sarah



**1. James Vencent Boyd & Brenda Sue Sobo**

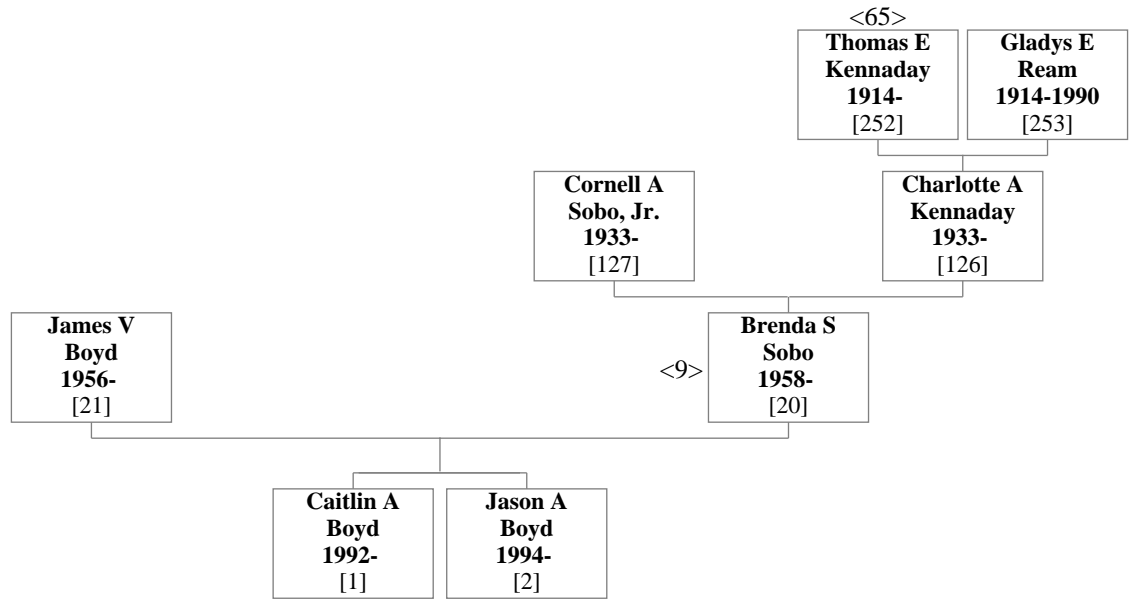

**2. Randy Eugene Sobo & Kim Eileen Johnson**

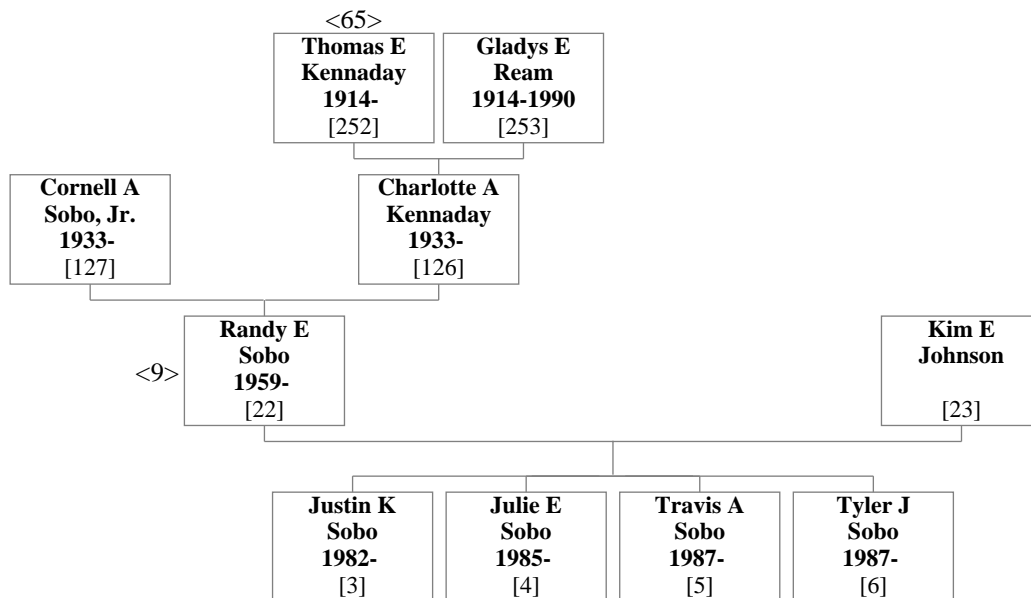

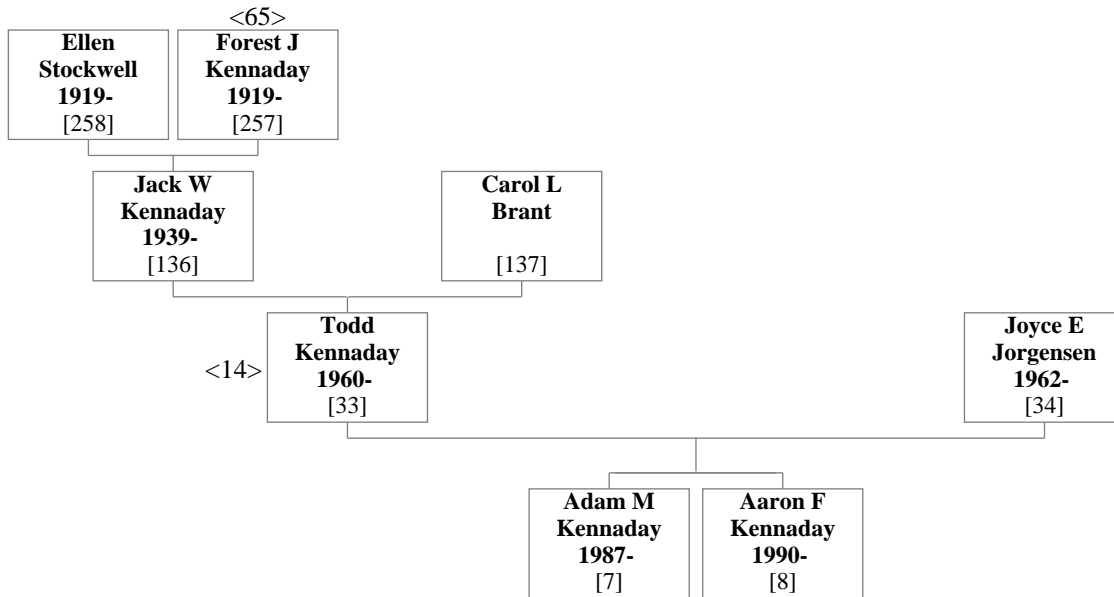
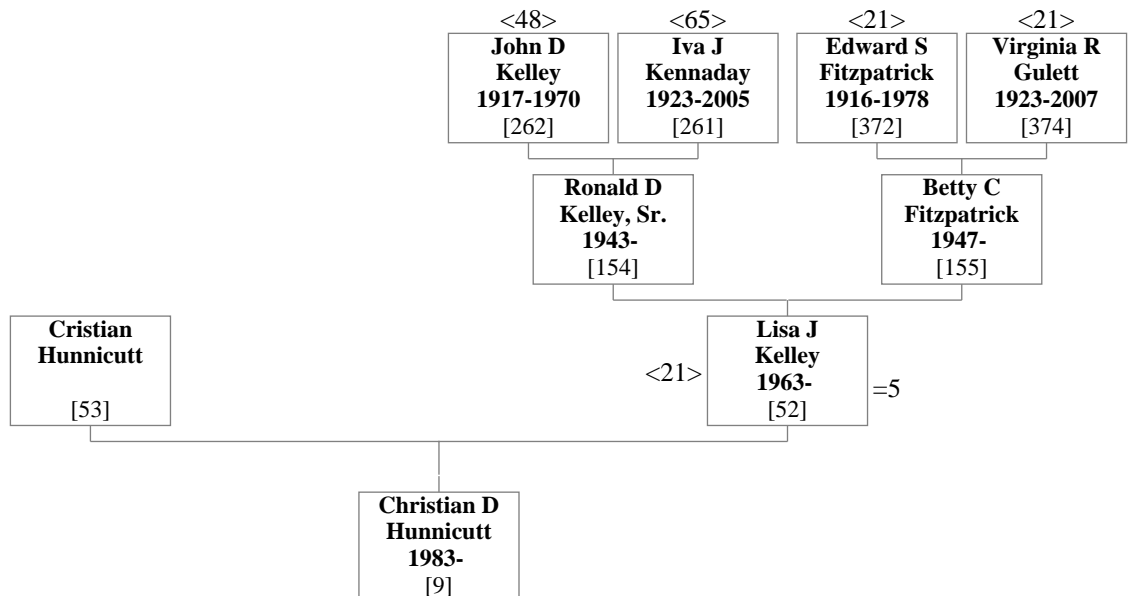
**3. Todd Kennaday & Joyce Ellen Jorgensen****4. Cristian Hunnicutt & Lisa June Kelley**

**5. James Mickel Asbury & Lisa June Kelley**

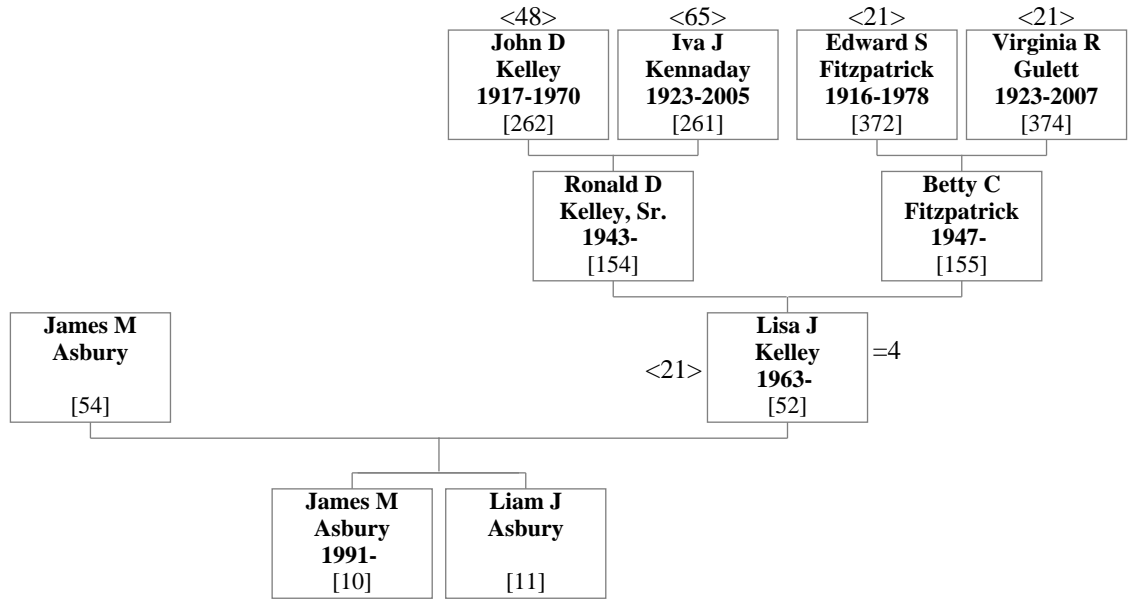

**6. Mark Meyer & Sherrie (Like a Daughter) Jones**

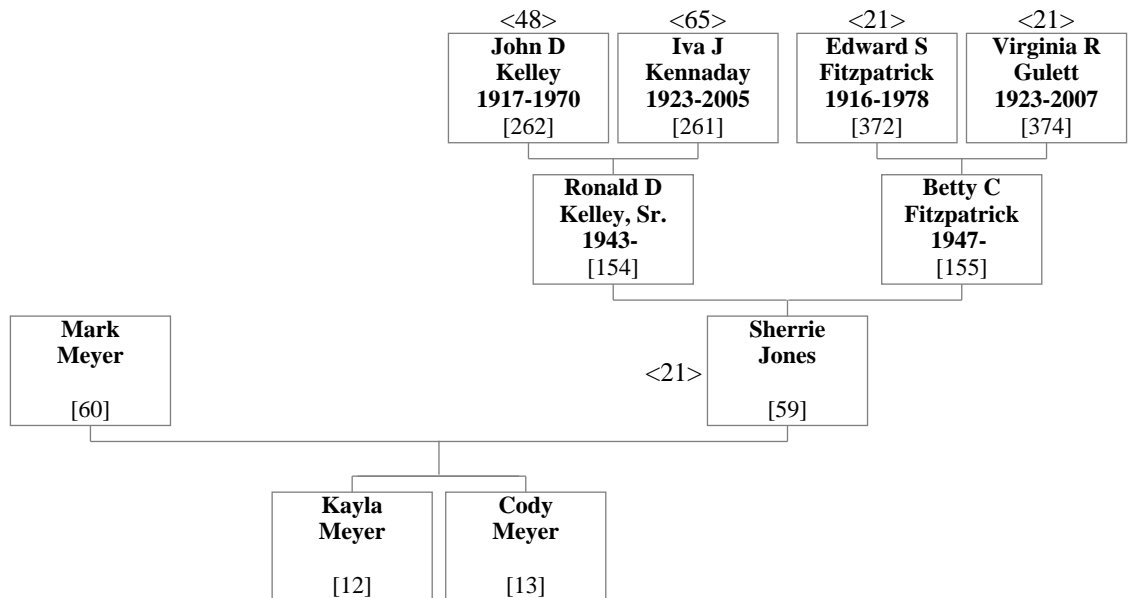

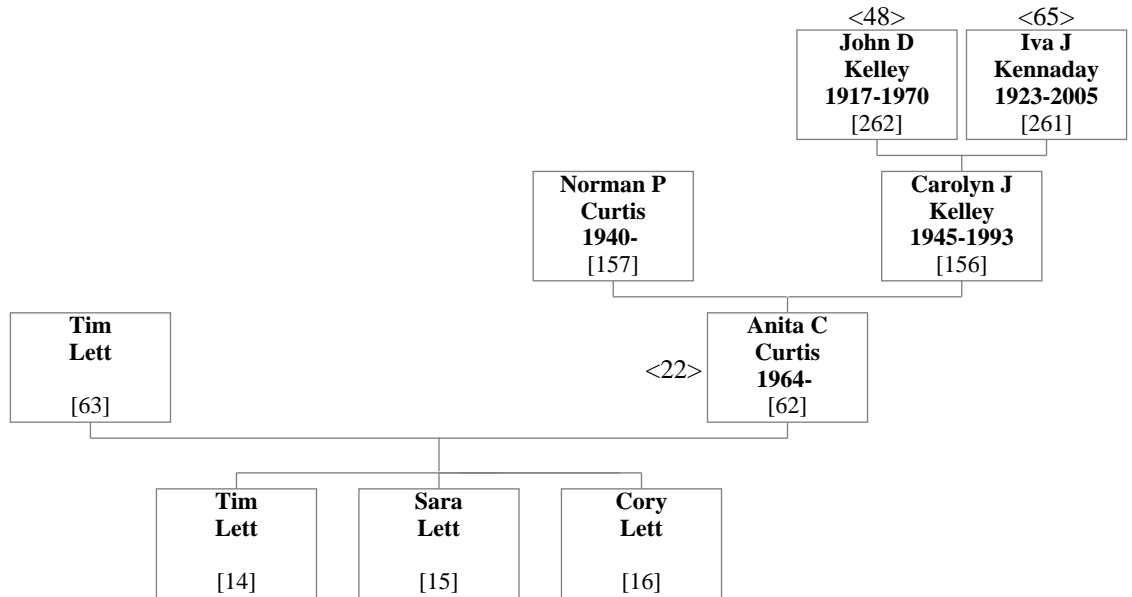
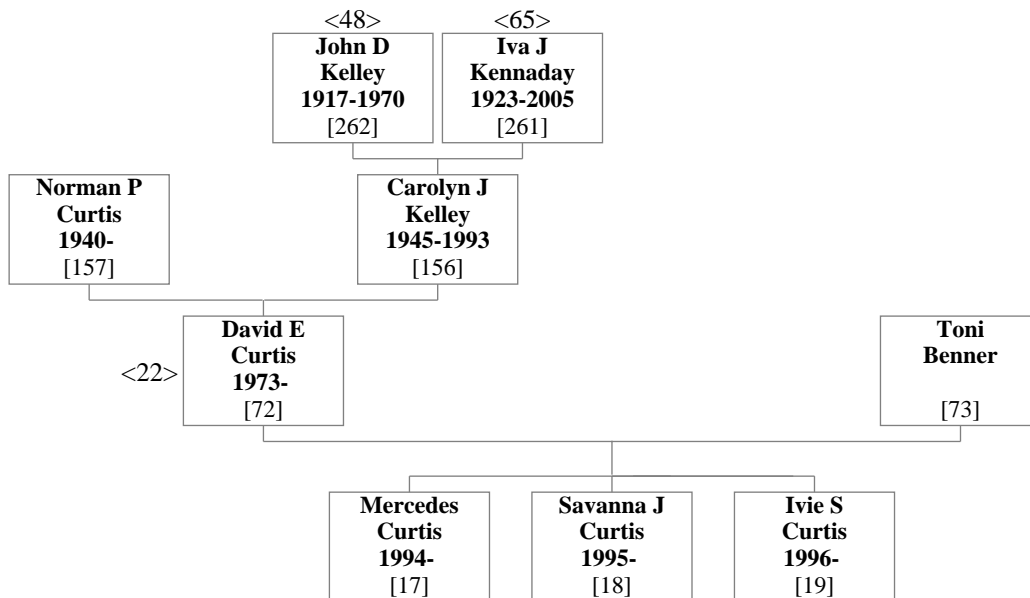
7. Tim Lett & Anita Carol Curtis8. David Earl Curtis & Toni Benner

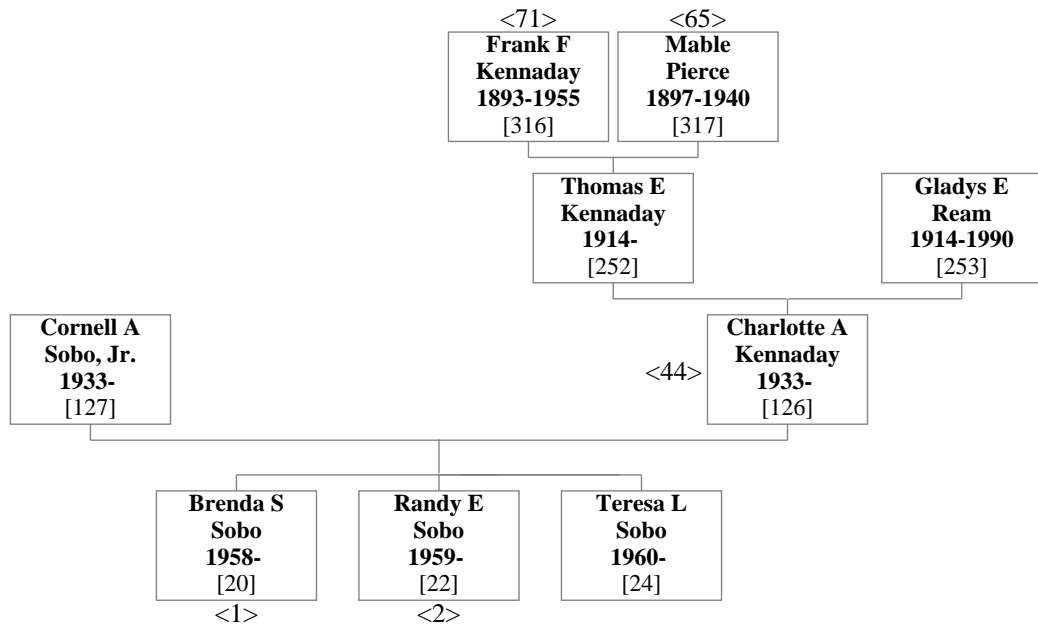
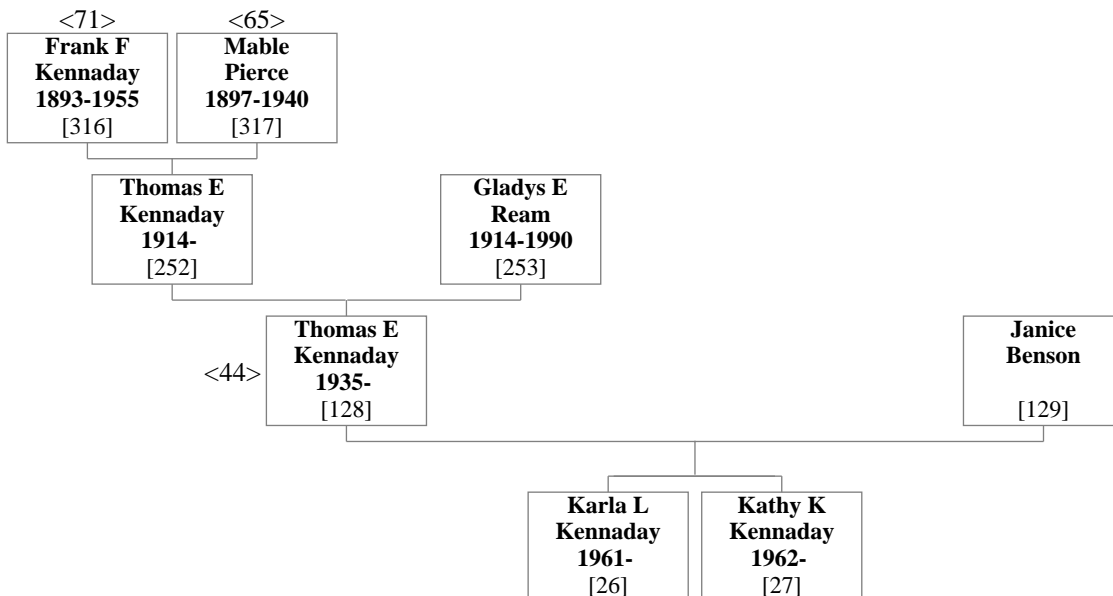
**9. Cornell Alexander Sobo, Jr. & Charlotte Arlene Kennaday****10. Thomas Eugene Kennaday & Janice Benson**

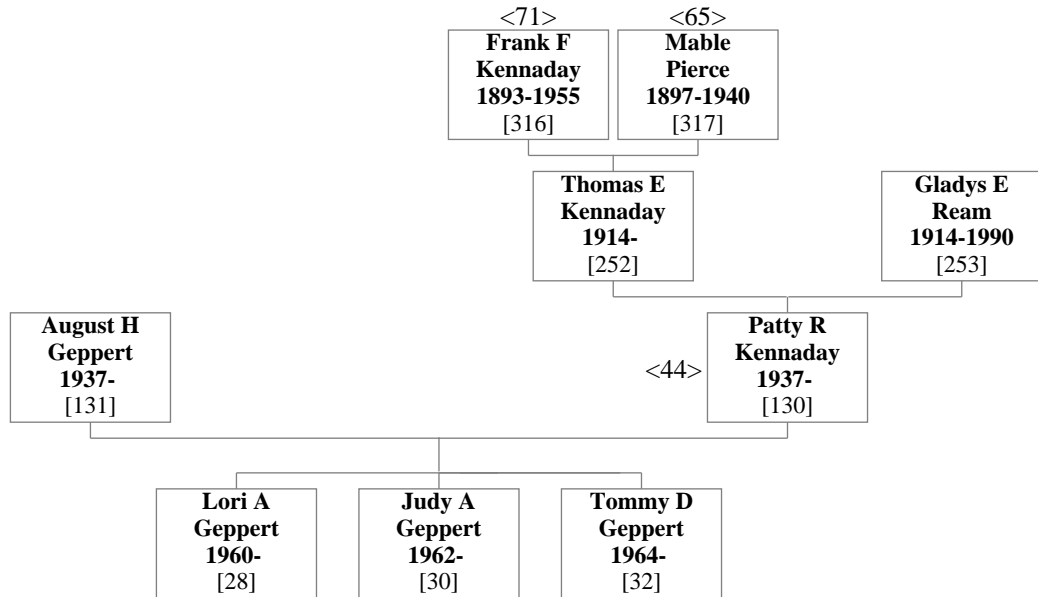
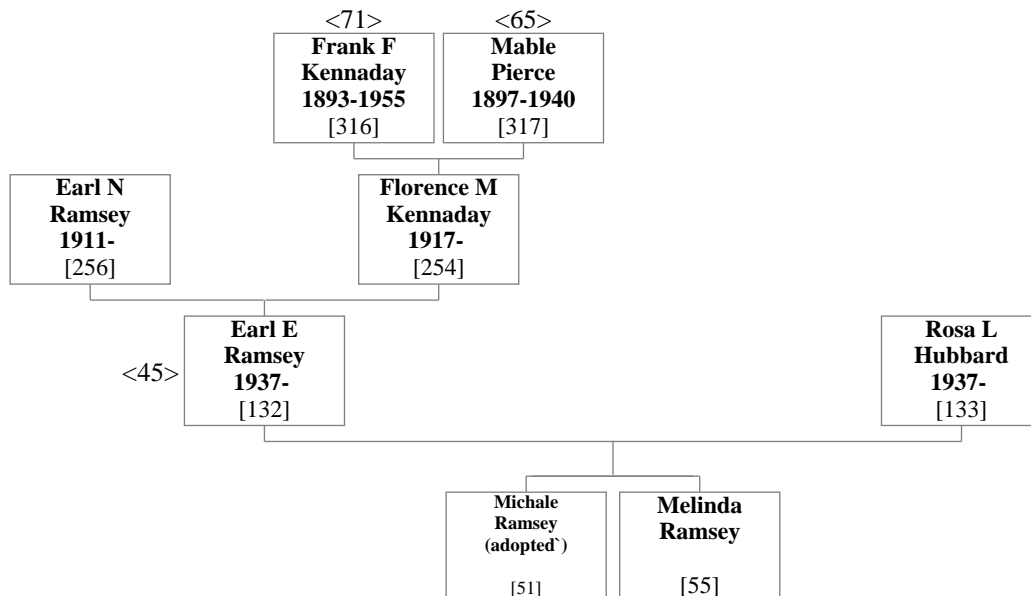
**11. August Henry Geppert & Patty Ray Kennaday****12. Earl Efton (Butch) Ramsey & Rosa L Hubbard**

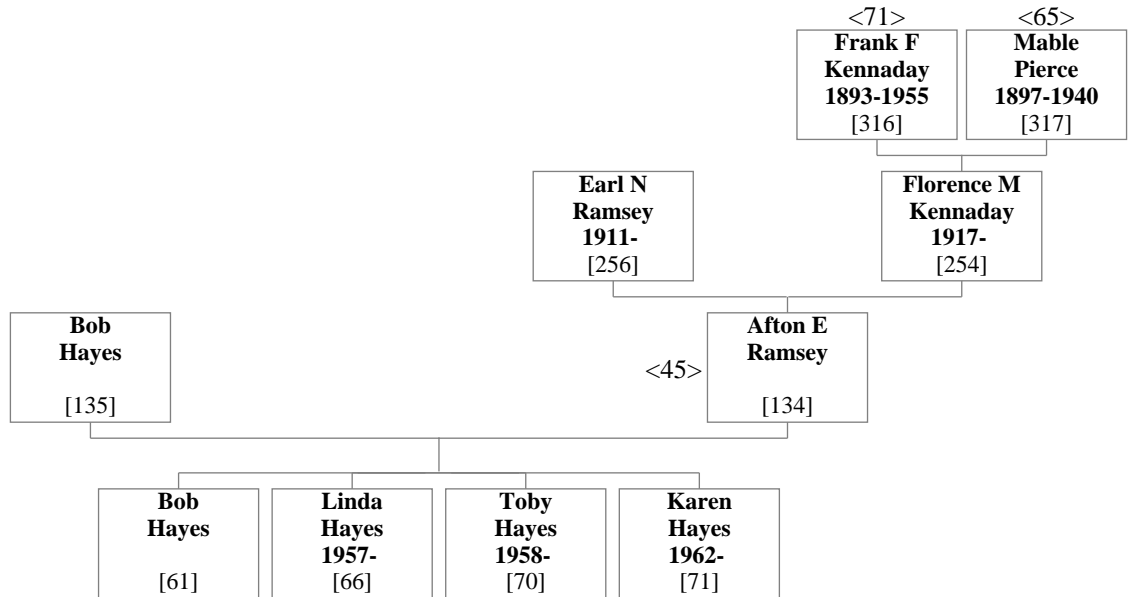
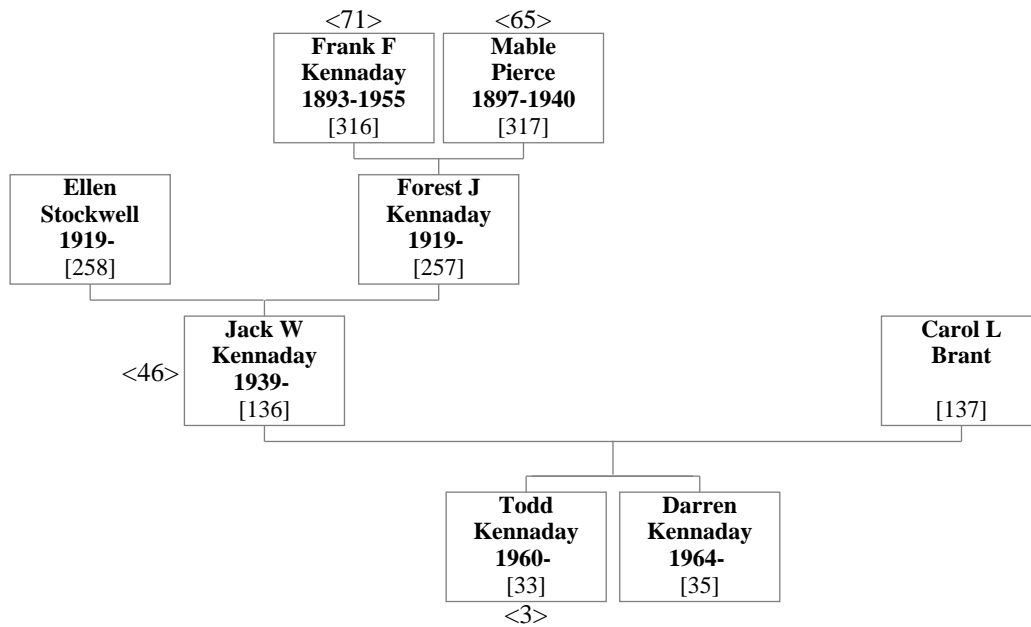
**13. Bob Hayes & Afton Ernstine (Marier) Ramsey****14. Jack Wayne Kennaday & Carol Lee Brant**

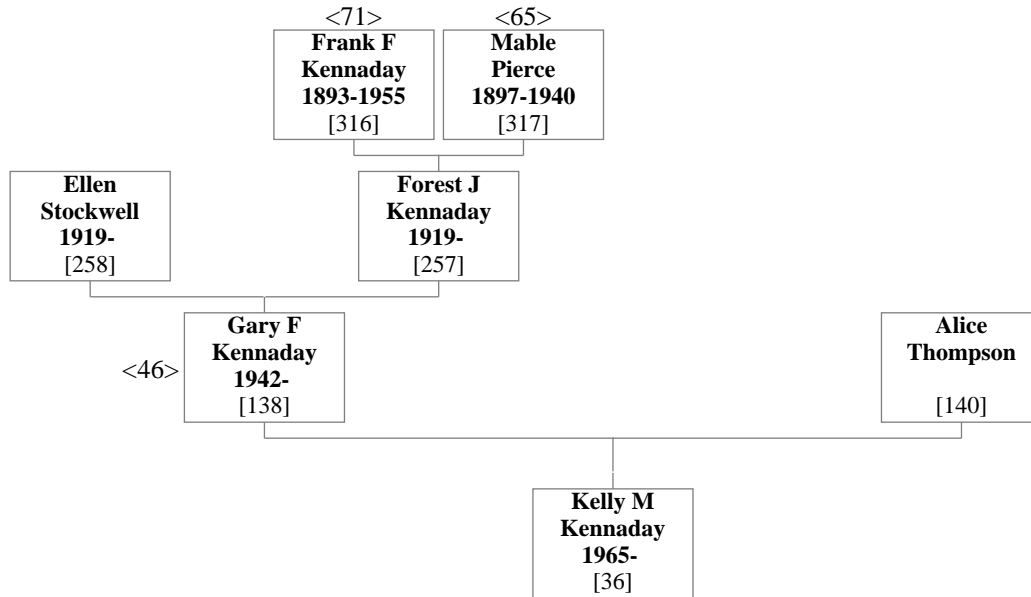
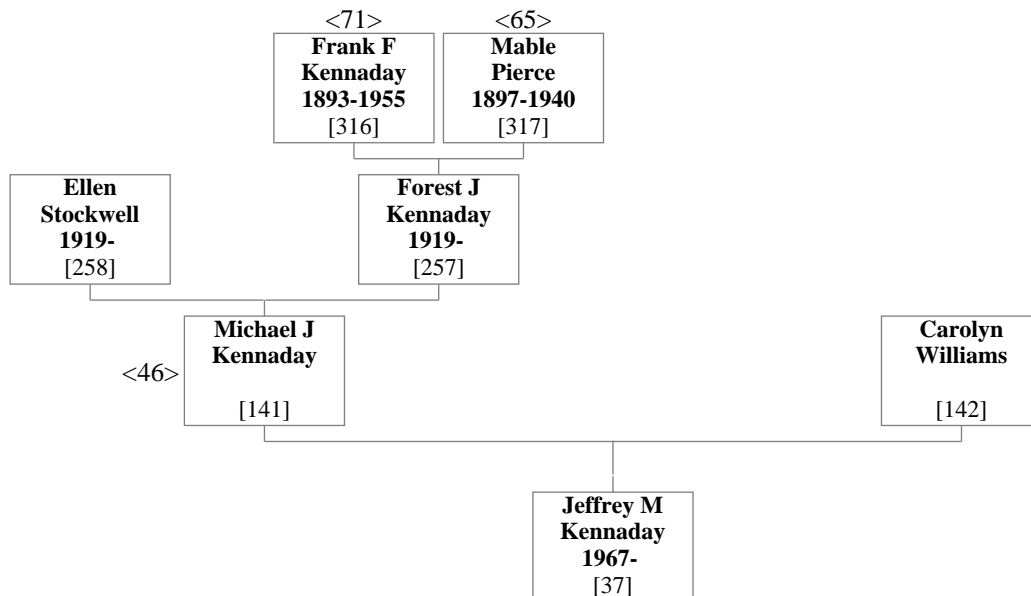
**15. Gary Forrest Kennaday & Alice Thompson****16. Michael Joseph Kennaday & Carolyn Williams**



**17. Jimmy Ray Lott & Ellen Dollar Hyde**

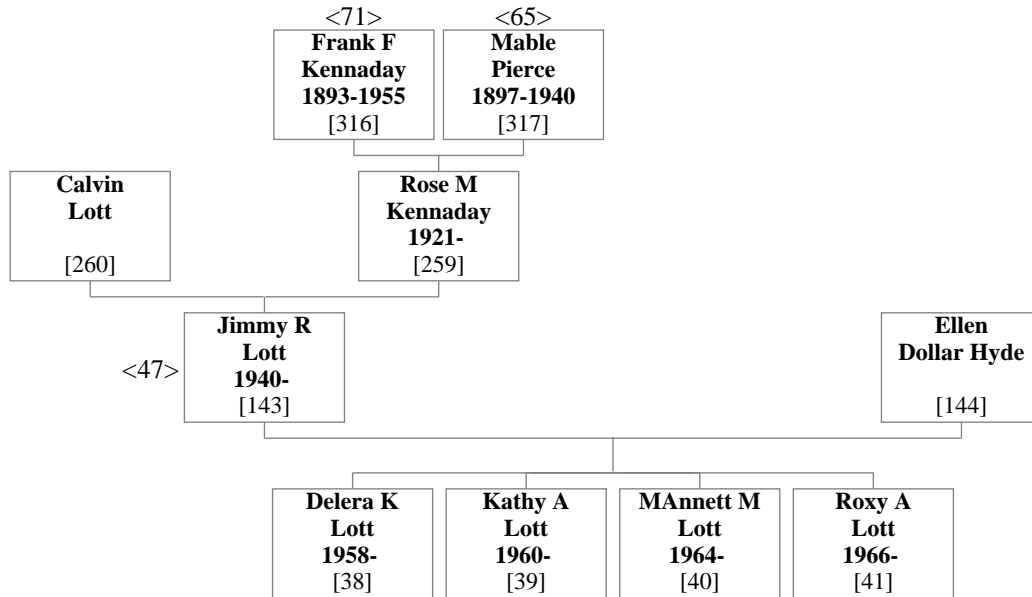

**18. Al Blunt & Rosa Lee Lott**

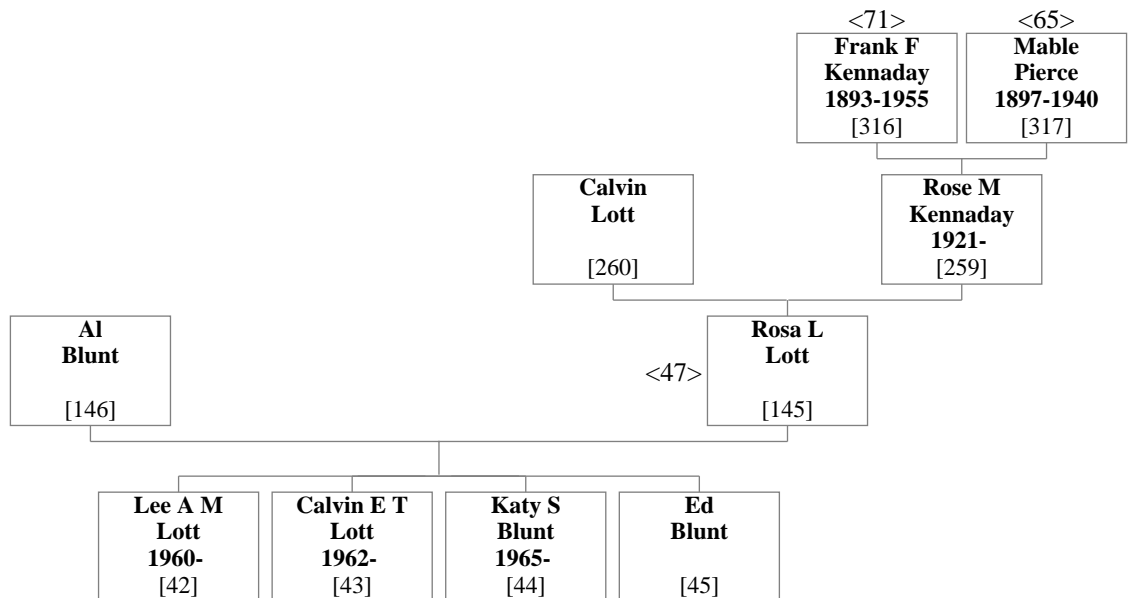

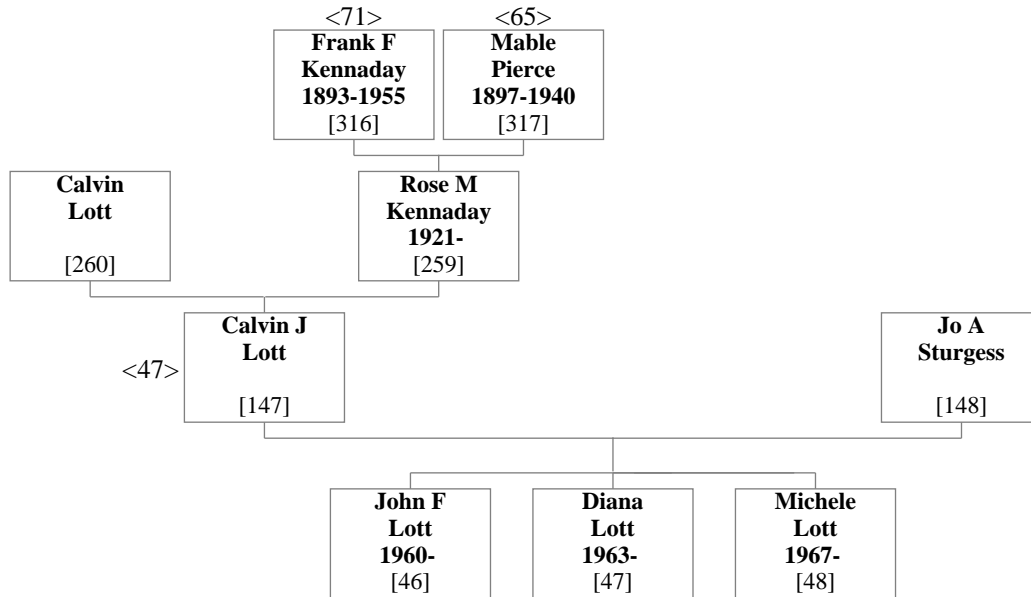
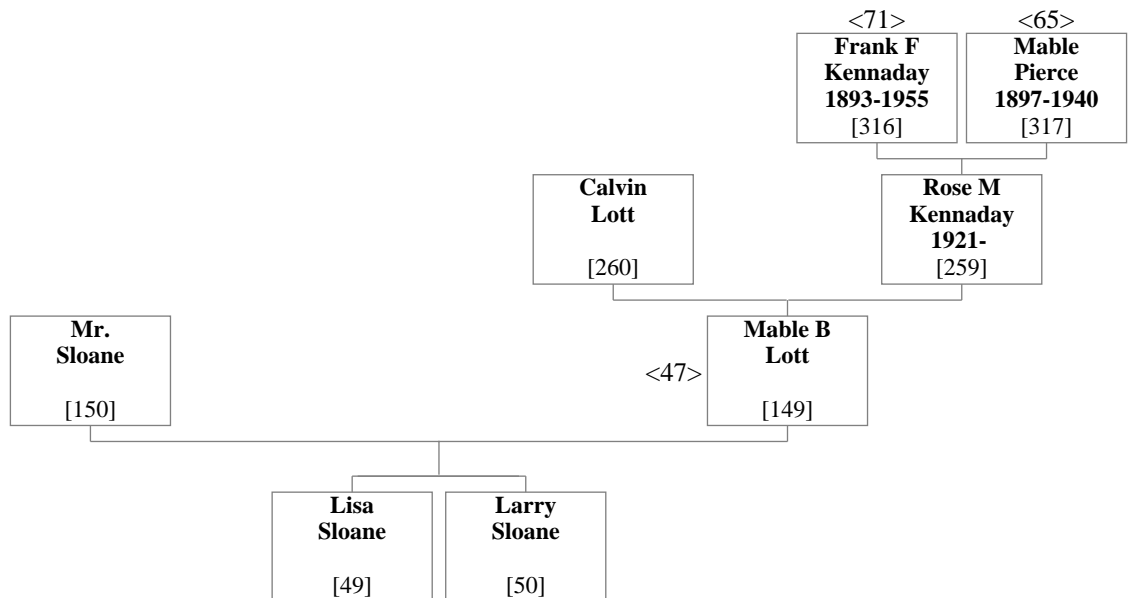
**19. Calvin Jay Lott & Jo Ann Sturgess****20. Mr. Sloane & Mable Bea Lott**

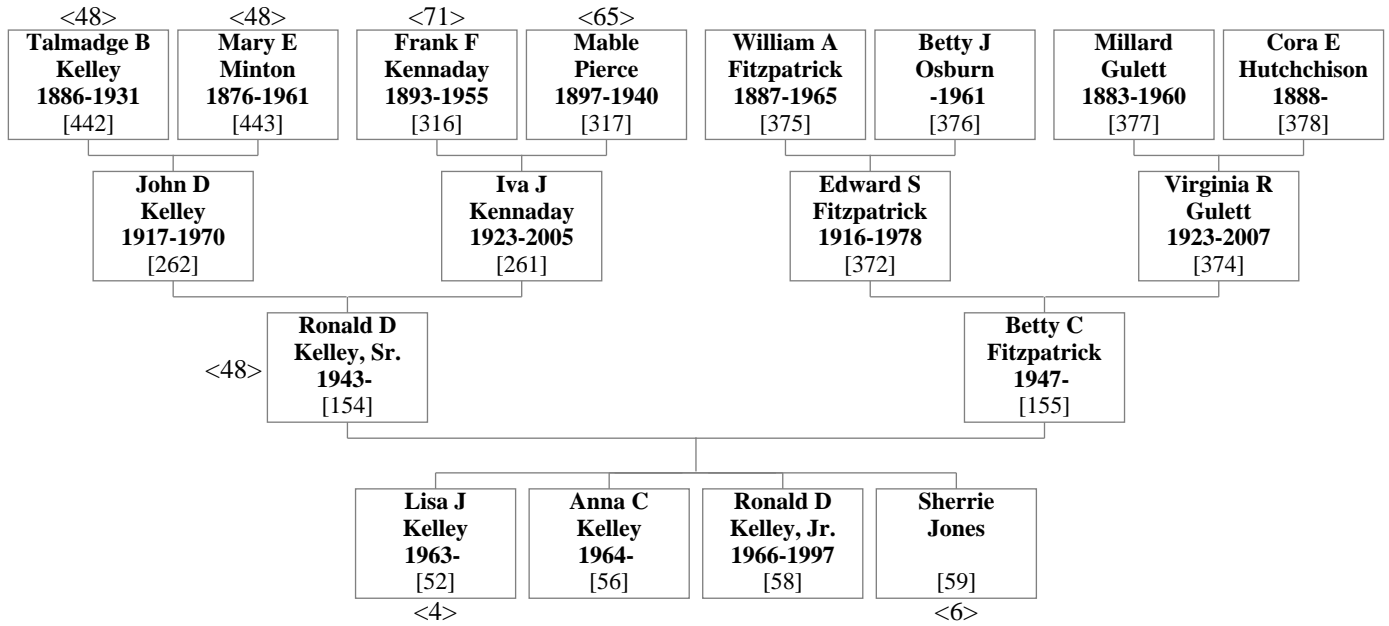
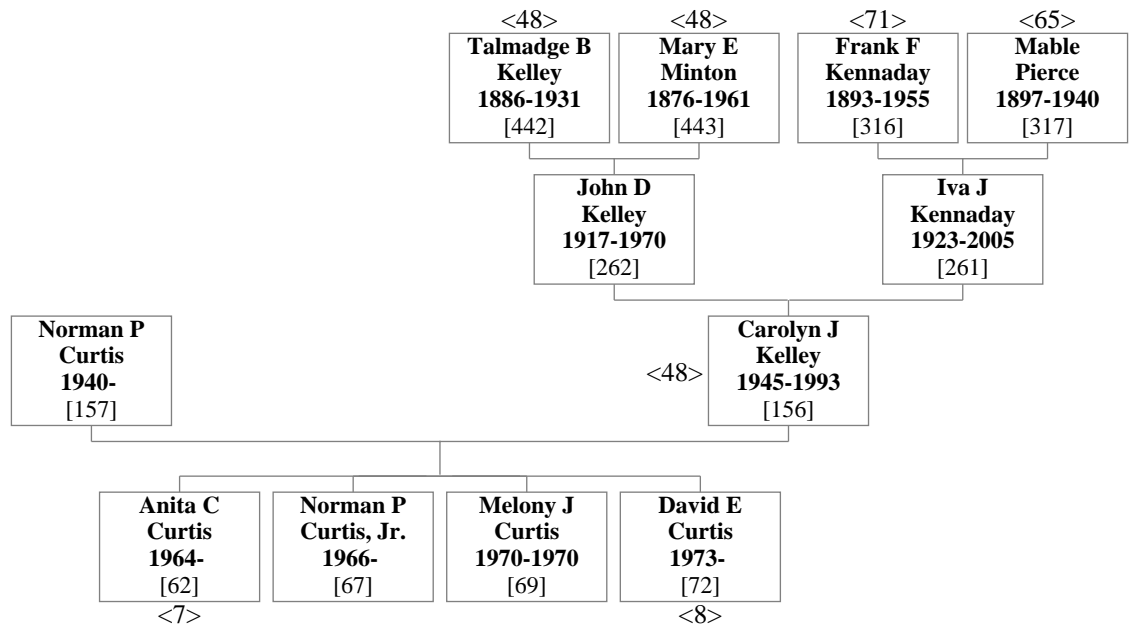
**21. Ronald David Kelley, Sr. & Betty Carol Fitzpatrick****22. Norman Perry Curtis & Carolyn June Kelley**

**23. Gordon Johnson & Sherry Jean Marier**

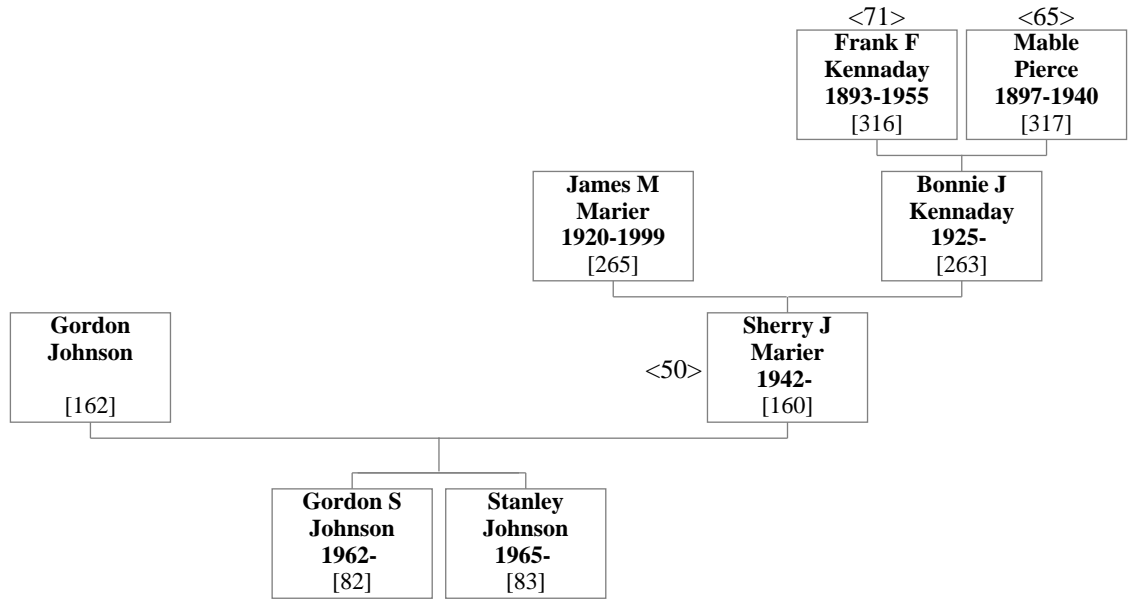

**24. Micheal A Forrester & Jane Marie Marier**

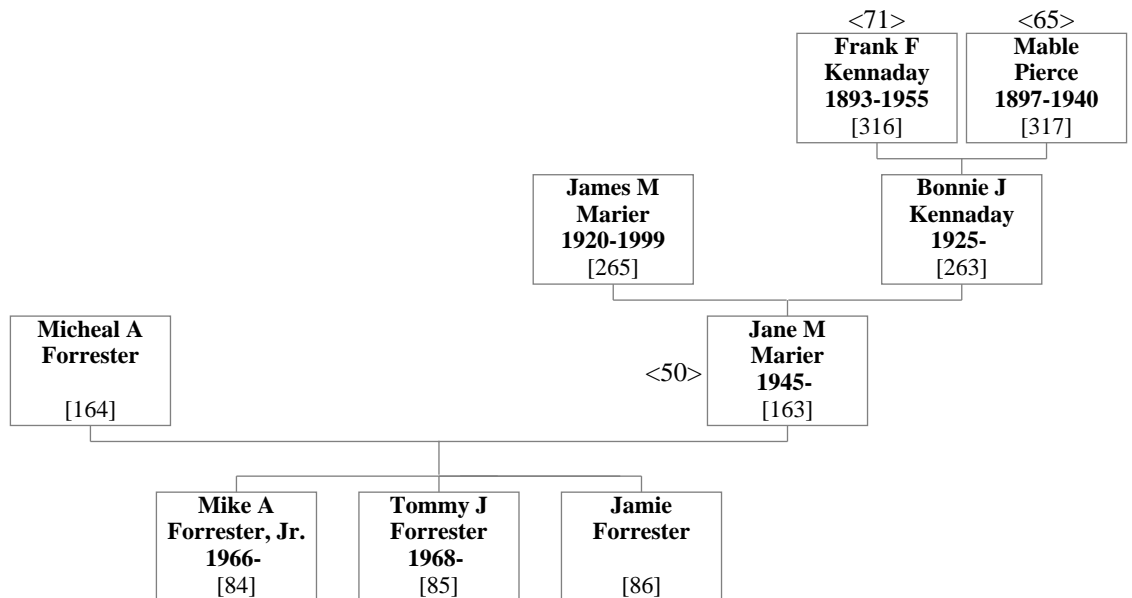

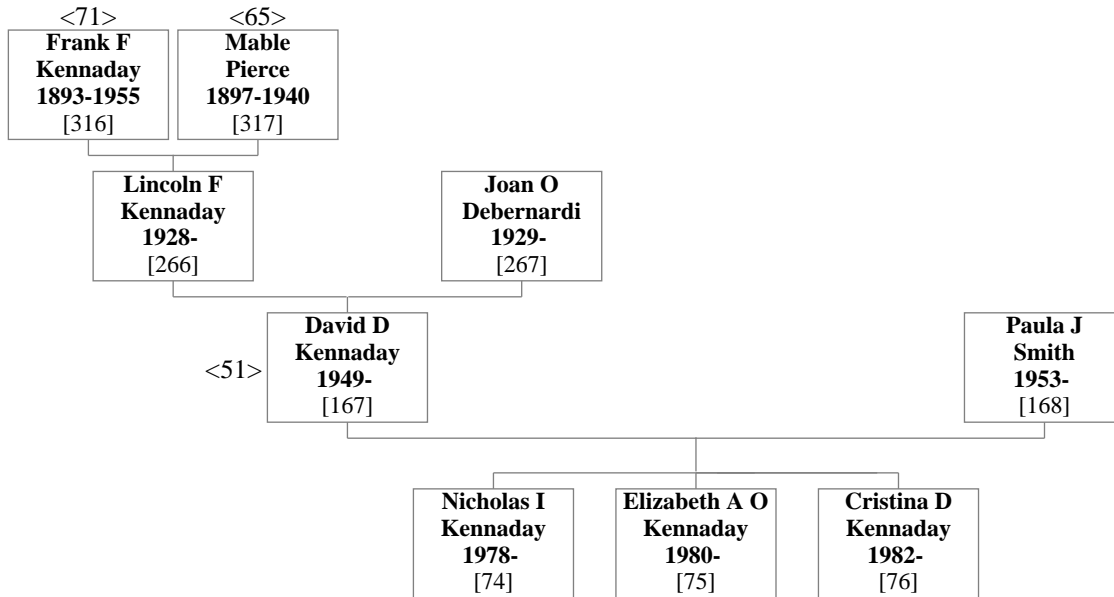
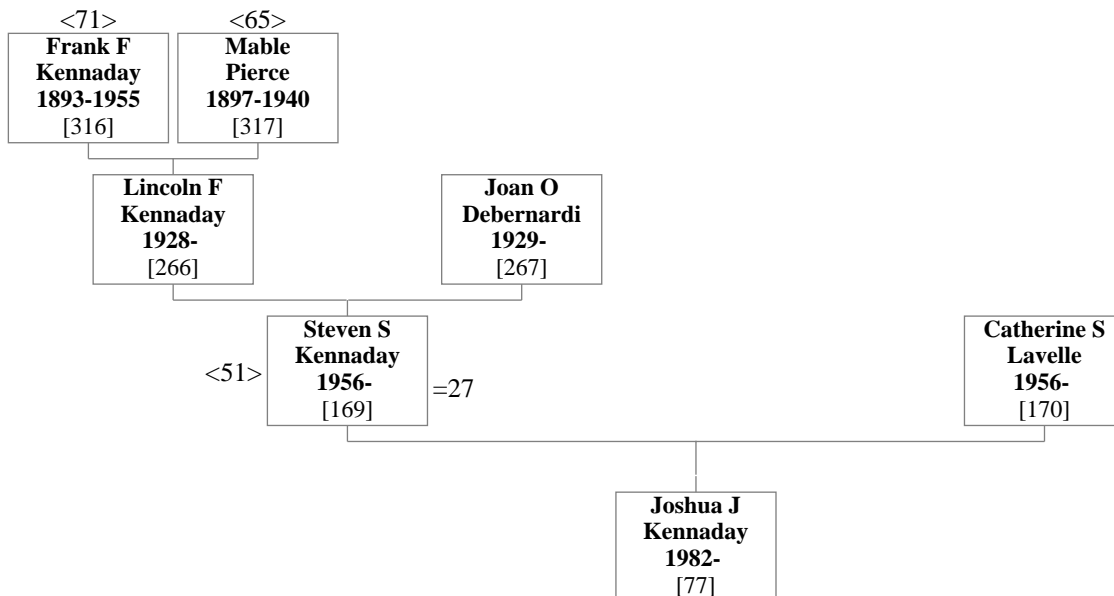
25. David Debernardi Kennaday & Paula Jo Smith26. Steven Scott Kennaday & Catherine Susan Lavelle

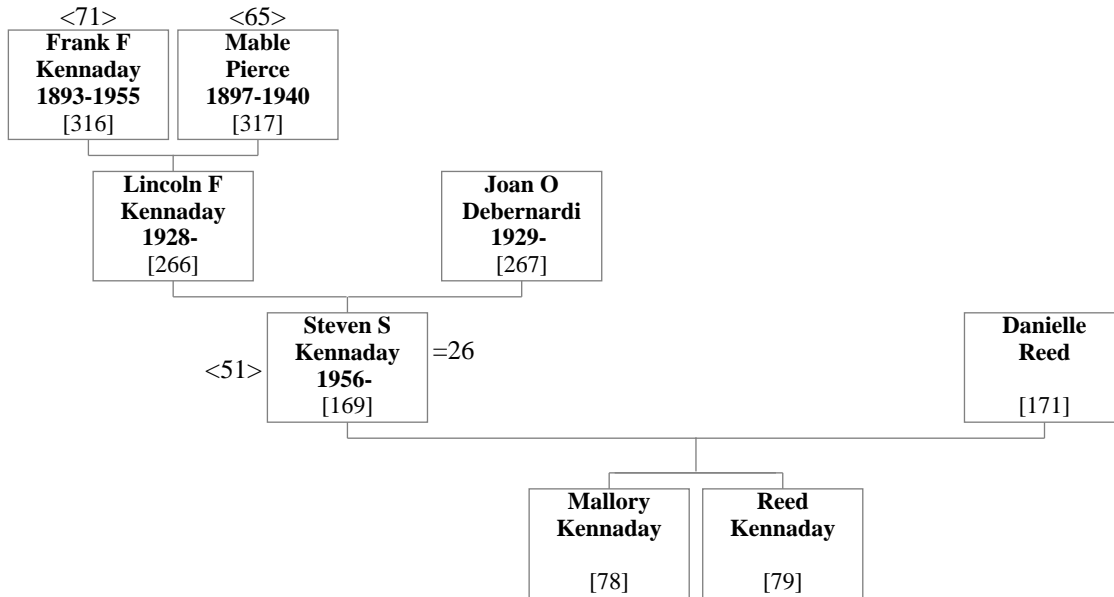
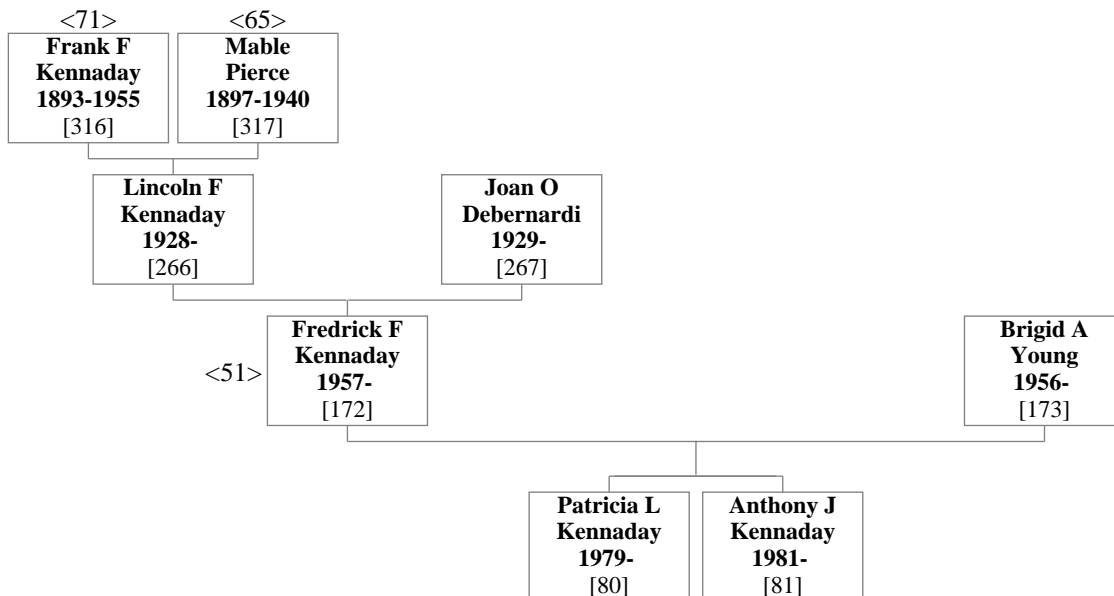
27. Steven Scott Kennaday & Danielle Reed28. Fredrick Frank Kennaday & Brigid Ann Young

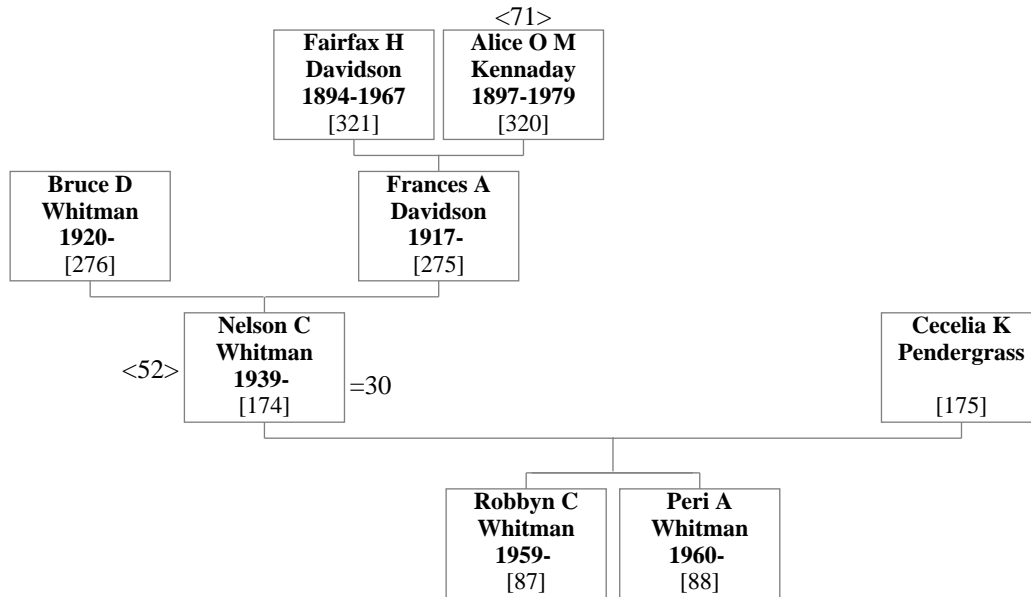
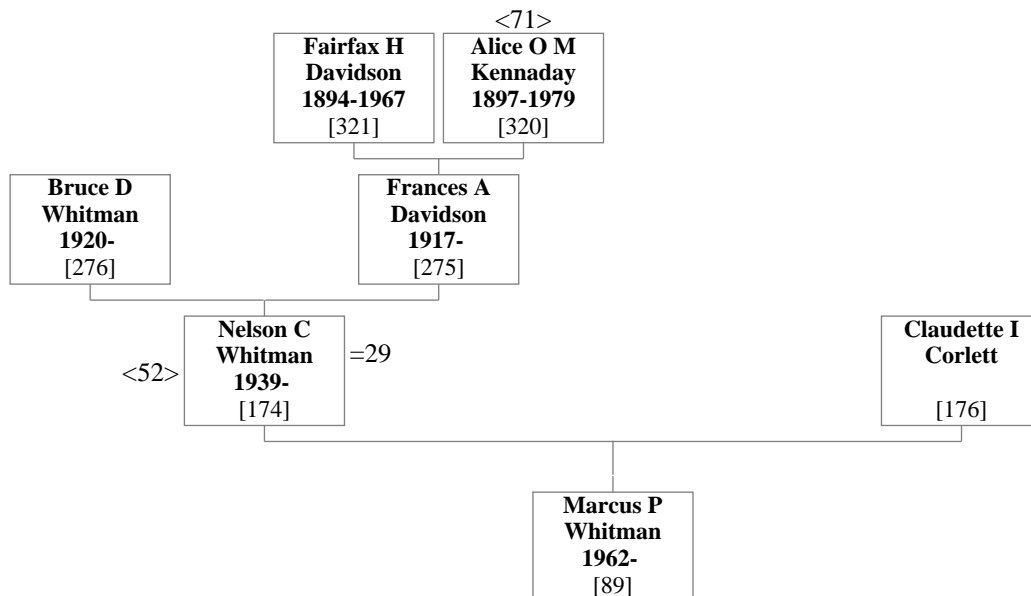
29. Nelson Chester Whitman & Cecelia Kay Pendergrass30. Nelson Chester Whitman & Claudette Irene Corlett

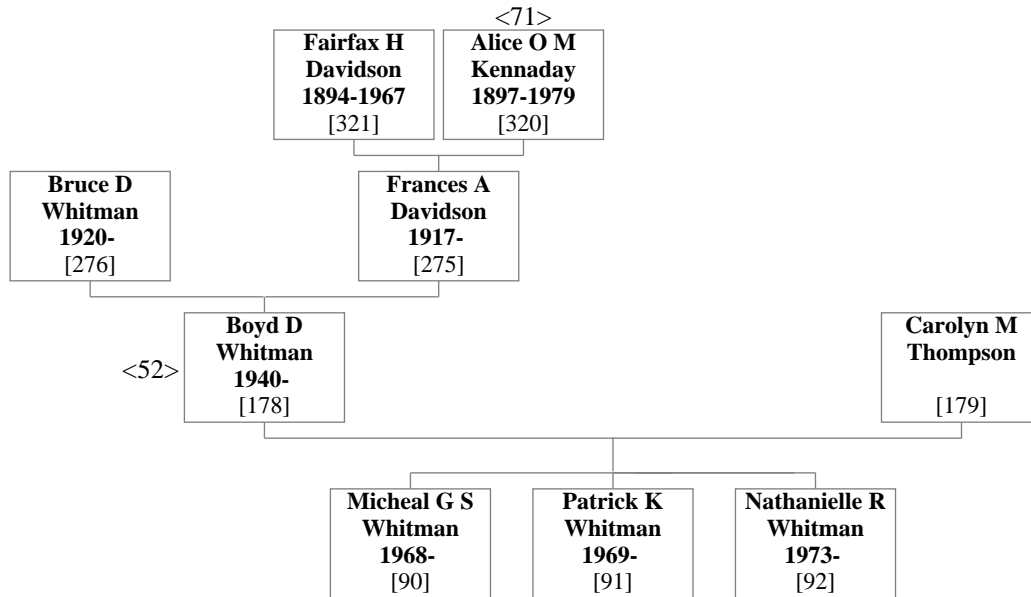
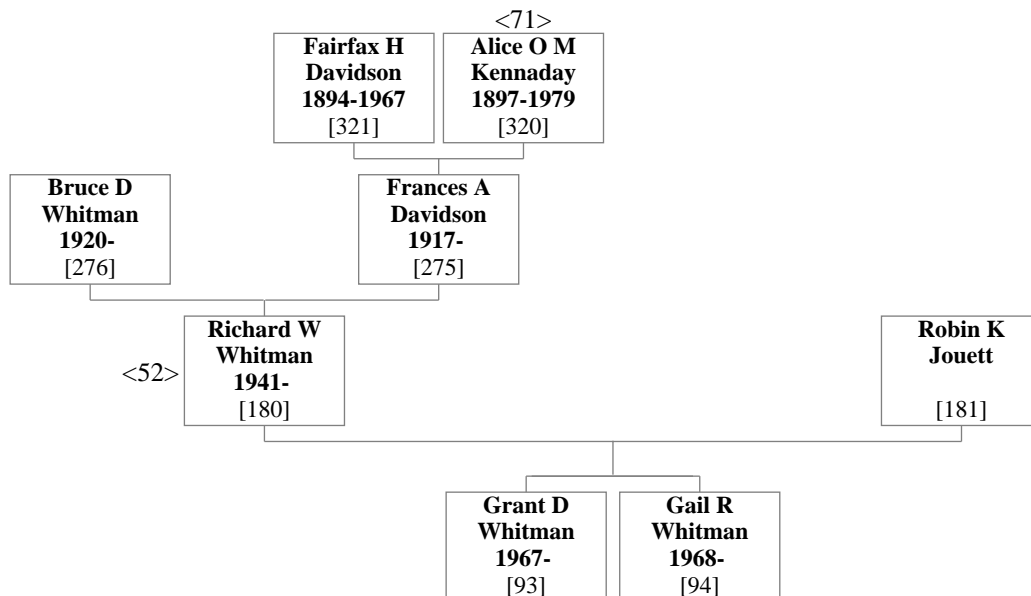
**31. Boyd David Whitman & Carolyn M Thompson****32. Richard Ward Whitman & Robin Knipp Jouett**

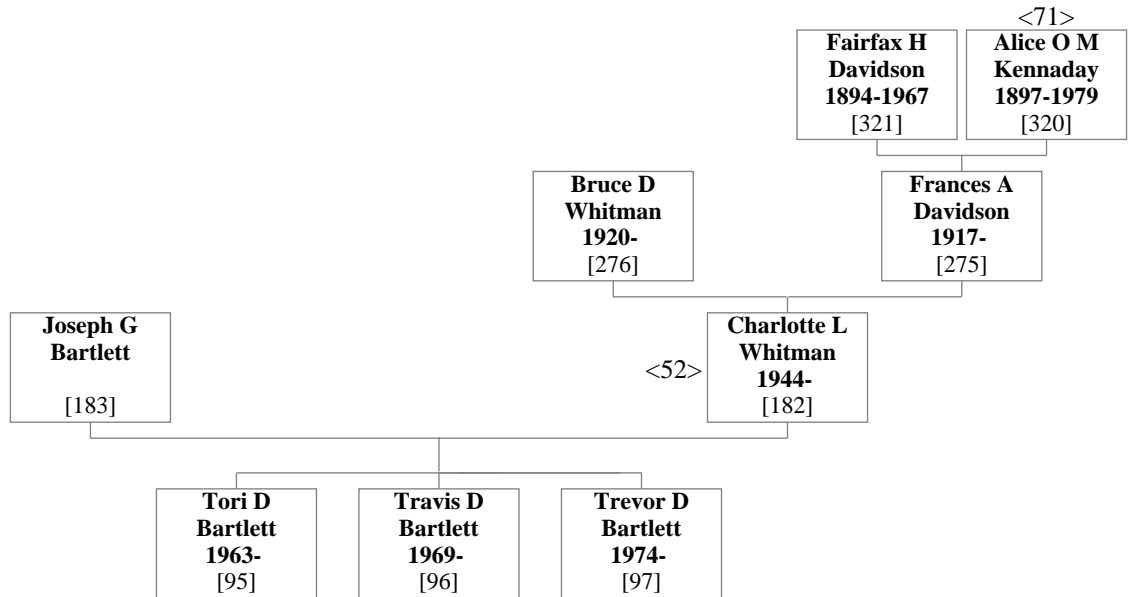
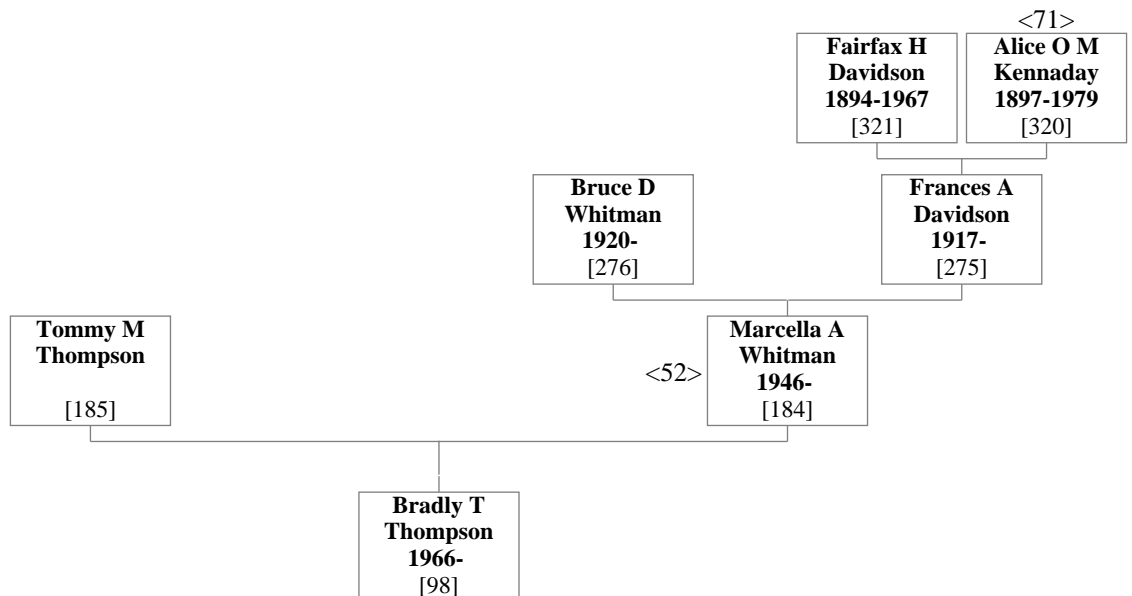

**33. Joseph Grant Bartlett & Charlotte Louise Whitman****34. Tommy M Thompson & Marcella Ann Whitman**

**35. Fred Winton Smith & Phillis Lana Whitman**

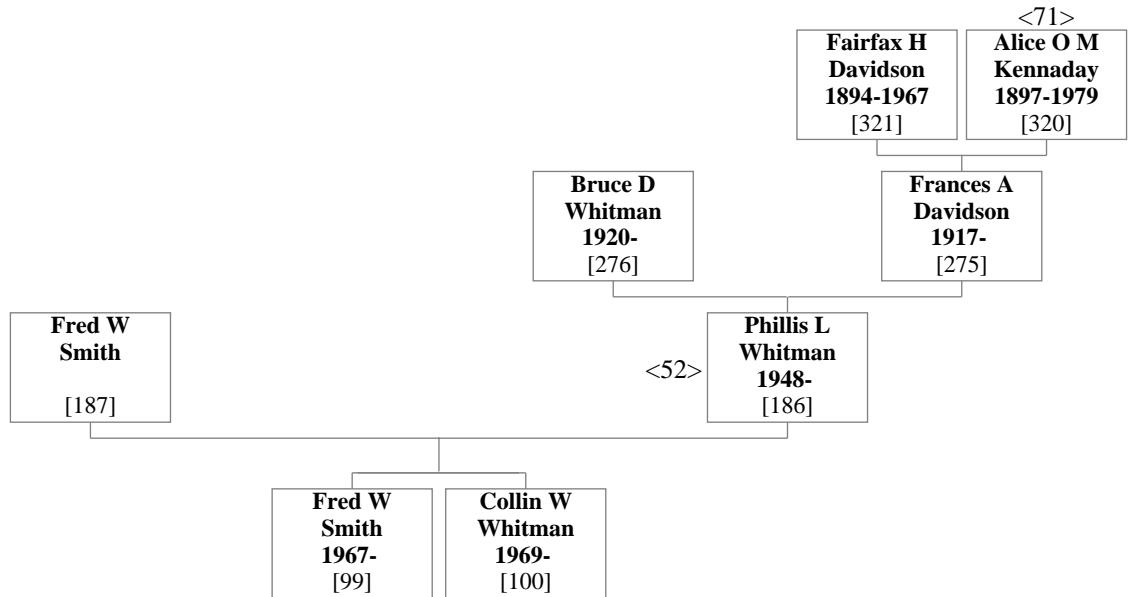

**36. Stanley Howard Self & Laurel Alice Whitman**

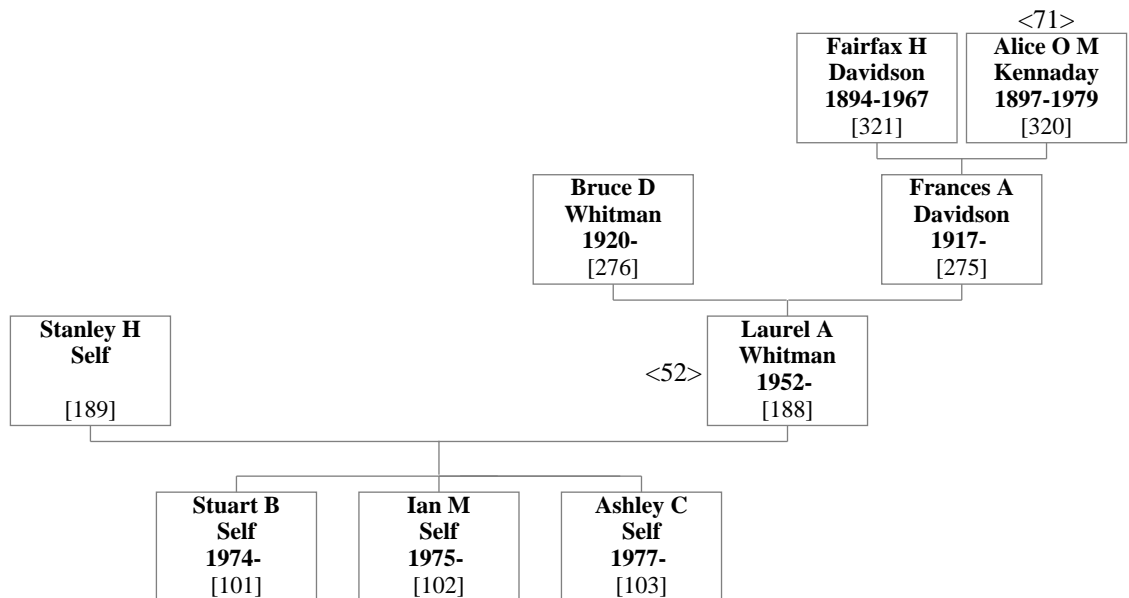

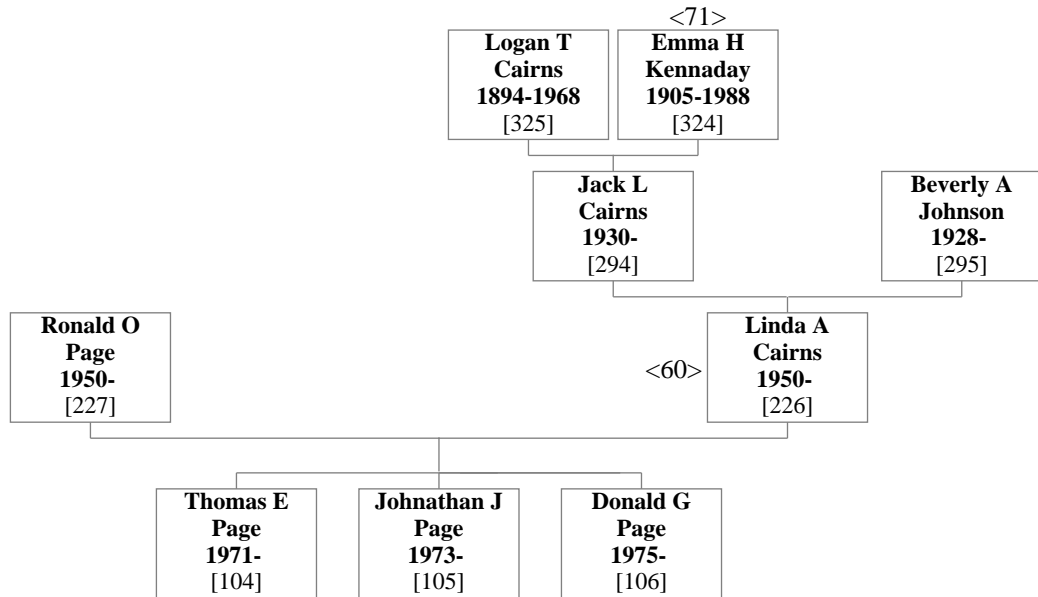
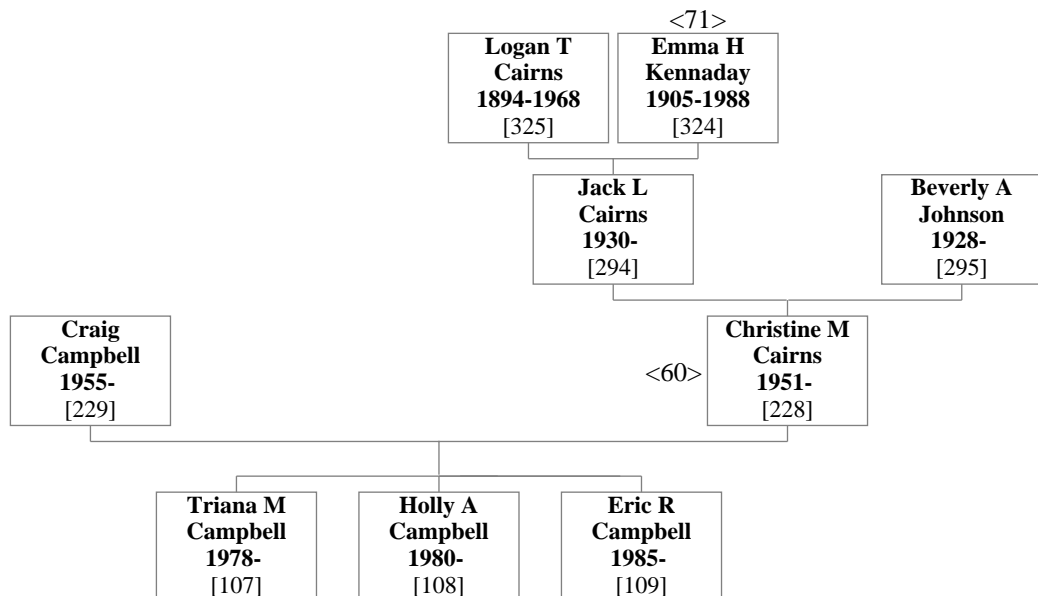
37. Ronald Otis Page & Linda Ann Cairns38. Craig Campbell & Christine Marie Cairns

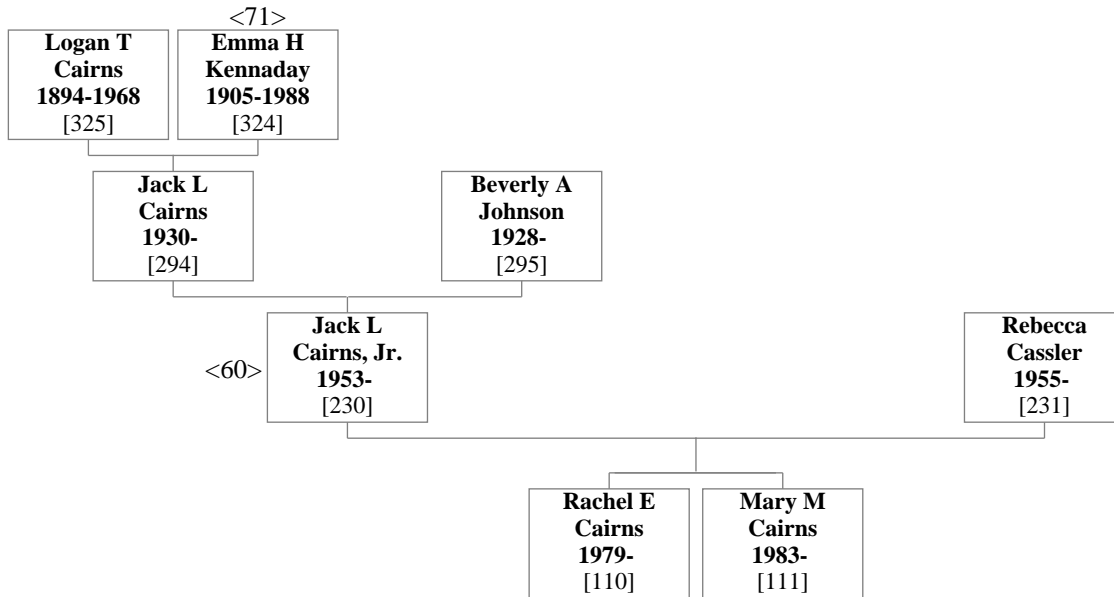
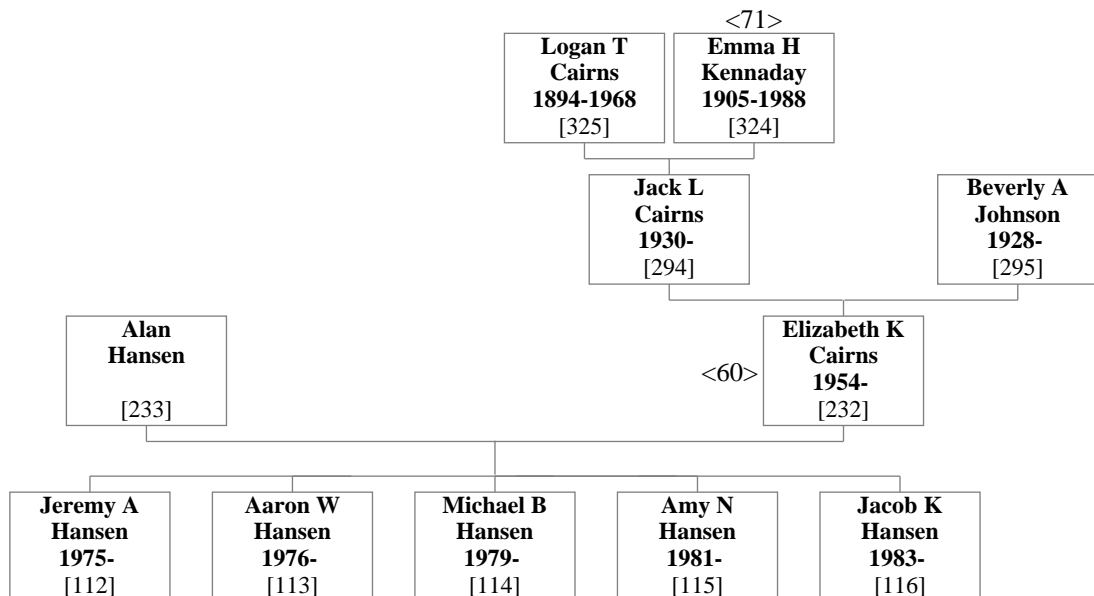
**39. Jack Lavoy Cairns, Jr. & Rebecca Cassler****40. Alan Hansen & Elizabeth Kay Cairns**

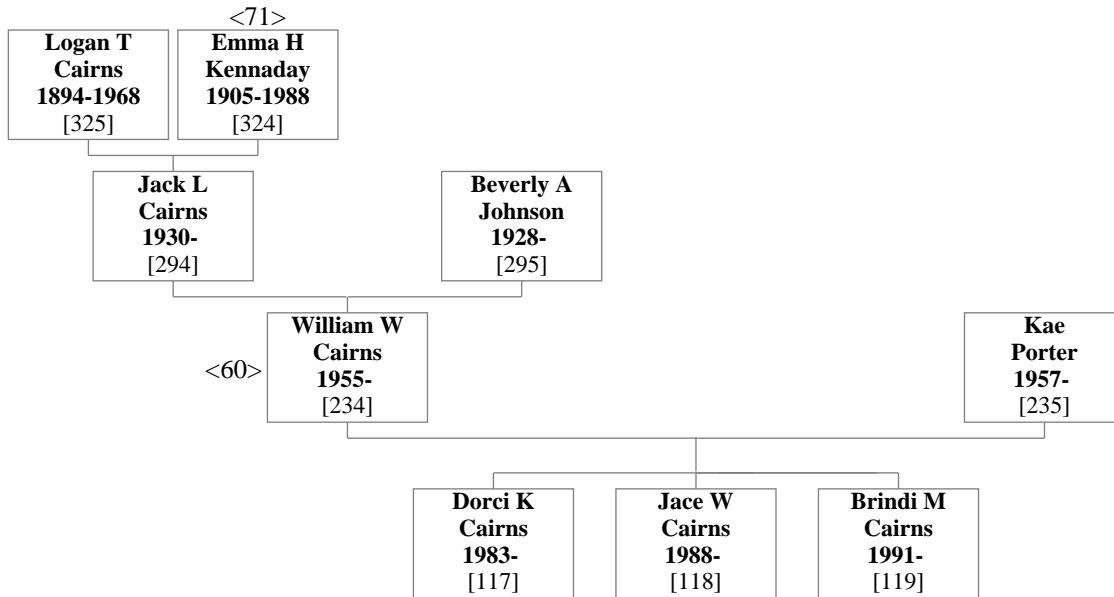
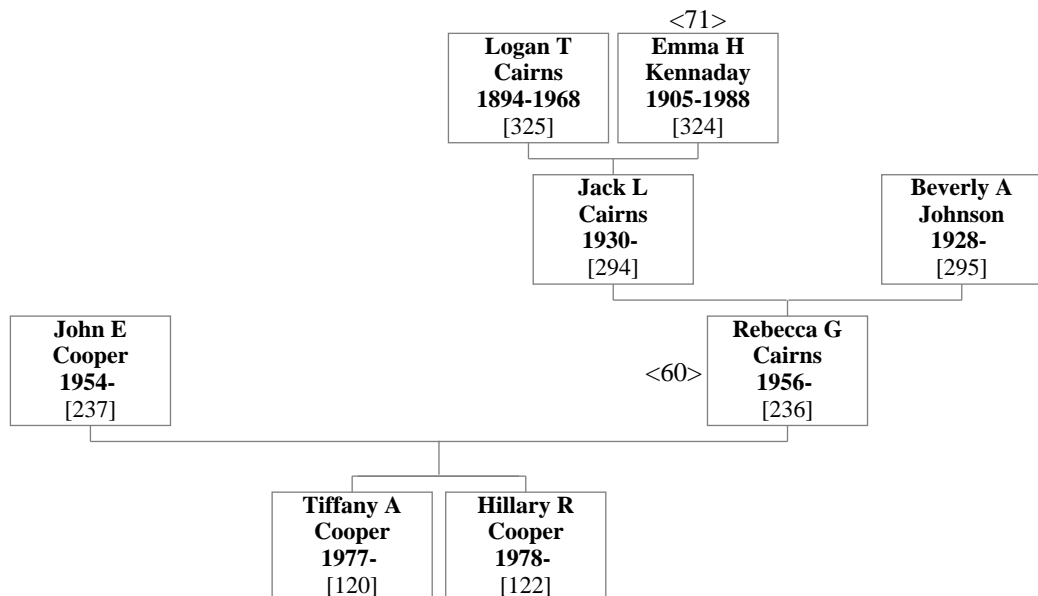
41. William Wayne Cairns & Kae Porter42. John Ellery Cooper & Rebecca Gay Cairns

**43. Carlie Jebens & Phyllis Ann Wilson**

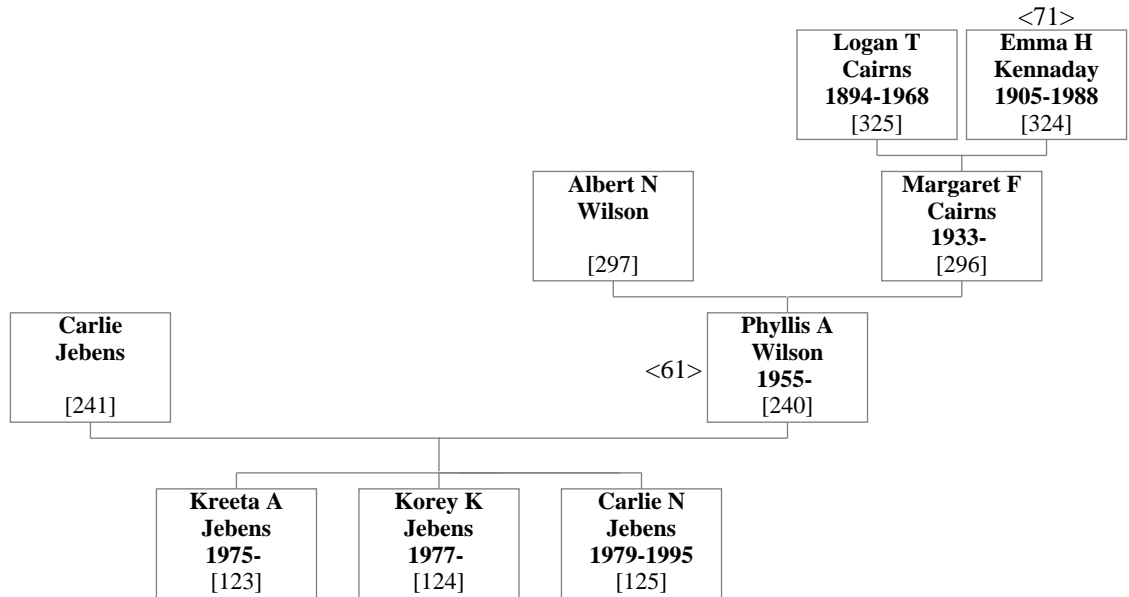

**44. Thomas Earl Kennaday & Gladys Eleanor Ream**

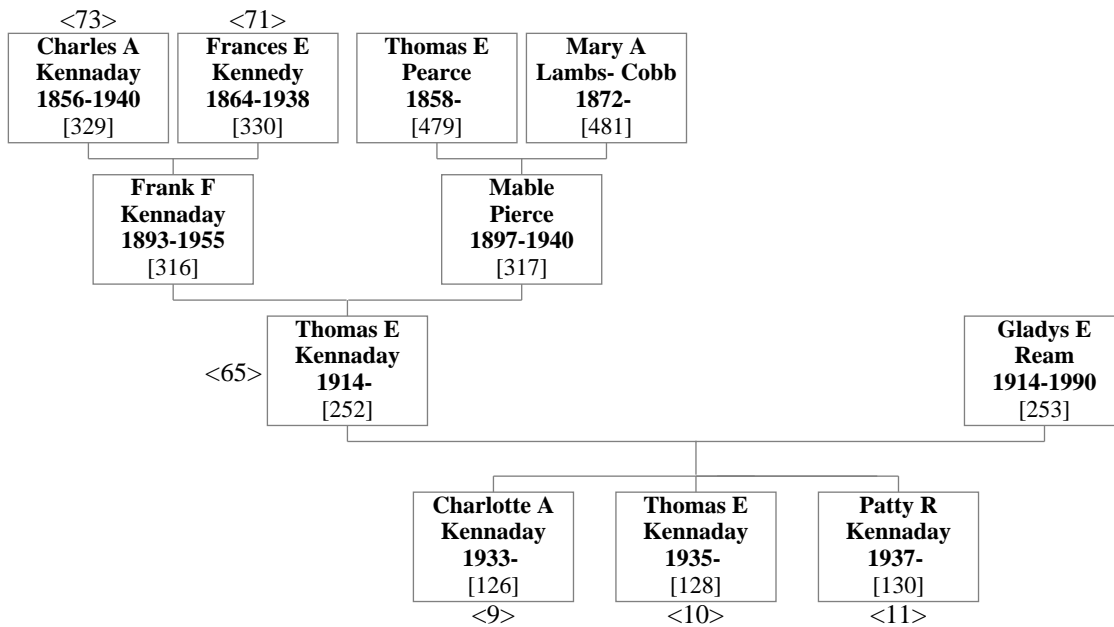

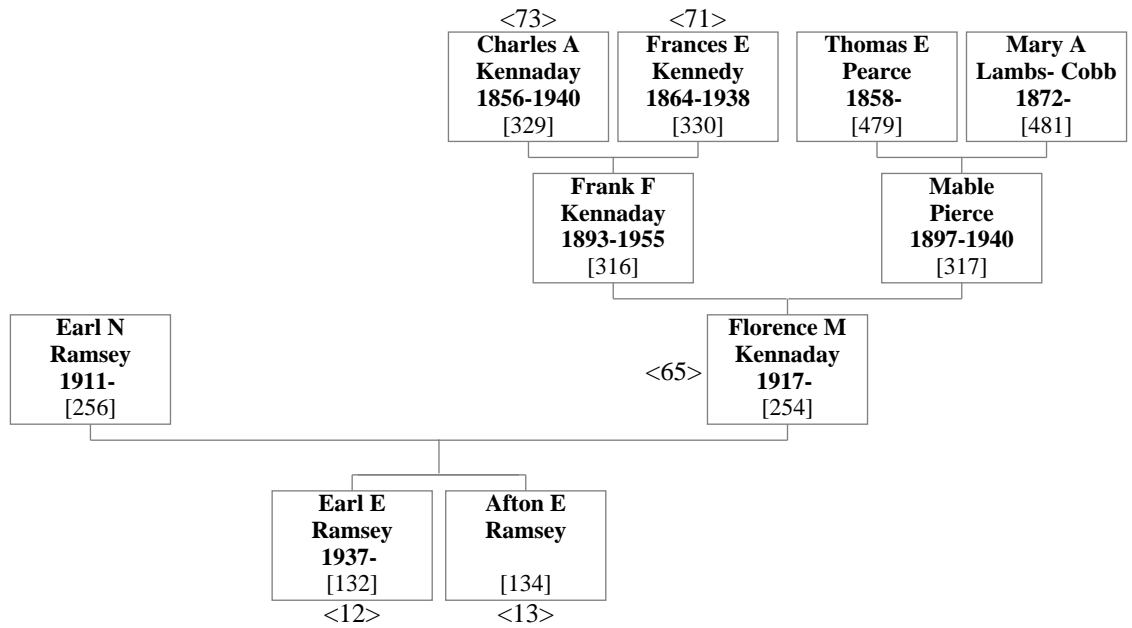
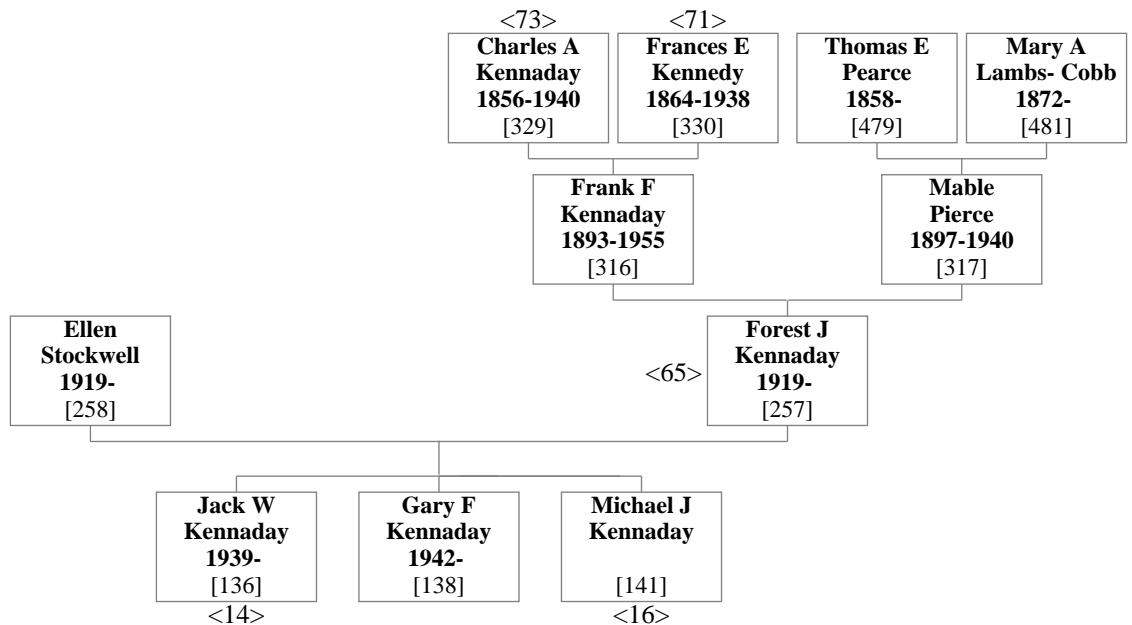
**45. Earl N Ramsey & Florence Mae Kennaday****46. Ellen (Dude) Stockwell & Forest Jack Kennaday**

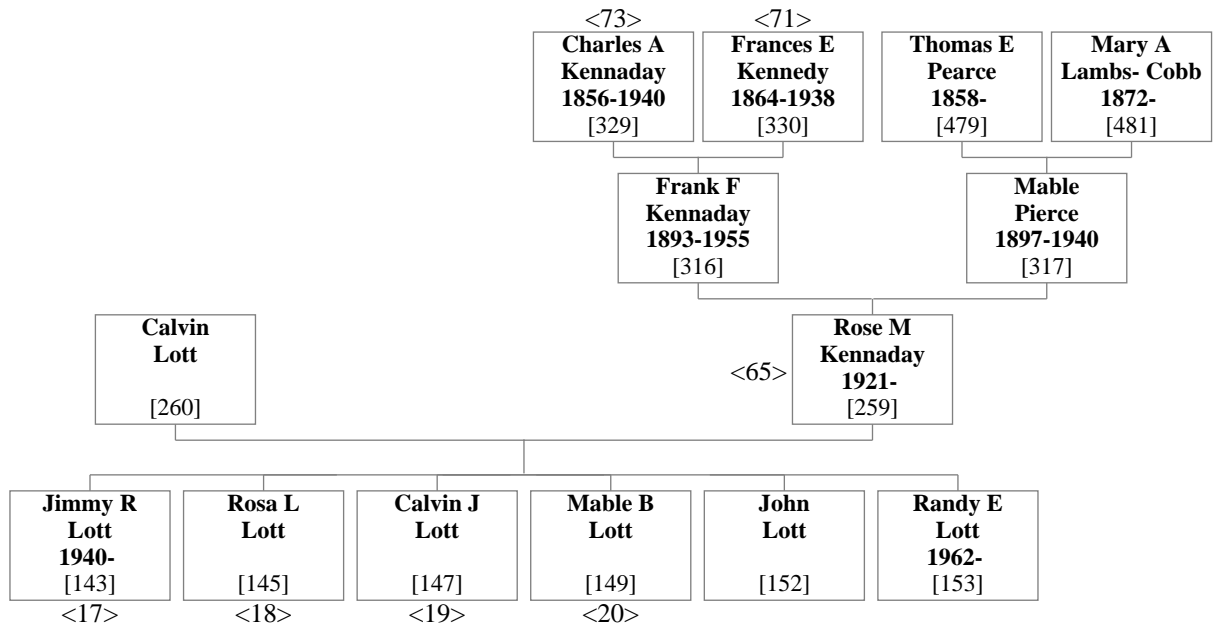
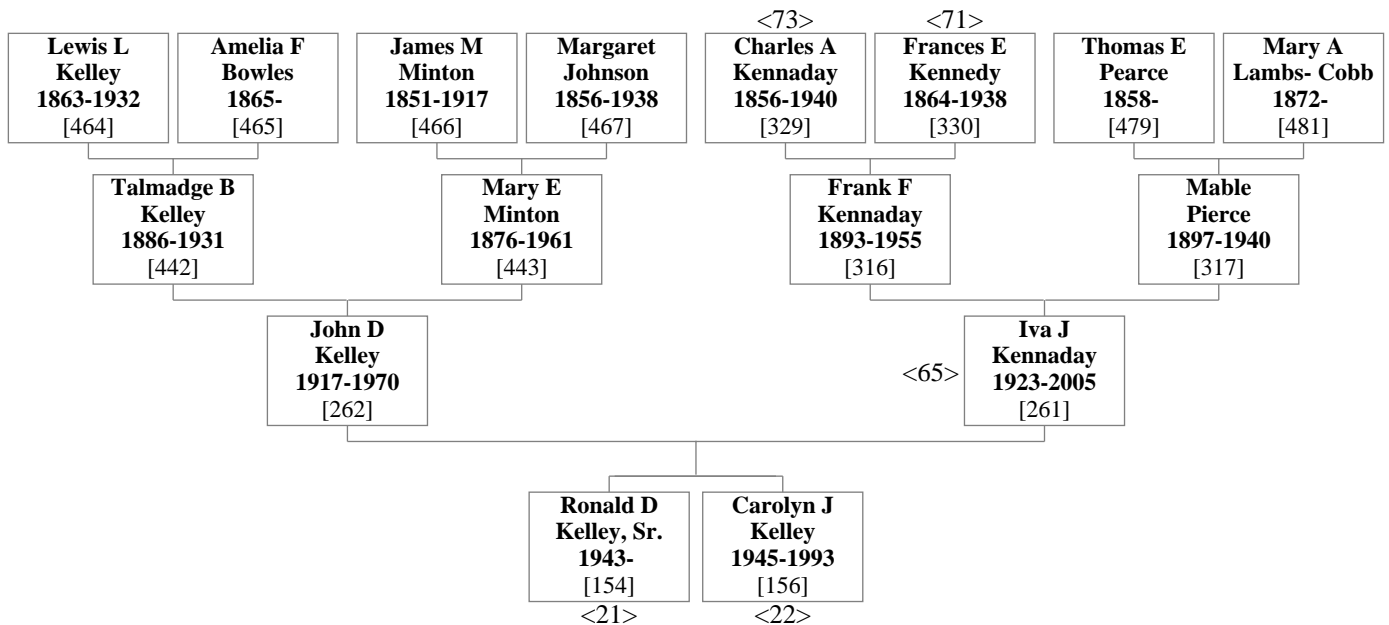
**47. Calvin Lott & Rose Marie Kennaday****48. John David Kelley & Iva June Kennaday**



**49. Gordon Johnson & Bonnie Jean Kennaday**

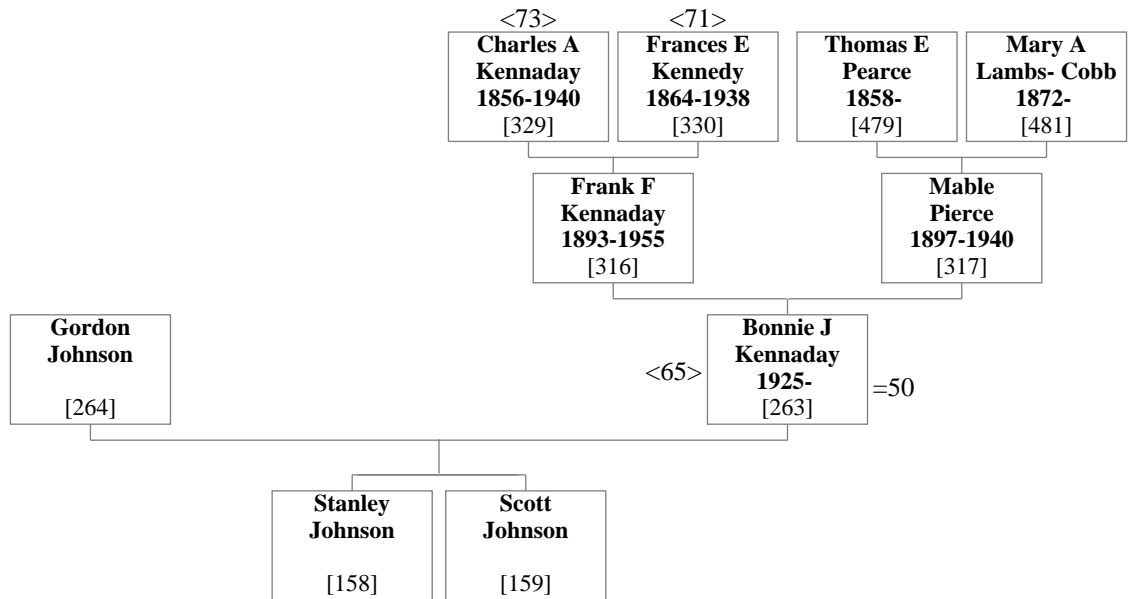

**50. James Martin Marier & Bonnie Jean Kennaday**

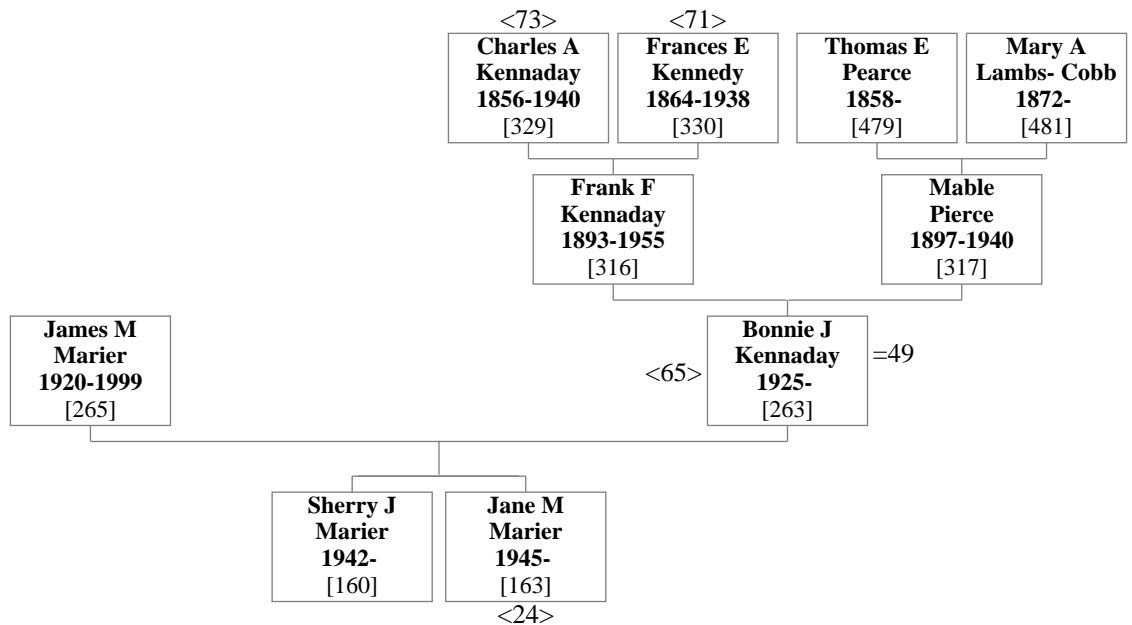

**51. Lincoln Frank Kennaday & Joan Olivia Debernardi**

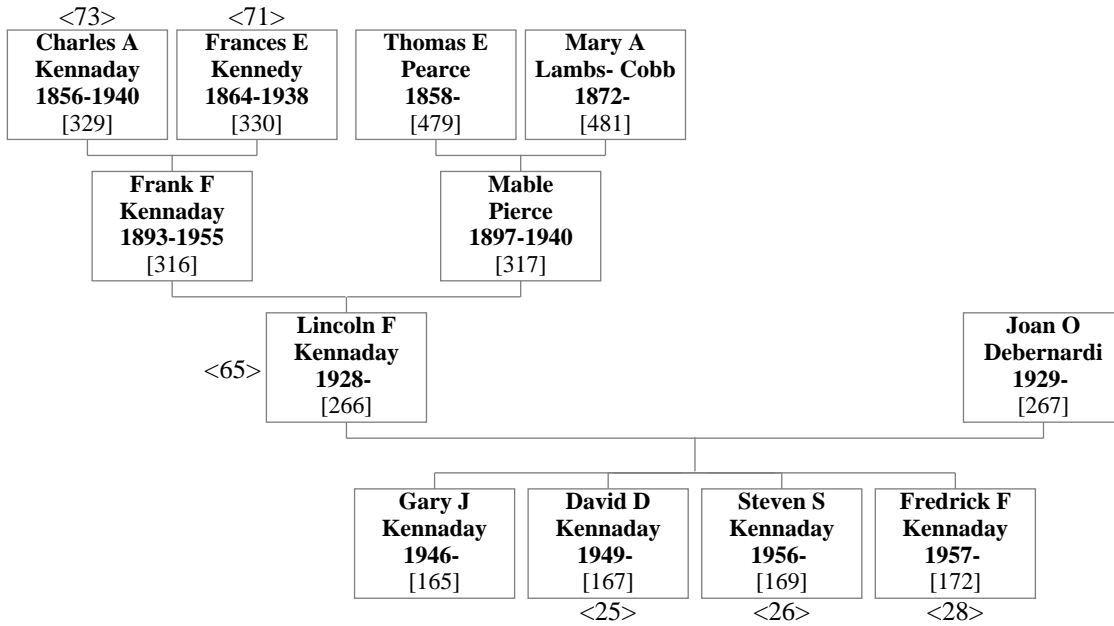

**52. Bruce Douglas Whitman & Frances Amonda Davidson**

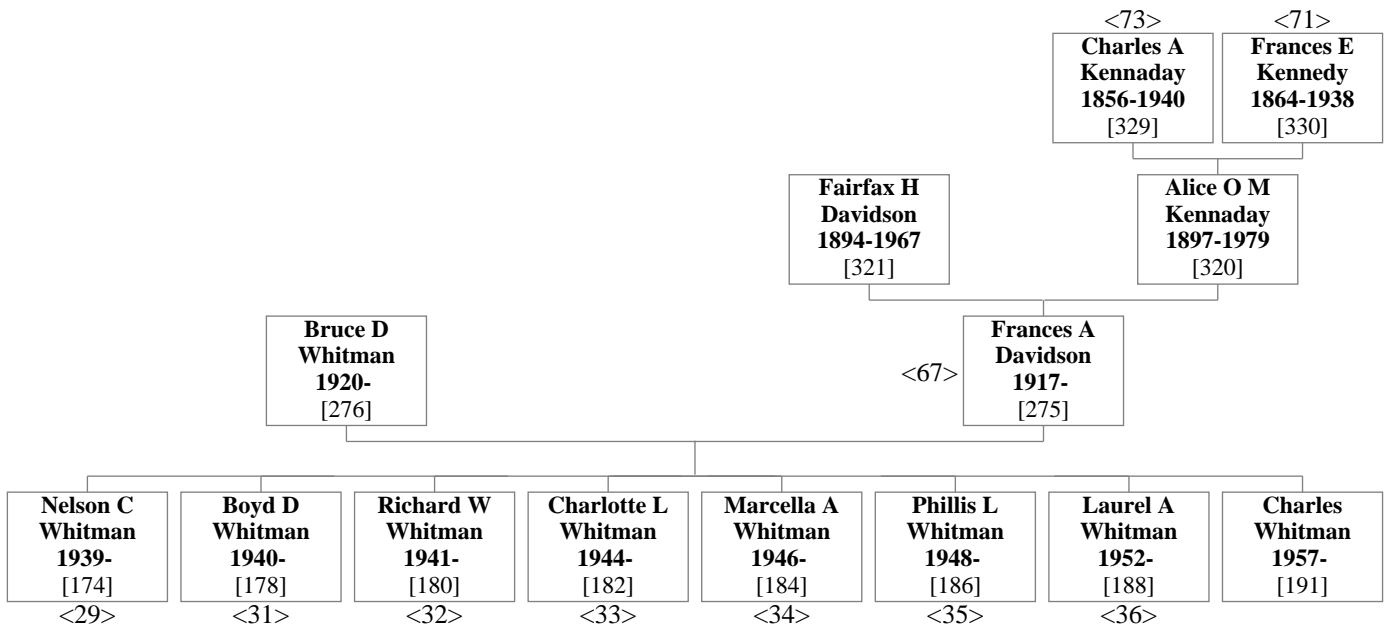

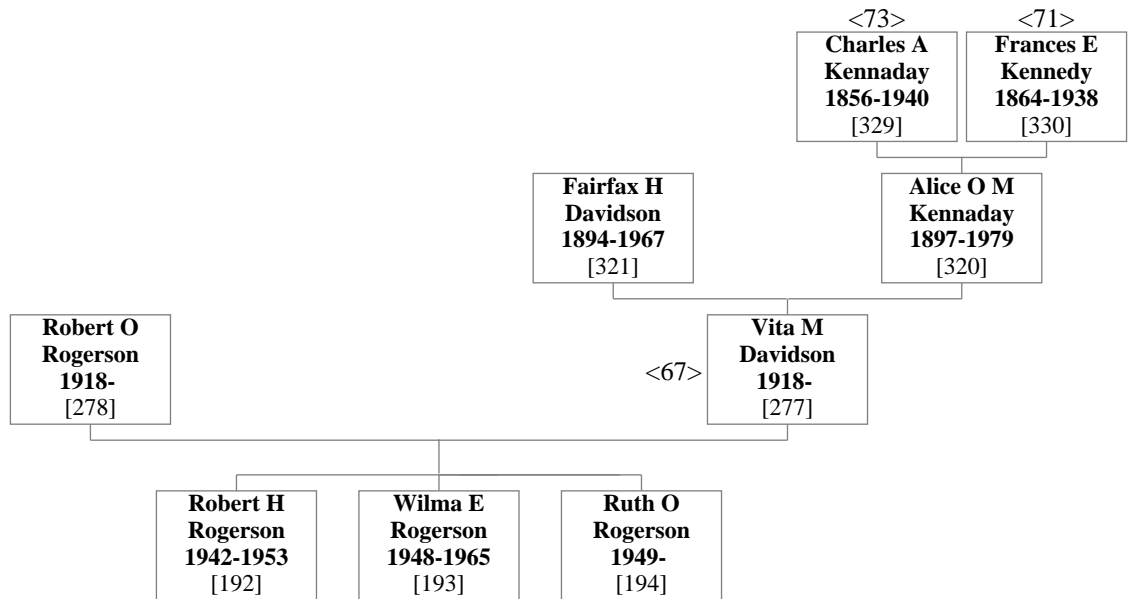
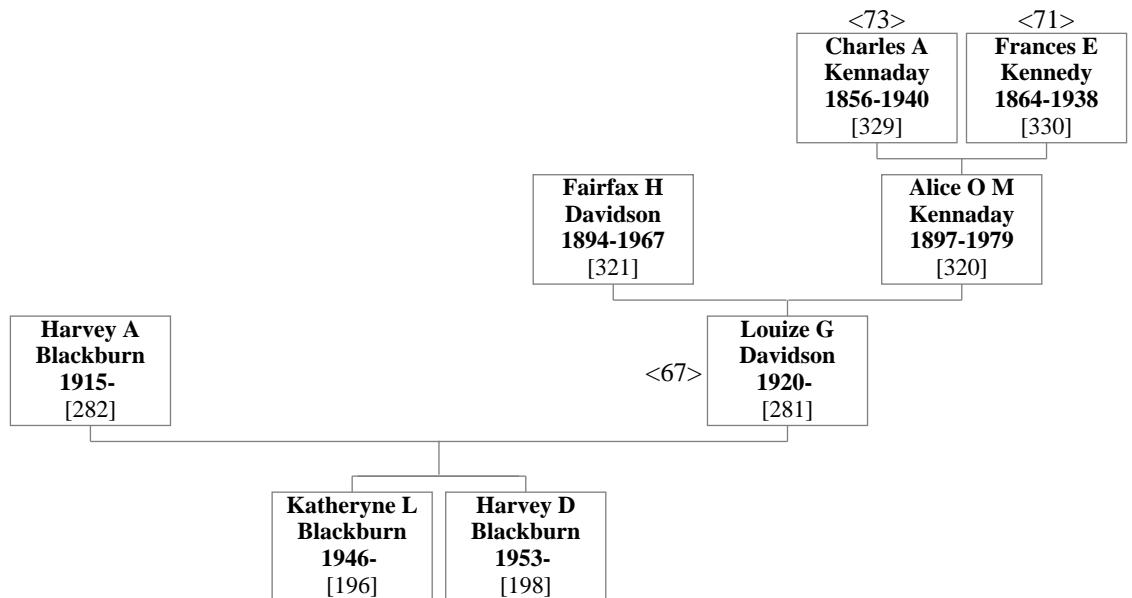
**53. Robert Orrin Rogerson & Vita Maude Davidson****54. Harvey Alton Blackburn & Louize Gertrude Davidson**

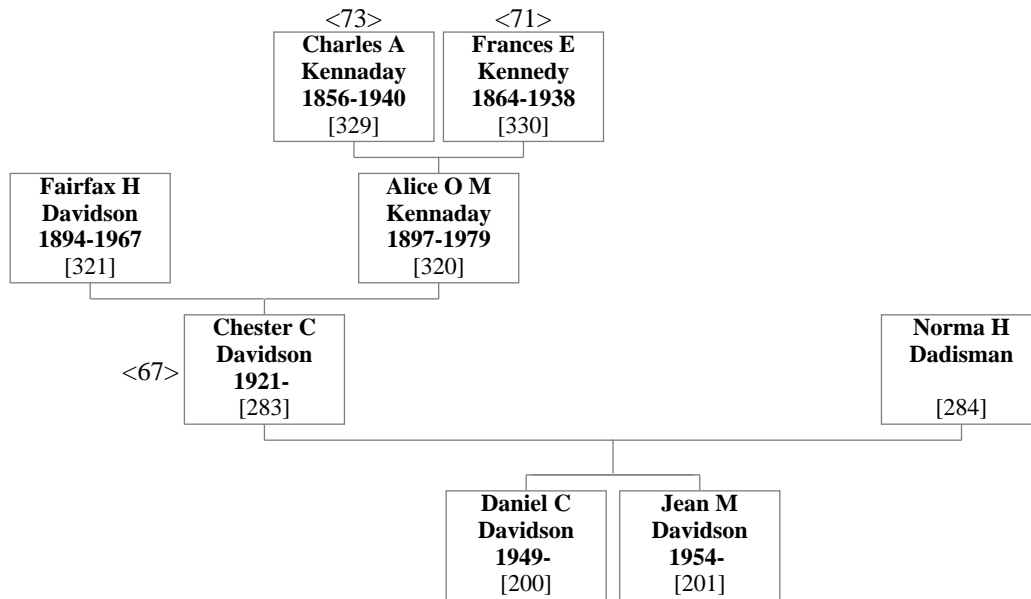
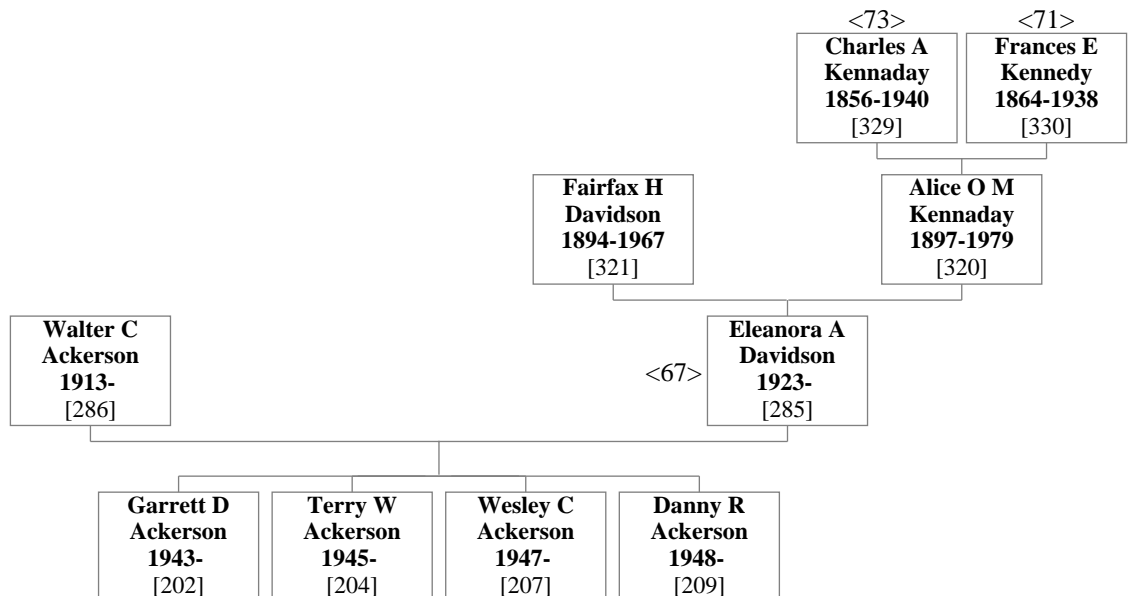
**55. Chester Clark Davidson & Norma Hilda Dadisman****56. Walter Cecil Ackerson & Eleanora Alice Davidson**

**57. Charles Daniel Davidson & Earlene Dee Noller**

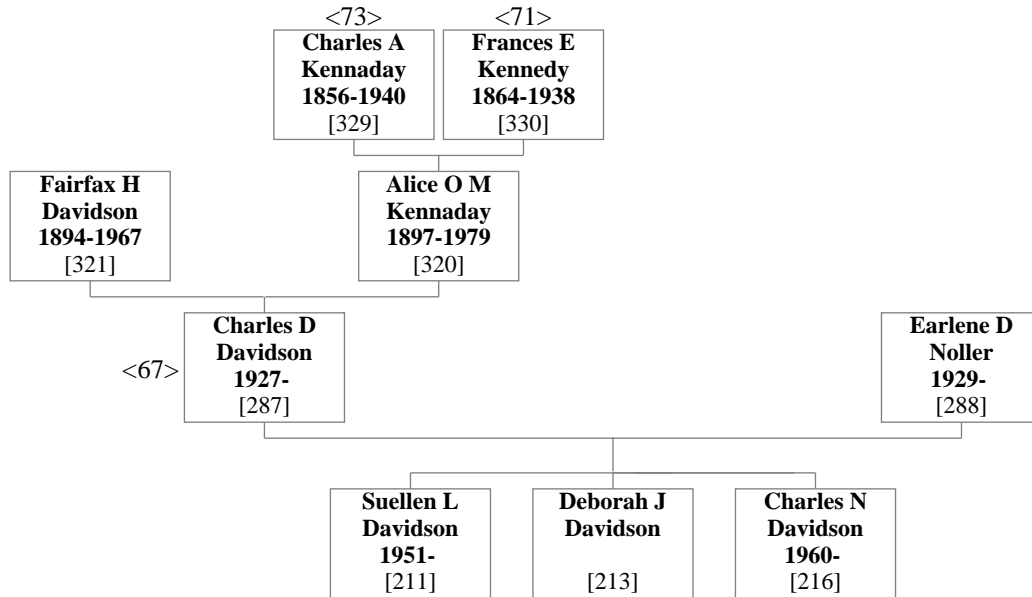

**58. David Debernardi Harned & Myrtle Rae Davidson**

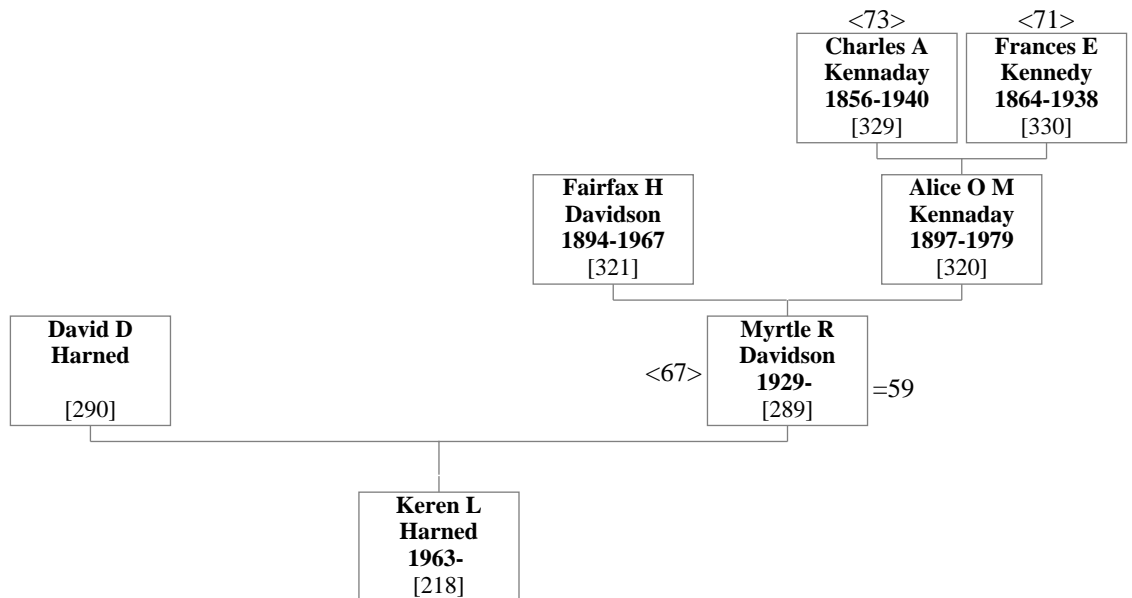

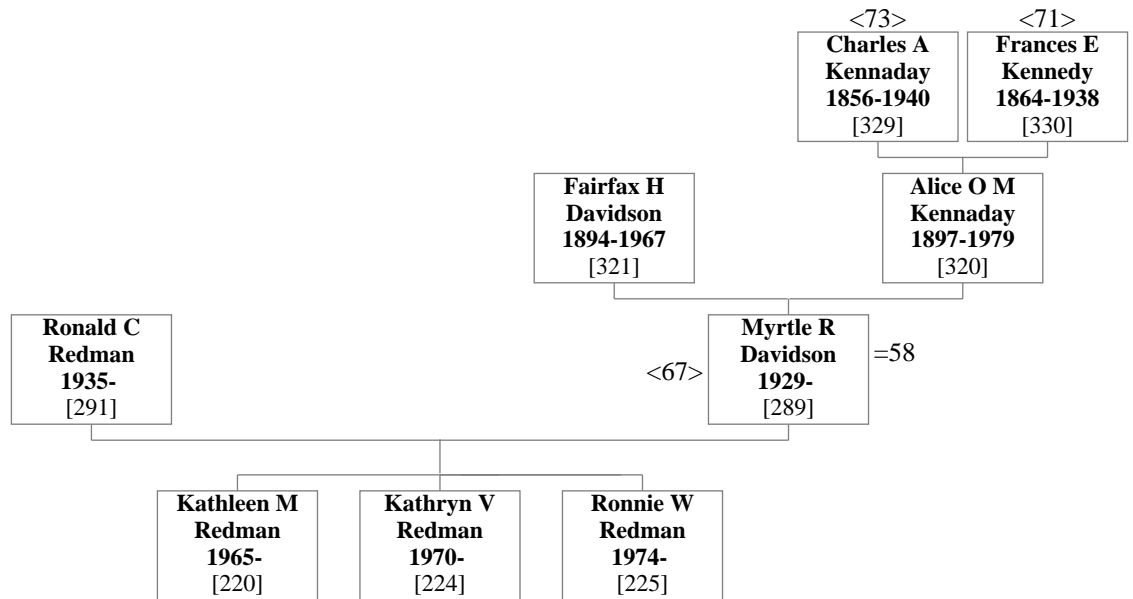
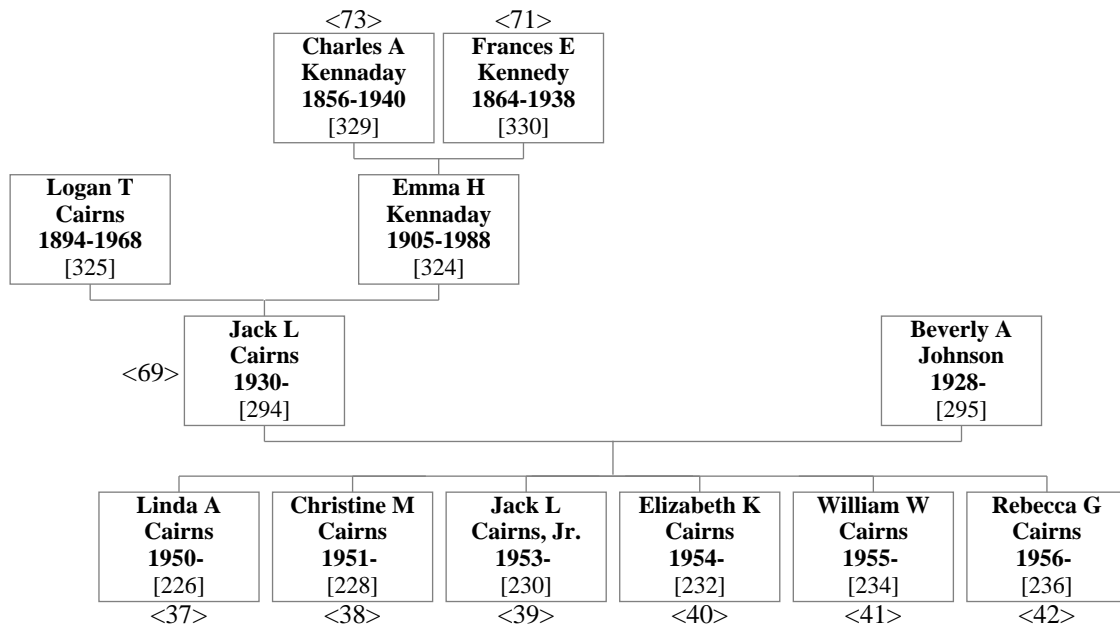
**59. Ronald Clark Redman & Myrtle Rae Davidson****60. Jack Lavoy Cairns & Beverly Ann Johnson**

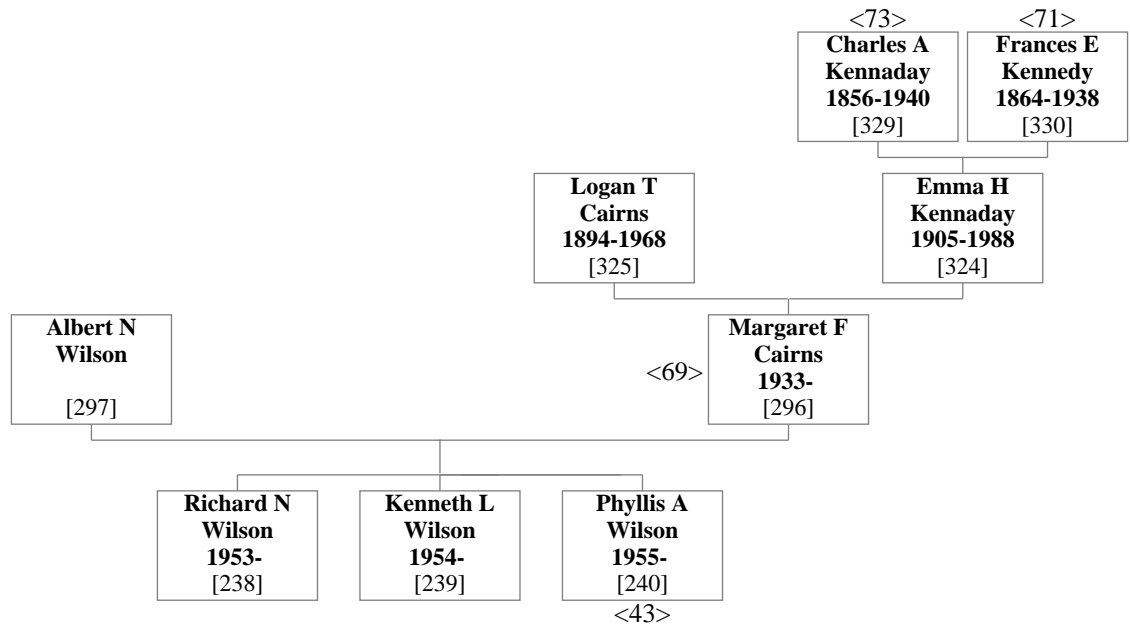
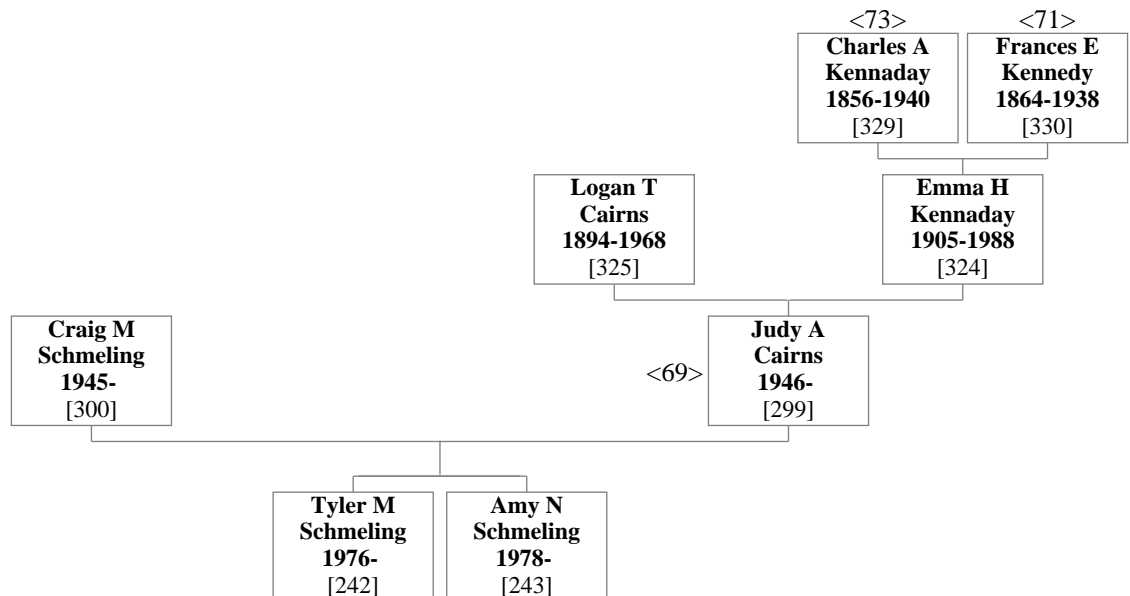
**61. Albert Norman Wilson & Margaret Faunita Cairns****62. Craig Martin Schmeling & Judy Ann Cairns**

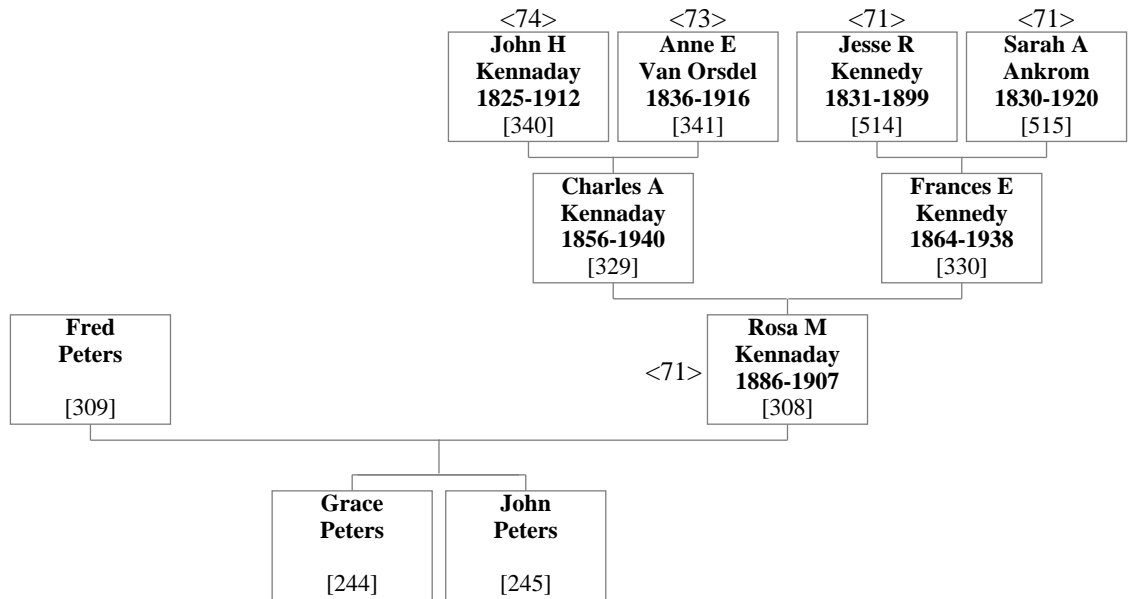
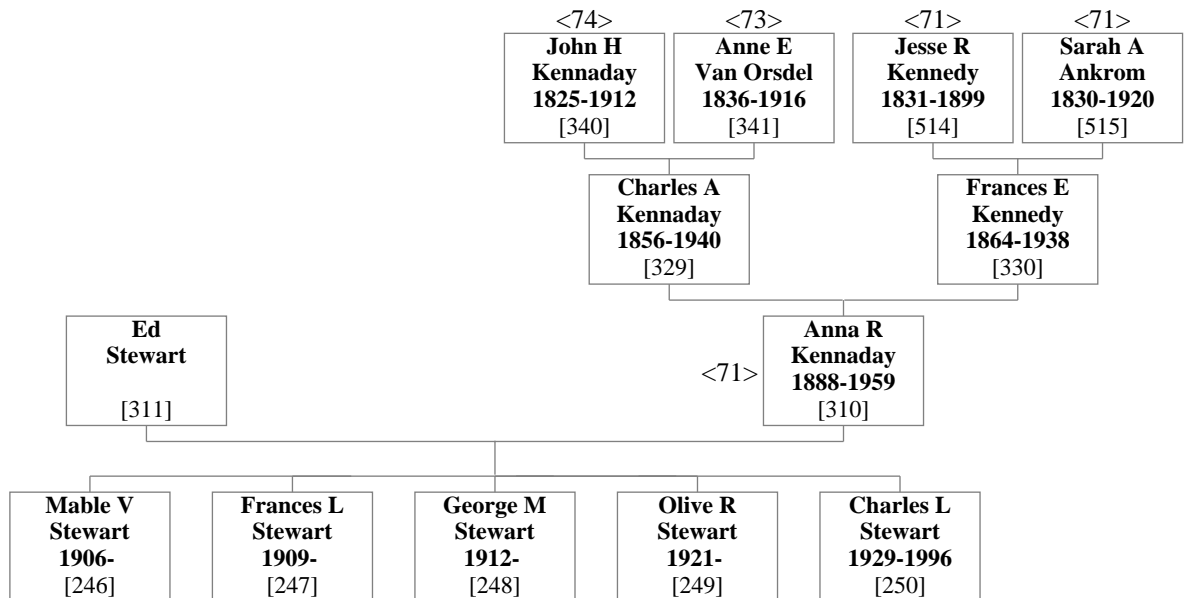
**63. Fred Peters & Rosa Marie Kennaday****64. Ed Stewart & Anna Ruth Kennaday**

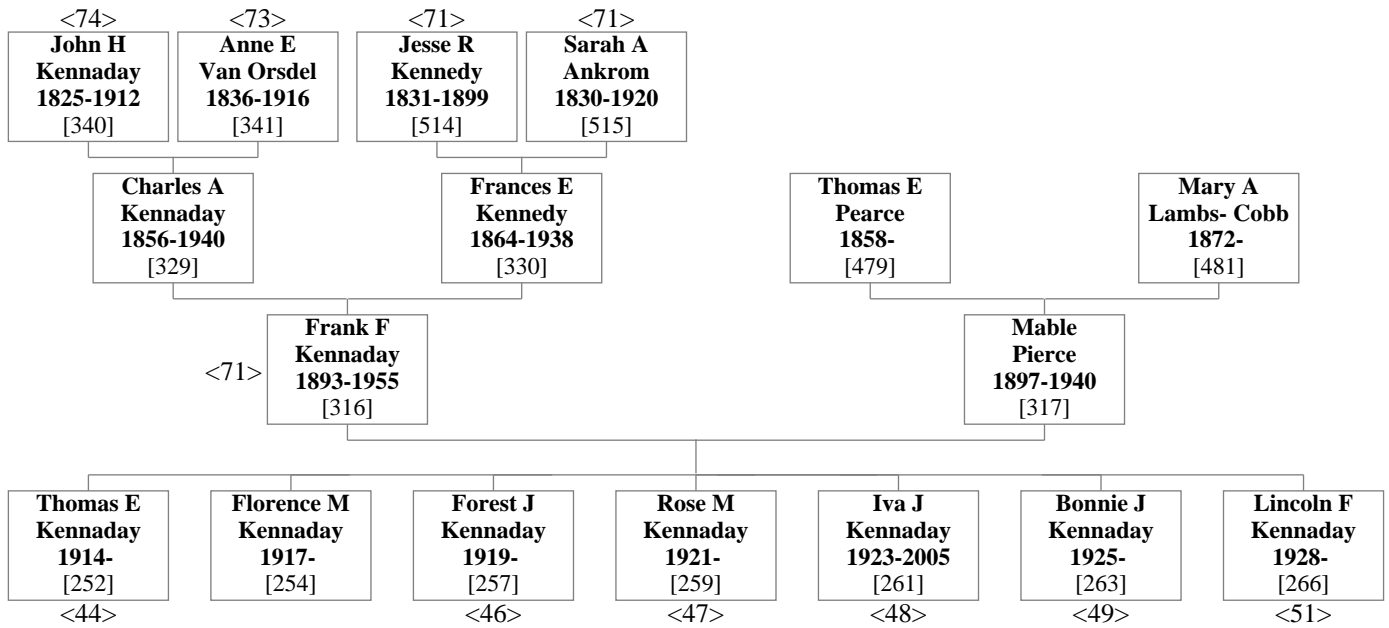
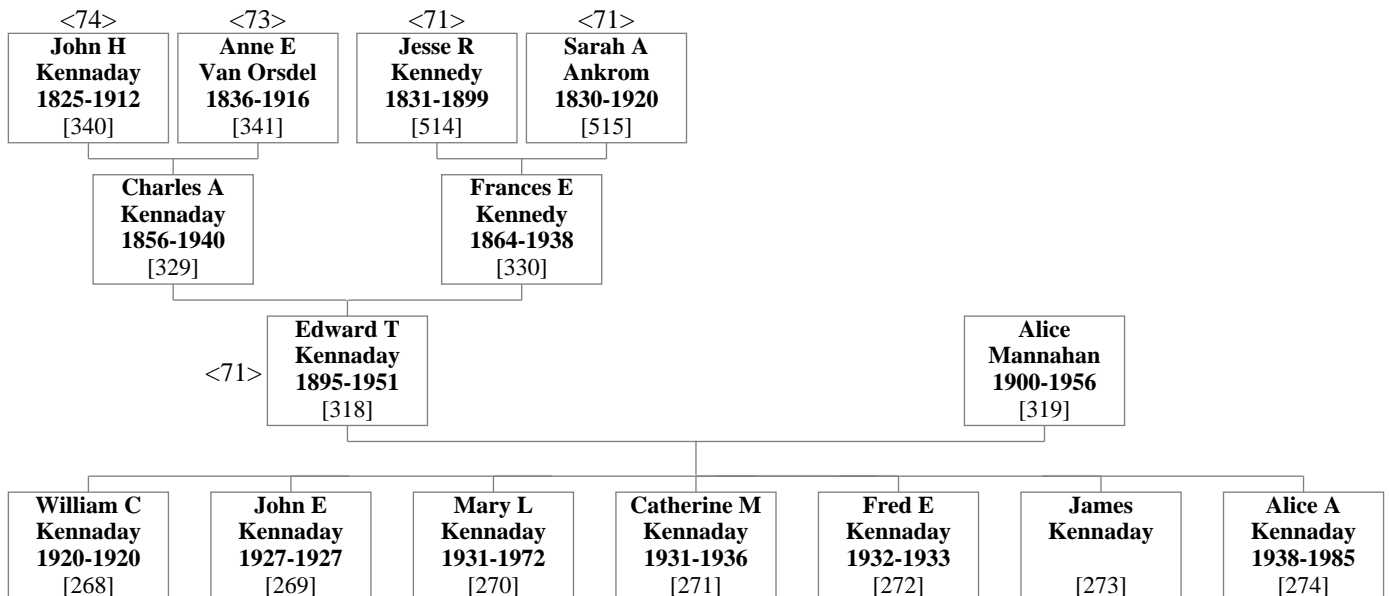

**65. Frank Forest Kennaday & Mable Pierce****66. Edward Thomas Kennaday & Alice Mannahan**

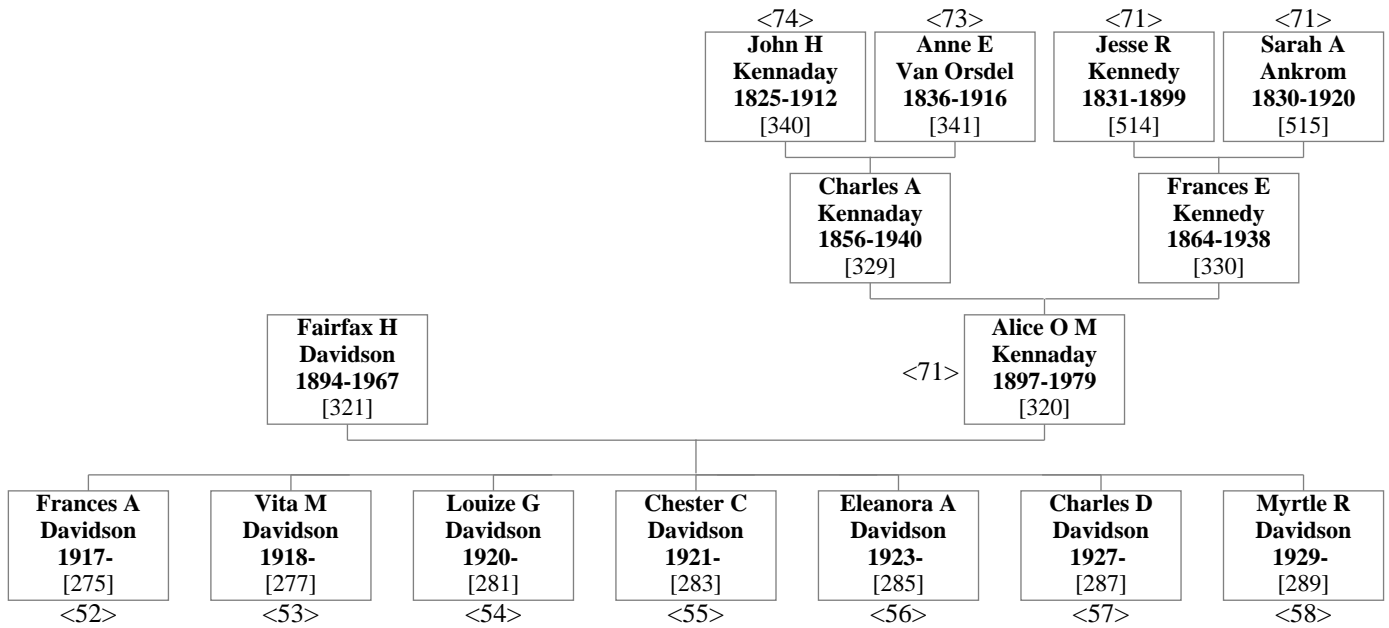
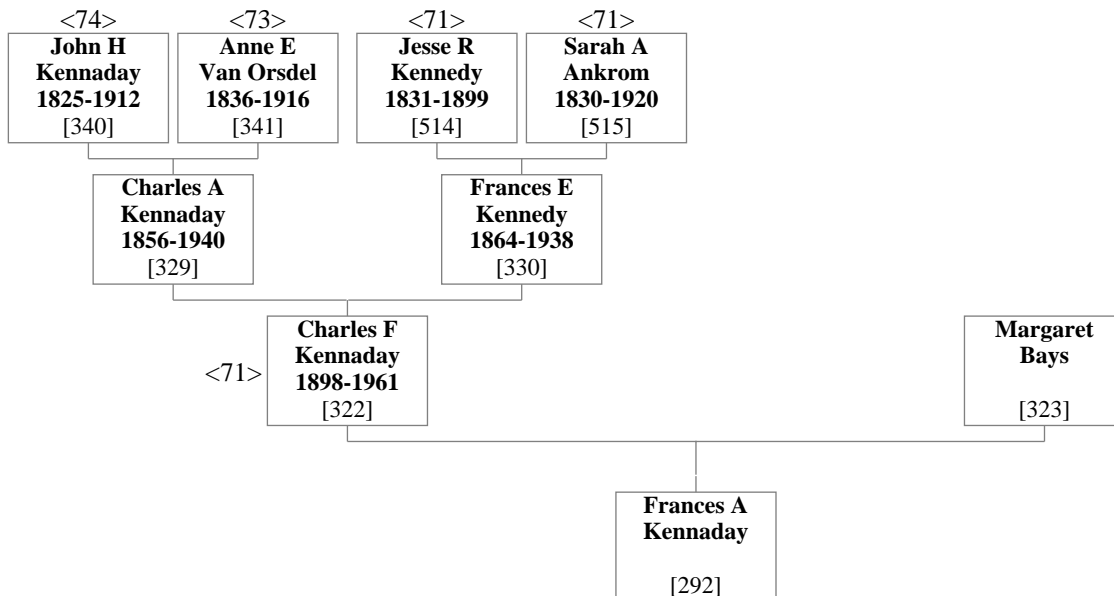
**67. Fairfax Harry Davidson & Alice Oda May Kennaday****68. Charles Fredrick Kennaday & Margaret Bays**

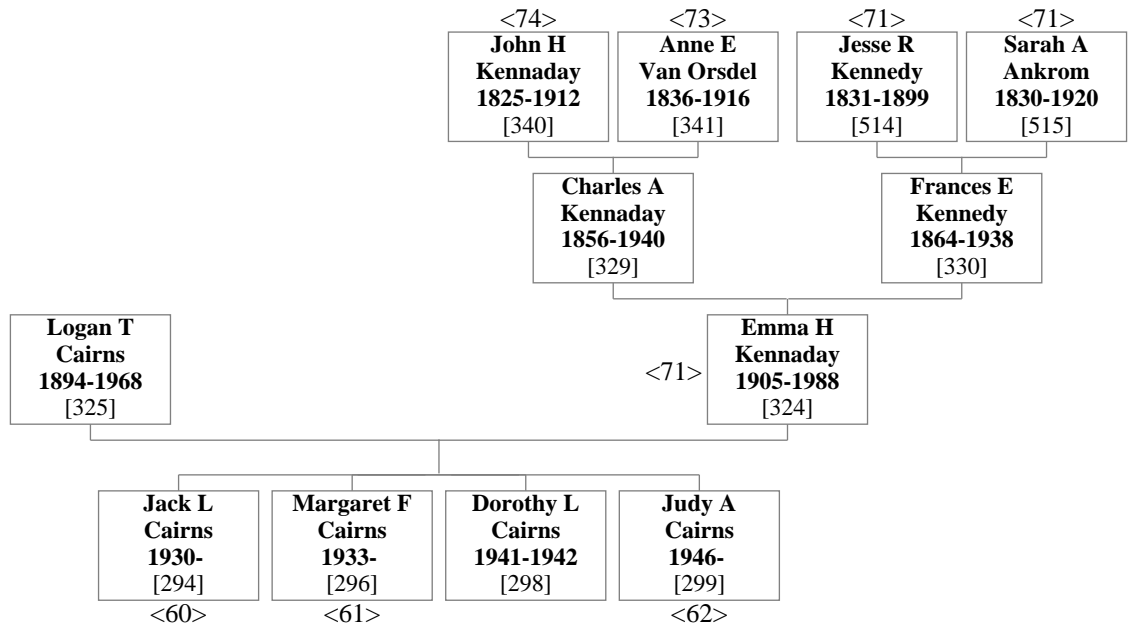
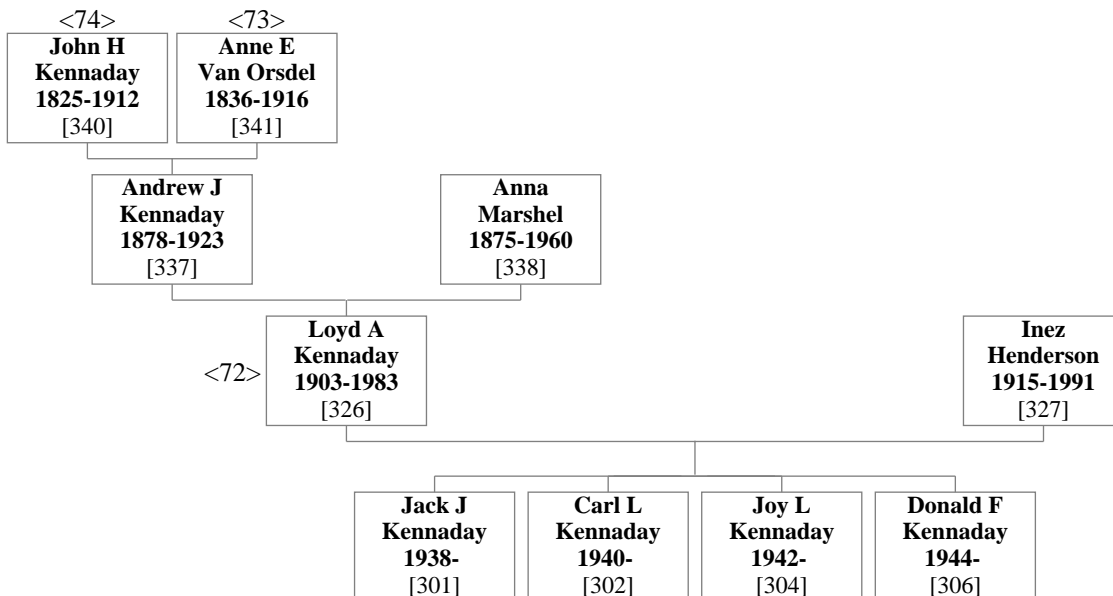
**69. Logan Turner Cairns & Emma Helen Kennaday****70. Loyd Andrew Kennaday & Inez Henderson**

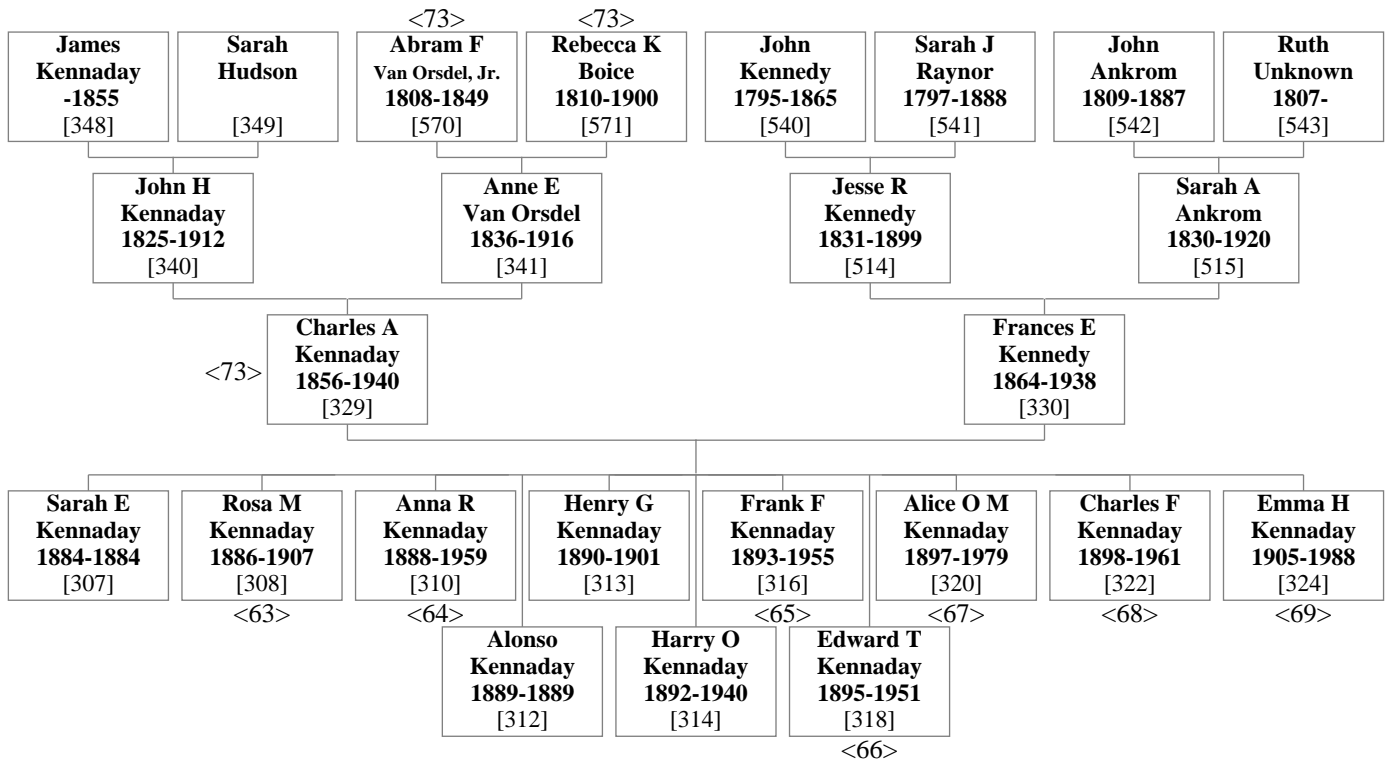
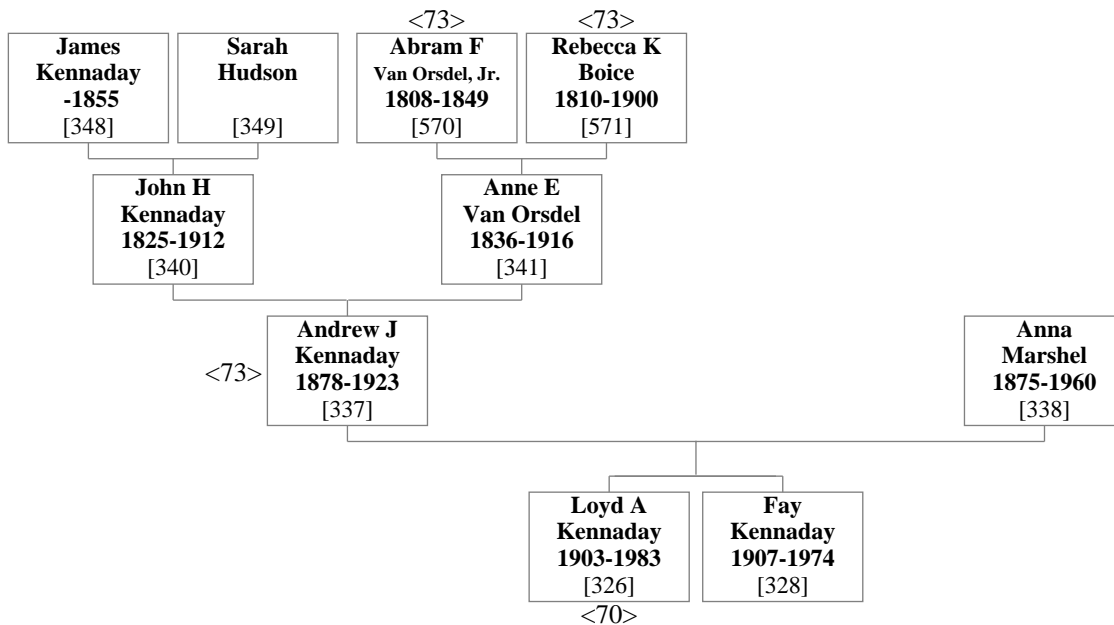
**71. Charles Alonzo Kennaday & Frances Elizabeth Kennedy****72. Andrew Jackson Kennaday & Anna Marshal**

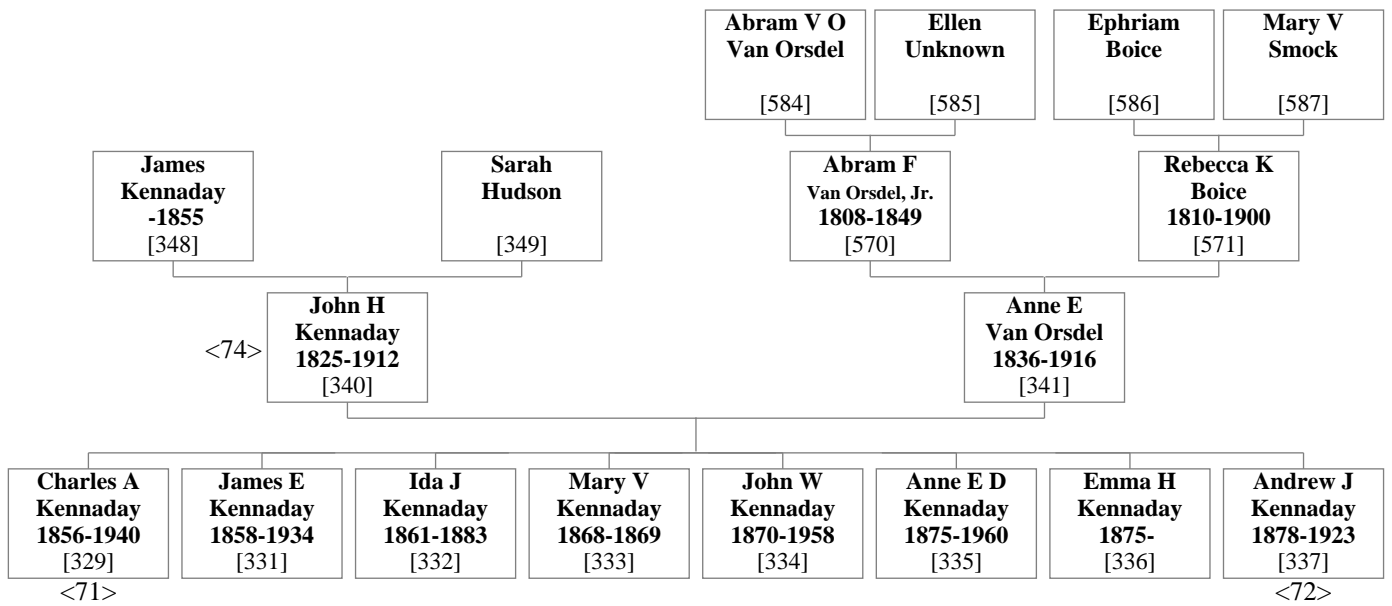
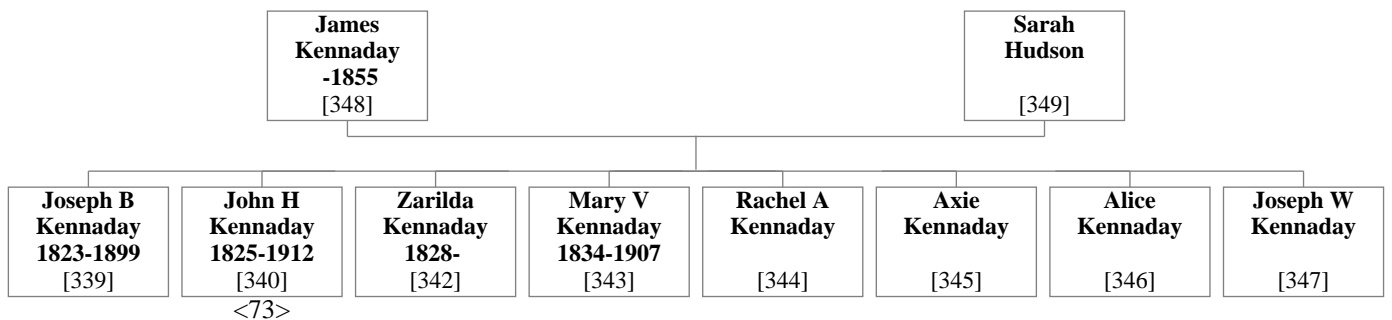
**73. John Hudson Kennaday & Anne Elizabeth Van Orsdel****74. James Kennaday & Sarah Hudson**

## 15. INDEX OF PLACES

### **1951**

Birth of Rita Dianne Rhoads<sup>166</sup>.

### **AD RICHEYS HOME IN MYERS STATION**

Death of Lewis Lute Kelley<sup>464</sup> on 25 July 1932.

### **CARLISLE KENTUCKY, CARLISLE CEMETARY**

Burial of John David Kelley<sup>262</sup>.

### **COLORADO, DENVER**

Marriage of Thomas Earl Pearce<sup>479</sup> and Mary Adele Lambs- Cobb<sup>481</sup>.

Birth of Alice Pearce<sup>477</sup> on 28 December 1893.

Birth of Mable Pierce<sup>317</sup> on 5 January 1897.

### **CREMATION: ASHES ON GRAVE OF MELONY JO CURTIS DAUGHTER**

Burial of Carolyn June Kelley<sup>156</sup>.

### **ENGLAND, LONDON**

Birth of James Phipps<sup>480</sup>.

Birth of Thomas Earl Pearce<sup>479</sup> on 6 June 1858.

### **ILLINOIS, MACON, BOODY**

Birth of James Franklin Kennedy<sup>507</sup> on 15 November 1866.

Birth of William Edson Kennedy<sup>509</sup> on 15 October 1868.

### **INDIANA, INDIANAPOLIS, WASHINGTON PARK CEMETERY**

Burial of Ronald David Kelley, Jr.<sup>58</sup>.

### **IRELAND, DUBLIN**

Birth of James Kennaday<sup>348</sup>.

Birth of John Kennedy<sup>540</sup> on 9 January 1795.

### **KENNADAY RANCH**

Burial of Anne Elizabeth Van Orsdel<sup>341</sup>.

### **KENTUCKY, BRETTHETT**

Birth of Millard Gulett<sup>377</sup> on 11 August 1883.

### **KENTUCKY, CARLISLE, CARLISLE CEMETARY**

Burial of Iva June Kennaday<sup>261</sup>.

### **KENTUCKY, CARLISLE, CEMETERY, CARLISLE**

Burial of Melony Jo Curtis<sup>69</sup>.

### **KENTUCKY, COUNTY, NICHLOS**

Birth of Lewis Lute Kelley<sup>464</sup> on 5 February 1863.

### **KENTUCKY, VANDERVILL**

Birth of Talmadge Blane Kelley<sup>442</sup> on 12 July 1886.

### **MISSOURI, MACON**

Birth of Mary Adele Lambs- Cobb<sup>481</sup> on 24 September 1872.

### **NICARAQUA, MANAQUA**

Birth of Caitlin Arlena Boyd<sup>1</sup> in 1992.

### **NOBEL**

Marriage of Jonn Kennedy<sup>522</sup> and Lydia Jarvis<sup>523</sup> on 6 October 1861.

**OHIO**

Marriage of Jesse Rufus Kennedy<sup>514</sup> and Sarah Ann Ankrom<sup>515</sup> on 11 December 1851.

**OREGON**

Birth of Todd Kennaday<sup>33</sup> on 5 May 1960.

**PENNSYLVANIA USA, GREEN, WAYNESBURG**

Birth of Sarah Jane Raynor<sup>541</sup> on 10 October 1797.

Birth of James Leighton Kennedy<sup>520</sup> on 10 November 1826.

**PENNSYLVANIA USA, GREEN, WANYNESBURG**

Birth of Jacob Kennedy<sup>519</sup> on 10 November 1826.

**TENNESSE**

Birth of Cristian Hunnicutt<sup>53</sup>.

**TENNESSEE**

Marriage of James M Minton<sup>466</sup> and Margaret Johnson<sup>467</sup>.

**TEXAS, ANTONIO**

Marriage of Thomas Eugene Kennaday<sup>128</sup> and Janice Benson<sup>129</sup> in 1960.

**USA AT CHURCH OF CRIST, KANSAS, CHAUQUA, CEDARVALE**

Marriage of Charles Alonzo Kennaday<sup>329</sup> and Frances Elizabeth Kennedy<sup>330</sup> on 11 November 1883.

**USA, ALABAMA, HUNTSVILLE**

Birth of Donna Denice Thompson<sup>361</sup> on 6 January 1964.

Death of Donna Denice Thompson<sup>361</sup> on 18 February 1964.

**USA, ARIZONA, ORANGE, PHOENIX**

Birth of Joyce Ellen Jorgensen<sup>34</sup> in 1962.

**USA, CALIFORNIA, HUMBOLDT, BLUE LAKE**

Birth of Olive Ruth Stewart<sup>249</sup> in 1921.

Birth of Charles Leroy Stewart<sup>250</sup> in 1929.

**USA, CALIFORNIA, ORANGE, ANAHEIM**

Birth of Adam Malaki Kennaday<sup>7</sup> in 1987.

Birth of Aaron Forest Kennaday<sup>8</sup> in 1990.

**USA, CALIFORNIA, NAPA, VALLEJO**

Birth of Karla Lynn Kennaday<sup>26</sup> on 8 July 1961.

Birth of Kathy Kay Kennaday<sup>27</sup> in 1962.

**USA, CALIFORNIA, LOS ANGELES, BURBANK**

Birth of Brigid Ann Young<sup>173</sup> in 1956.

**USA, CALIFORNIA, SAN DIAGO, SAN DIAGO**

Birth of Patricia Leigh Kennaday<sup>80</sup> in 1979.

**USA, CALIFORNIA, VAN NUYS**

Birth of Catherine Susan Lavelle<sup>170</sup> in 1956.

**USA, CHEROKEE NATION**

Birth of Mary V Kennaday<sup>333</sup> on 12 January 1868.

**USA, COLORADO, ADAMS, DENVER**

Birth of Frances Amonda Davidson<sup>275</sup> in 1917.

**USA, COLORADO, DENVER, DENVER**

Marriage of Logan Turner Cairns<sup>325</sup> and Emma Helen Kennaday<sup>324</sup> on 3 December 1925.

**USA, COLORADO, ELPASO, COLORADO SPRINGS**

Birth of Ronald Otis Page<sup>227</sup> in 1950.

**USA, COLORADO, MOFFAT, CRAIG**

Birth of Jeremy Alan Hansen<sup>112</sup> in 1975.

**USA, COLORADO, PUEBLO**

Birth of Ronald David Kelley, Sr.<sup>154</sup> on 10 September 1943.

**USA, COLORADO, SUPERIOR**

Birth of Gladys Eleanor Ream<sup>253</sup> in 1914.

**USA, FLORIDA, PASCO, HOLIDAY**

Death of Virginia Ruth Gullett<sup>374</sup> on 21 January 2007.

**USA, IDAHO, BONNEVILLE, IDAHO FALLS**

Birth of Aaron Wayne Hansen<sup>113</sup> in 1976.

Birth of Michael Brent Hansen<sup>114</sup> in 1979.

Birth of Amy Nicole Hansen<sup>115</sup> in 1981.

Birth of Dorci Kae Cairns<sup>117</sup> in 1983.

Birth of Jacob Karl Hansen<sup>116</sup> in 1983.

Birth of Jace William Cairns<sup>118</sup> in 1988.

Birth of Brindi Michelle Cairns<sup>119</sup> in 1991.

**USA, ILLINOIS, MCLEAN, LEXINGTON**

Birth of James Edward Kennaday<sup>331</sup> on 15 July 1858.

Birth of Ida Jane Kennaday<sup>332</sup> on 4 April 1861.

Birth of Anne E D Kennaday<sup>335</sup> on 29 April 1875.

**USA, INDIANA, INDIANAPOLIS**

Marriage of Cristian Hunnicutt<sup>53</sup> and Lisa June Kelley<sup>52</sup> on 13 February 1982.

Birth of Christian David Hunnicutt<sup>9</sup> on 10 January 1983.

Marriage of Gregory Wert<sup>57</sup> and Anna Carol Kelley<sup>56</sup> on 28 May 1983.

Death of Iva June Kennaday<sup>261</sup> on 16 March 2005.

**USA, INDIANA, KNOX**

Birth of James H Van Orsdel<sup>553</sup> on 11 February 1830.

Birth of Mary B Van Orsdel<sup>555</sup> on 21 June 1834.

Birth of Anne Elizabeth Van Orsdel<sup>341</sup> on 1 August 1836.

**USA, INDIANA, MARION, INDIANAPOLIS**

Birth of Norman Perry Curtis, Jr.<sup>67</sup> on 28 August 1966.

Birth of Melony Jo Curtis<sup>69</sup> on 14 January 1970.

Death of Melony Jo Curtis<sup>69</sup> on 8 December 1970.

Birth of David Earl Curtis<sup>72</sup> on 17 April 1973.

Birth of Mercedes Curtis<sup>17</sup> in August 1994.

Birth of Savanna June Curtis<sup>18</sup> on 14 June 1995.

Death of Ronald David Kelley, Jr.<sup>58</sup> on 15 September 1997.

**USA, KANSAS, CHAUTAUQUA, CEDER VALE**

Death of Jesse Rufus Kennedy<sup>514</sup> on 7 August 1899.

**USA, KANSAS, CHAUTAUQUA, CEDER VALE**

Birth of George Washington Kennedy<sup>510</sup> on 11 October 1870.

Birth of Sarah Jane Kennedy<sup>512</sup> on 11 December 1872.

Birth of Andrew Jackson Kennaday<sup>337</sup> on 15 July 1878.

Birth of Sarah Elizabeth Kennaday<sup>307</sup> on 1 November 1884.

Birth of Jesse Rufus Kennedy<sup>488</sup> on 17 May 1885.

Birth of Rosa Marie Kennaday<sup>308</sup> on 22 January 1886.



**USA, KANSAS, CHAUTAUQUA, CEDER VALE (continued)**

- Birth of Fredrick Fay Kennedy<sup>490</sup> on 21 January 1888.
- Birth of Anna Ruth Kennaday<sup>310</sup> on 30 January 1888.
- Birth of Alonso Kennaday<sup>312</sup> on 4 April 1889.
- Birth of Sadie Bell Kennedy<sup>491</sup> on 2 January 1890.
- Birth of Henry George Kennaday<sup>313</sup> on 11 May 1890.
- Birth of Lillie Irene Kennedy<sup>493</sup> on 4 May 1906.
- Death of Sarah Ann Ankrom<sup>515</sup> on 29 March 1920.
- Death of Anna Ruth Kennaday<sup>310</sup> on 6 November 1959.
- Birth of Clarence Bland Kennedy<sup>495</sup> on 9 April 1980.

**USA, KANSAS, COWLEY, WINDFIELD**

- Birth of Emma H Kennaday<sup>336</sup> on 10 September 1875.

**USA, KENTUCKY, BOONE**

- Marriage of John Hudson Kennaday<sup>340</sup> and Anne Elizabeth Van Orsdel<sup>341</sup> on 30 August 1855.

**USA, KENTUCKY, BOURBON**

- Birth of Abram Van Orsdel<sup>564</sup> on 31 December 1845.
- Birth of Edward S (Pete) Fitzpatrick<sup>372</sup> on 8 July 1916.
- Death of Edward S (Pete) Fitzpatrick<sup>372</sup> on 8 November 1978.

**USA, KENTUCKY, BOURBON, PARIS**

- Birth of Betty Carol Fitzpatrick<sup>155</sup> on 14 April 1947.

**USA, KENTUCKY, CARLISLE**

- Birth of Dorthy Mae Kelley<sup>407</sup> on 3 December 1932.
- Birth of Eugene Kelley<sup>409</sup> on 25 April 1935.
- Birth of Juanita Kelley<sup>411</sup> on 15 March 1937.
- Birth of Mary Elizabeth Kelley<sup>414</sup> on 2 January 1939.
- Birth of Wanda Lou Kelley<sup>416</sup> on 22 February 1942.
- Birth of Carolyn June Kelley<sup>156</sup> on 8 February 1945.
- Birth of Cristine Faye Kelley<sup>418</sup> on 9 December 1945.
- Birth of Brenda Jane Kelley<sup>421</sup> on 25 August 1951.
- Birth of James Luther Kelley, Jr.<sup>422</sup> on 14 February 1953.
- Birth of Bobby Gene Kelley<sup>385</sup> on 8 August 1954.
- Birth of Freddie Warren Kelley<sup>423</sup> on 24 September 1954.
- Birth of Donnie Lee Kelley<sup>424</sup> on 25 November 1955.
- Death of James Luther Kelley<sup>432</sup> on 27 March 1956.
- Death of Freddie Warren Kelley<sup>423</sup> on 4 November 1956.
- Birth of Billy Dean Kelley<sup>425</sup> on 9 June 1958.
- Death of Mary Elizabeth Minton<sup>443</sup> on 26 January 1961.
- Marriage of Norman Perry Curtis<sup>157</sup> and Carolyn June Kelley<sup>156</sup> on 12 January 1963.
- Marriage of Ronald David Kelley, Sr.<sup>154</sup> and Betty Carol Fitzpatrick<sup>155</sup> on 6 April 1963.
- Birth of Lisa June Kelley<sup>52</sup> on 18 December 1963.
- Death of John David Kelley<sup>262</sup> on 21 April 1970.

**USA, KENTUCKY, CITY POWEL, CLAY**

- Death of Rebecca K Boice<sup>571</sup> on 6 April 1900.

**USA, KENTUCKY, CLAY**

- Birth of Charles Alonzo Kennaday<sup>329</sup> on 8 November 1856.

**USA, KENTUCKY, CYNTHIANA**

- Birth of James Mickel Asbury<sup>54</sup>.

**USA, KENTUCKY, FAYETTE, LEXINGTON**

- Birth of Rebecca Ellen Van Orsdel<sup>557</sup> on 24 February 1839.
- Birth of Melinda Catherine Van Orsdel<sup>559</sup> on 14 October 1841.

**USA, KENTUCKY, FLEMMINGBURG**

Marriage of John David Kelley<sup>262</sup> and Iva June Kennaday<sup>261</sup> on 8 August 1948.

**USA, KENTUCKY, LEXINGTON**

Birth of Ronald David Kelley, Jr.<sup>58</sup> on 9 June 1966.

Birth of James Mathew Asbury<sup>10</sup> on 28 June 1991.

**USA, KENTUCKY, MERCER, HARRISBURG**

Birth of Jacob Boice<sup>576</sup>.

Birth of Katie Boice<sup>574</sup>.

Birth of Rebecca K Boice<sup>571</sup> on 16 April 1810.

Marriage of Gideon Wood<sup>573</sup> and Mary B Boice<sup>572</sup> in 1820.

Birth of William George Van Orsdel<sup>551</sup> on 15 December 1827.

Death of Millard Gulett<sup>377</sup> on 8 March 1960.

**USA, KENTUCKY, NICHLOS, ICARLISLE**

Birth of Anita Carol Curtis<sup>62</sup> on 9 April 1964.

**USA, KENTUCKY, NORTHMIDDLE TOWN**

Death of Betty Jack Osburn<sup>376</sup> in April 1961.

Death of William Allen Fitzpatrick<sup>375</sup> on 12 March 1965.

**USA, KENTUCKY, OWEN**

Birth of Henery George Van Orsdel<sup>567</sup> on 17 June 1849.

**USA, KENTUCKY, RICHMOND**

Birth of Virginia Ruth Gulett<sup>374</sup> on 23 February 1923.

**USA, KENTUCKY, SCOTT, CYNTHIANA**

Birth of Sarah E Van Orsdel<sup>561</sup> on 31 August 1843.

Birth of Isabell Van Orsdel<sup>565</sup> on 1 December 1846.

Marriage of James Mickel Asbury<sup>54</sup> and Lisa June Kelley<sup>52</sup> on 26 May 1990.

**USA, MISSOURI**

Marriage of George Washington Kennedy<sup>510</sup> and Mary Elizabeth Skelton<sup>511</sup> on 7 April 1889.

**USA, MISSOURI, BARRY, SELIGMAN**

Birth of Mary Elizabeth Skelton<sup>511</sup> on 14 August 1863.

**USA, MISSOURI, GREEN, SPRINGFIELD**

Birth of John W Kennaday<sup>334</sup> on 5 November 1870.

**USA, MISSOURI, POLK**

Death of Nancy Alice Martindale<sup>502</sup> on 27 August 1952.

**USA, NEW JERSEY**

Birth of Jacob Scomp<sup>588</sup>.

**USA, NEW MEXICO, RIO ARRIBA, EL VADO**

Birth of James Martin Marier<sup>265</sup> on 22 February 1920.

**USA, NEW YORK, YONKERS**

Birth of John Ellery Cooper<sup>237</sup> in 1954.

**USA, OHIO, CLEVELAND**

Birth of James Vencent Boyd<sup>21</sup> in 1956.

**USA, OHIO, GURNSEY**

Birth of Jesse Rufus Kennedy<sup>514</sup> on 2 March 1831.

**USA, OHIO, JACKSONTOWNSH**

Death of John Kennedy<sup>540</sup> on 10 August 1865.

**USA, OHIO, NOBLE**

Birth of Emiline Kennedy<sup>524</sup> on 9 January 1836.

**USA, OHIO, VENTON, ZALESKI**

Birth of Frances Elizabeth Kennedy<sup>330</sup> on 19 September 1864.

**USA, OHIO, VINTON**

Birth of Jonn Kennedy<sup>522</sup> on 19 June 1833.

Birth of Rebecca Kennedy<sup>528</sup> on 9 April 1845.

Birth of John Ronnie Kennedy<sup>501</sup> on 26 December 1857.

Birth of Andrew Kennedy<sup>503</sup> on 20 August 1860.

**USA, OHIO, VINTON, ZALESKI**

Birth of Samuel Kennedy<sup>525</sup> on 28 February 1837.

Birth of Sarah Jane Kennedy<sup>526</sup> on 16 June 1840.

**USA, OREGON, DOUGLAS, GLIDE**

Birth of Joshua Jolin Kennaday<sup>77</sup> in 1982.

**USA, OREGON, DOUGLAS, ROSEBURG**

Birth of Joan Olivia Debernardi<sup>267</sup> on 30 April 1929.

Birth of Gary Jo Kennaday<sup>165</sup> on 4 March 1946.

Birth of David Debernardi Kennaday<sup>167</sup> on 8 January 1949.

Birth of Paula Jo Smith<sup>168</sup> in 1953.

Birth of Steven Scott Kennaday<sup>169</sup> on 5 March 1956.

Birth of Fredrick Frank Kennaday<sup>172</sup> on 5 May 1957.

Birth of Nicholas Isaiah Kennaday<sup>74</sup> in 1978.

Birth of Elizabeth Alta Olivia Kennaday<sup>75</sup> in 1980.

Birth of Anthony Joseph Kennaday<sup>81</sup> in 1981.

Birth of Cristina Dianne Kennaday<sup>76</sup> in 1982.

**USA, ORGAN, JACKSON, MEDFORD**

Birth of Randy Eugene Sobo<sup>22</sup> on 7 July 1959.

Birth of Teresa Lynn Sobo<sup>24</sup> on 19 August 1960.

Birth of Justin Kyle Sobo<sup>3</sup> in 1982.

Birth of Julie Erin Sobo<sup>4</sup> in 1985.

Birth of Tyler Jamison Sobo<sup>6</sup> in 1987.

Birth of Travis Andrew Sobo<sup>5</sup> in 1987.

**USA, ORGAN, KLAMATH, FALLS, KLAMATH**

Birth of Brenda Sue Sobo<sup>20</sup> on 22 March 1958.

**USA, ORGAND, WASHINGTON, PORTLAND**

Birth of August Henry Geppert<sup>131</sup> in 1937.

Birth of Lori Ann Geppert<sup>28</sup> on 18 February 1960.

Birth of Judy Arlene Geppert<sup>30</sup> in 1962.

Birth of Tommy Duane Geppert<sup>32</sup> in 1964.

**USA, PENNSYLVANIA, GREEN**

Birth of John Ankrom<sup>542</sup> on 9 August 1809.

Birth of Richard Ankrom<sup>529</sup> on 5 February 1827.

Birth of Solomon Ankrom<sup>530</sup> on 8 August 1828.

Birth of Sarah Ann Ankrom<sup>515</sup> on 12 September 1830.

Birth of John Ellery Ankrom<sup>531</sup> on 2 June 1833.

Birth of Martha Ann Ankrom<sup>533</sup> on 4 November 1837.

Birth of William Ankrom<sup>534</sup> on 7 April 1840.

Birth of Uriah Ankrom<sup>535</sup> on 29 May 1842.

Birth of Elizabeth Ankrom<sup>536</sup> on 27 June 1844.

Birth of Miriah Ankrom<sup>537</sup> on 28 December 1846.

**USA, PENNSYLVANIA, GREEN (continued)**

Birth of Clementine Ankrom<sup>538</sup> on 21 November 1848.  
 Birth of Thomas Ankrom<sup>539</sup> on 1 May 1853.

**USA, PENNSYLVANIA, GREEN, WANESBURG**

Birth of Nancy Kennedy<sup>516</sup> on 1 January 1821.  
 Birth of Christine Kennedy<sup>518</sup> on 11 July 1822.

**USA, UTAH, CACHE, LOGAN**

Birth of Tiffany Anne Cooper<sup>120</sup> in 1977.  
 Birth of Hillary Ranee Cooper<sup>122</sup> in 1978.

**USA, UTAH, IRON, CEDER CITY**

Birth of Kae Porter<sup>235</sup> in 1957.

**USA, UTAH, SALT LAKE, SALT LAKE CITY**

Birth of Triana Marie Campbell<sup>107</sup> in 1978.  
 Birth of Holly Ann Campbell<sup>108</sup> in 1980.  
 Birth of Eric Raymond Campbell<sup>109</sup> in 1985.

**USA, UTAH, WEBER, OGDEN**

Birth of Thomas Elliott Page<sup>104</sup> in 1971.

**USA, WYOMING, CARBON**

Death of Anne Elizabeth Van Orsdel<sup>341</sup> on 10 February 1916.

**USA, WYOMING, CARBON, DEC. 9 1940 AT SARATOGA**

Burial of Charles Alonzo Kennaday<sup>329</sup>.

**USA, WYOMING, CARBON, HANNA**

Birth of Beverly Ann Johnson<sup>295</sup> in 1928.

**USA, WYOMING, CARBON, RAWLINS**

Birth of Logan Turner Cairns<sup>325</sup> in 1894.  
 Birth of Jack Lavoy Cairns<sup>294</sup> in 1930.  
 Marriage of Thomas Earl Kennaday<sup>252</sup> and Gladys Eleanor Ream<sup>253</sup> on 13 May 1933.  
 Birth of Margaret Faunita Cairns<sup>296</sup> in 1933.  
 Birth of Patty Ray Kennaday<sup>130</sup> on 3 August 1937.  
 Birth of Dorothy Lorraine Cairns<sup>298</sup> in 1941.  
 Birth of Judy Ann Cairns<sup>299</sup> in 1946.  
 Birth of Christine Marie Cairns<sup>228</sup> in 1951.  
 Birth of Richard Norman Wilson<sup>238</sup> in 1953.  
 Birth of Kenneth Logan Wilson<sup>239</sup> in 1954.  
 Birth of Elizabeth Kay Cairns<sup>232</sup> in 1954.  
 Birth of William Wayne Cairns<sup>234</sup> in 1955.  
 Birth of Phyllis Ann Wilson<sup>240</sup> in 1955.  
 Birth of Rebecca Gay Cairns<sup>236</sup> in 1956.  
 Birth of Johnathan Jack Page<sup>105</sup> in 1973.  
 Birth of Donald Grant Page<sup>106</sup> in 1975.  
 Birth of Kreeta Ann Jebens<sup>123</sup> in 1975.  
 Birth of Korey Kay Jebens<sup>124</sup> in 1977.  
 Death of Alice Oda May Kennaday<sup>320</sup> on 6 December 1979.  
 Birth of Carlie Norman Jebens<sup>125</sup> in 1979.  
 Death of Emma Helen Kennaday<sup>324</sup> on 26 August 1988.

**USA, WYOMING, CARBON, SARATOGA**

Birth of Harry Otis Kennaday<sup>314</sup> on 8 October 1892.  
 Birth of Frank Forest Kennaday<sup>316</sup> on 6 November 1893.  
 Birth of Edward Thomas Kennaday<sup>318</sup> on 9 October 1895.  
 Birth of Alice Oda May Kennaday<sup>320</sup> on 13 April 1897.  
 Birth of Charles Fredrick Kennaday<sup>322</sup> on 30 November 1898.

**USA, WYOMING, CARBON, SARATOGA (continued)**

- Birth of Alice Mannahan<sup>319</sup> in 1900.  
 Birth of Loyd Andrew Kennaday<sup>326</sup> on 2 August 1903.  
 Birth of Emma Helen Kennaday<sup>324</sup> on 8 December 1905.  
 Birth of Fay Kennaday<sup>328</sup> on 14 June 1907.  
 Birth of Thomas Earl Kennaday<sup>252</sup> on 7 July 1914.  
 Birth of Florence Mae Kennaday<sup>254</sup> on 28 June 1917.  
 Birth of Vita Maude Davidson<sup>277</sup> in 1918.  
 Birth of Forest Jack Kennaday<sup>257</sup> on 22 November 1919.  
 Birth of Ellen (Dude) Stockwell<sup>258</sup> in 1919.  
 Birth of Louize Gertrude Davidson<sup>281</sup> in 1920.  
 Birth of William C Kennaday<sup>268</sup> in 1920.  
 Birth of Rose Marie Kennaday<sup>259</sup> on 10 October 1921.  
 Birth of Iva June Kennaday<sup>261</sup> on 13 June 1923.  
 Death of Andrew Jackson Kennaday<sup>337</sup> on 8 December 1923.  
 Birth of John E Kennaday<sup>269</sup> in 1927.  
 Birth of Lincoln Frank Kennaday<sup>266</sup> on 9 April 1928.  
 Birth of Catherine Marie Kennaday<sup>271</sup> in 1931.  
 Birth of Mary Lou Kennaday<sup>270</sup> in 1931.  
 Birth of Fred E Kennaday<sup>272</sup> in 1932.  
 Birth of Thomas Eugene Kennaday<sup>128</sup> on 14 August 1935.  
 Marriage of Loyd Andrew Kennaday<sup>326</sup> and Inez Henderson<sup>327</sup> on 23 October 1937.  
 Death of Frances Elizabeth Kennedy<sup>330</sup> on 10 June 1938.  
 Birth of Jack J Kennaday<sup>301</sup> on 18 September 1938.  
 Birth of Alice Ann Kennaday<sup>274</sup> in 1938.  
 Death of Mable Pierce<sup>317</sup> on 27 May 1940.  
 Death of Charles Alonzo Kennaday<sup>329</sup> on 6 December 1940.  
 Birth of Carl L Kennaday<sup>302</sup> on 18 December 1940.  
 Birth of Joy L Kennaday<sup>304</sup> on 17 April 1942.  
 Birth of Donald Fay Kennaday<sup>306</sup> on 18 May 1944.  
 Death of Anna Marshel<sup>338</sup> on 8 December 1960.  
 Death of Inez Henderson<sup>327</sup> on 22 September 1991.

**USA, WYOMING, LARAMIE, CHEYENNE**

- Death of Harry Otis Kennaday<sup>314</sup> on 25 April 1940.  
 Birth of Amy Nichole Schmeling<sup>243</sup> in 1978.

**USA, WYOMING, PLATTE, WEATLAND**

- Birth of Tyler Martin Schmeling<sup>242</sup> in 1976.

**USA, WYOMING, PLATTE, WHITTEMORE**

- Birth of Craig Martin Schmeling<sup>300</sup> in 1945.

**USA, WYOMING, SUBLETTE, BIGPINEY**

- Birth of Nelson Chester Whitman<sup>174</sup> in 1939.  
 Birth of Boyd David Whitman<sup>178</sup> in 1940.  
 Birth of Richard Ward Whitman<sup>180</sup> in 1941.  
 Birth of Charlotte Louize Whitman<sup>182</sup> in 1944.

**USA, WYOMING, SWEETWATER, ROCK SPRINGS**

- Birth of Jack Lavoy Cairns, Jr.<sup>230</sup> in 1953.

**VIRGINIA, OLD VIRGINIA**

- Birth of Mary Elizabeth Minton<sup>443</sup> on 26 August 1876.

**WYOMING, 1988 RAWLINS, AUG 30**

- Burial of Emma Helen Kennaday<sup>324</sup>.

**WYOMING, JUNE 13 1938 SARATOGA**

Burial of Frances Elizabeth Kennedy<sup>330</sup>.

**WYOMING, SARATOGA**

Burial of Harry Otis Kennaday<sup>314</sup>.

Marriage of Fred Peters<sup>309</sup> and Rosa Marie Kennaday<sup>308</sup> on 7 March 1904.

Death of Rosa Marie Kennaday<sup>308</sup> on 22 July 1907.

## 16. INDEX OF DATES

- 1795** Birth of John Kennedy<sup>540</sup> on 9 January, in Dublin, Ireland.
- 1797** Birth of Sarah Jane Raynor<sup>541</sup> on 10 October, in Waynesburg, Green, Pennsylvania USA.
- 1807** Birth of Ruth Unknown<sup>543</sup> on 2 April.
- 1808** Birth of Abram F Van Orsdel, Jr.<sup>570</sup>.
- 1809** Birth of John Ankrom<sup>542</sup> on 9 August, in Green, Pennsylvania, USA.
- 1810** Birth of Rebecca K Boice<sup>571</sup> on 16 April, in Harrisburg, Mercer, Kentucky, USA.
- 1818** Marriage of John Kennedy<sup>540</sup> and Sarah Jane Raynor<sup>541</sup>.
- 1820** Marriage of Gideon Wood<sup>573</sup> and Mary B Boice<sup>572</sup> in Harrisburg, Mercer, Kentucky, USA.
- 1821** Birth of Nancy Kennedy<sup>516</sup> on 1 January, in Wanesburg, Green, Pennsylvania, USA.
- 1822** Birth of Christine Kennedy<sup>518</sup> on 11 July, in Wanesburg, Green, Pennsylvania, USA.
- 1823** Birth of Joseph Bryson Kennaday<sup>339</sup> on 22 February.
- 1825** Birth of John Hudson Kennaday<sup>340</sup> on 13 June.
- 1826** Marriage of John Ankrom<sup>542</sup> and Ruth Unknown<sup>543</sup> on 7 May.  
Birth of James Leighton Kennedy<sup>520</sup> on 10 November, in Waynesburg, Green, Pennsylvania USA.  
Birth of Jacob Kennedy<sup>519</sup> on 10 November, in Wanyesburg, Green, Pennsylvania USA.
- 1827** Birth of Richard Ankrom<sup>529</sup> on 5 February, in Green, Pennsylvania, USA.  
Marriage of Abram F Van Orsdel, Jr.<sup>570</sup> and Rebecca K Boice<sup>571</sup> on 27 February.  
Birth of William George Van Orsdel<sup>551</sup> on 15 December, in Harrisburg, Mercer, Kentucky, USA.
- 1828** Birth of Zarilda Kennaday<sup>342</sup> on 16 March.  
Birth of Solomon Ankrom<sup>530</sup> on 8 August, in Green, Pennsylvania, USA.
- 1830** Birth of James H Van Orsdel<sup>553</sup> on 11 February, in Knox, Indiana, USA.  
Birth of Sarah Ann Ankrom<sup>515</sup> on 12 September, in Green, Pennsylvania, USA.
- 1831** Birth of Jesse Rufus Kennedy<sup>514</sup> on 2 March, in Gurnsey, Ohio, USA.
- 1833** Birth of John Ellery Ankrom<sup>531</sup> on 2 June, in Green, Pennsylvania, USA.  
Birth of Jonn Kennedy<sup>522</sup> on 19 June, in Vinton, Ohio, USA.
- 1834** Marriage of Edward Kelley<sup>472</sup> and America Mull<sup>473</sup> on 16 February.  
Birth of Mary Vicker Kennaday<sup>343</sup> on 18 March.  
Birth of Mary B Van Orsdel<sup>555</sup> on 21 June, in Knox, Indiana, USA.
- 1835** Birth of Mary Ann Ankrom<sup>532</sup> on 14 July.
- 1836** Birth of Emiline Kennedy<sup>524</sup> on 9 January, in Noble, Ohio, USA.  
Birth of Anne Elizabeth Van Orsdel<sup>341</sup> on 1 August, in Knox, Indiana, USA.
- 1837** Birth of Samuel Kennedy<sup>525</sup> on 28 February, in Zaleski, Vinton, Ohio, USA.  
Birth of Martha Ann Ankrom<sup>533</sup> on 4 November, in Green, Pennsylvania, USA.
- 1839** Birth of Rebecca Ellen Van Orsdel<sup>557</sup> on 24 February, in Lexington, Fayette, Kentucky, USA.
- 1840** Birth of William Ankrom<sup>534</sup> on 7 April, in Green, Pennsylvania, USA.  
Birth of Sarah Jane Kennedy<sup>526</sup> on 16 June, in Zaleski, Vinton, Ohio, USA.

- 1841**  
Birth of Melinda Catherine Van Orsdel<sup>559</sup> on 14 October, in Lexington, Fayette, Kentucky, USA.
- 1842**  
Birth of Uriah Ankrom<sup>535</sup> on 29 May, in Green, Pennsylvania, USA.  
Birth of Elizabeth Kennedy<sup>527</sup> on 16 June.  
Marriage of Benjamin Kirk Shepherd<sup>517</sup> and Nancy Kennedy<sup>516</sup> on 29 December.
- 1843**  
Birth of Sarah E Van Orsdel<sup>561</sup> on 31 August, in Cynthiana, Scott, Kentucky, USA.
- 1844**  
Birth of Elizabeth Ankrom<sup>536</sup> on 27 June, in Green, Pennsylvania, USA.
- 1845**  
Birth of Rebecca Kennedy<sup>528</sup> on 9 April, in Vinton, Ohio, USA.  
Birth of Abram Van Orsdel<sup>564</sup> on 31 December, in Bourbon, Kentucky, USA.
- 1846**  
Death of Abram Van Orsdel<sup>564</sup> on 4 January.  
Birth of Isabell Van Orsdel<sup>565</sup> on 1 December, in Cynthiana, Scott, Kentucky, USA.  
Birth of Miriah Ankrom<sup>537</sup> on 28 December, in Green, Pennsylvania, USA.
- 1848**  
Birth of Clementine Ankrom<sup>538</sup> on 21 November, in Green, Pennsylvania, USA.
- 1849**  
Birth of Henery George Van Orsdel<sup>567</sup> on 17 June, in Owen, Kentucky, USA.  
Death of Abram F Van Orsdel, Jr.<sup>570</sup>.
- 1850**  
Death of Solomon Ankrom<sup>530</sup> on 2 June.  
Death of John Ellery Ankrom<sup>531</sup> on 14 June.
- 1851**  
Marriage of William George Van Orsdel<sup>551</sup> and Sarah Catterson<sup>552</sup> on 22 February.  
Birth of James M Minton<sup>466</sup> on 3 April.  
Marriage of Jesse Rufus Kennedy<sup>514</sup> and Sarah Ann Ankrom<sup>515</sup> on 11 December, in Ohio.
- 1852**  
Birth of Emaline Kennedy<sup>497</sup> on 25 October.
- 1853**  
Birth of Thomas Ankrom<sup>539</sup> on 1 May, in Green, Pennsylvania, USA.
- 1854**  
Birth of Mariah Kennedy<sup>498</sup> on 13 March.  
Marriage of James H Van Orsdel<sup>553</sup> and Sallie Matoxx<sup>554</sup> on 22 July.
- 1855**  
Death of James Kennaday<sup>348</sup> on 5 May.  
Death of Martha Ann Ankrom<sup>533</sup> on 24 June.  
Marriage of John Hudson Kennaday<sup>340</sup> and Anne Elizabeth Van Orsdel<sup>341</sup> on 30 August, in Boone, Kentucky, USA.  
Birth of Nanch Isabell Kennedy<sup>500</sup> on 25 December.
- 1856**  
Marriage of Erasmus E Kelley<sup>470</sup> and Mary Mc Iwoan<sup>471</sup> on 17 March.  
Birth of Margaret Johnson<sup>467</sup> on 8 May.  
Birth of Charles Alonzo Kennaday<sup>329</sup> on 8 November, in Clay, Kentucky, USA.
- 1857**  
Birth of John Ronnie Kennedy<sup>501</sup> on 26 December, in Vinton, Ohio, USA.
- 1858**  
Birth of Thomas Earl Pearce<sup>479</sup> on 6 June, in London, England.  
Birth of James Edward Kennaday<sup>331</sup> on 15 July, in Lexington, Mclean, Illinois, USA.
- 1860**  
Marriage of William B Hewitt<sup>558</sup> and Rebecca Ellen Van Orsdel<sup>557</sup> on 13 February.  
Death of Emaline Kennedy<sup>497</sup> on 27 February.  
Death of Uriah Ankrom<sup>535</sup> on 3 March.  
Death of Nanch Isabell Kennedy<sup>500</sup> in March.  
Birth of Andrew Kennedy<sup>503</sup> on 20 August, in Vinton, Ohio, USA.
- 1861**  
Birth of Ida Jane Kennaday<sup>332</sup> on 4 April, in Lexington, Mclean, Illinois, USA.  
Marriage of Jonn Kennedy<sup>522</sup> and Lydia Jarvis<sup>523</sup> on 6 October, in Nobel.  
Marriage of John Benjamin Pollard<sup>560</sup> and Melinda Catherine Van Orsdel<sup>559</sup> on 31 December.



- 1862**  
Birth of Samuel Rufus Kennedy<sup>505</sup> on 24 October.
- 1863**  
Birth of Lewis Lute Kelley<sup>464</sup> on 5 February, in Nichlos, County, Kentucky.  
Death of William George Van Orsdel<sup>551</sup> on 19 February.  
Birth of Mary Elizabeth Skelton<sup>511</sup> on 14 August, in Seligman, Barry, Missouri, USA.
- 1864**  
Birth of Frances Elizabeth Kennedy<sup>330</sup> on 19 September, in Zaleski, Venton, Ohio, USA.  
Birth of Nancy Alice Martindale<sup>502</sup> on 2 November.
- 1865**  
Birth of Amelia Frances Bowles<sup>465</sup> on 20 June.  
Death of John Kennedy<sup>540</sup> on 10 August, in JacksoTownsh, Ohio, USA.
- 1866**  
Death of Clementine Ankrom<sup>538</sup> on 8 April.  
Birth of James Franklin Kennedy<sup>507</sup> on 15 November, in Boody, Macon, Illinois.  
Marriage of James H Wallace<sup>566</sup> and Isabell Van Orsdel<sup>565</sup> on 25 December.  
Marriage of Henery George Van Orsdel<sup>567</sup> and Annie E Mitchell<sup>568</sup>.
- 1868**  
Birth of Mary V Kennaday<sup>333</sup> on 12 January, in Cherokee Nation, USA.  
Marriage of Thomas Rogers<sup>562</sup> and Sarah E Van Orsdel<sup>561</sup> on 3 July.  
Birth of William Edson Kennedy<sup>509</sup> on 15 October, in Boody, Macon, Illinois.
- 1869**  
Death of Mary V Kennaday<sup>333</sup> on 4 October.
- 1870**  
Marriage of William S Kelley<sup>468</sup> and Elizabeth Smith<sup>469</sup> on 21 May.  
Birth of George Washington Kennedy<sup>510</sup> on 11 October, in Ceder Vale, Chautauqua, Kansas, USA.  
Birth of John W Kennaday<sup>334</sup> on 5 November, in Springfield, Green, Missouri, USA.
- 1872**  
Birth of Mary Adele Lambs- Cobb<sup>481</sup> on 24 September, in Macon, Missouri.  
Birth of Sarah Jane Kennedy<sup>512</sup> on 11 December, in Ceder Vale, Chautauqua, Kansas, USA.
- 1875**  
Death of James Leighton Kennedy<sup>520</sup> on 19 March.  
Death of Elizabeth Rhineheart<sup>521</sup> on 19 March.  
Birth of Anne E D Kennaday<sup>335</sup> on 29 April, in Lexington, Mclean, Illinois, USA.  
Birth of Emma H Kennaday<sup>336</sup> on 10 September, in Windfield, Cowley, Kansas, USA.  
Birth of Anna Marshel<sup>338</sup>.
- 1876**  
Birth of Della Minton<sup>452</sup> on 26 February.  
Birth of Mary Elizabeth Minton<sup>443</sup> on 26 August, in Old Virginia, Virginia.
- 1877**  
Marriage of Alferd Shidler<sup>499</sup> and Mariah Kennedy<sup>498</sup> on 20 August.  
Marriage of Henery George Van Orsdel<sup>567</sup> and Mattie Anderson<sup>569</sup>.
- 1878**  
Birth of Andrew Jackson Kennaday<sup>337</sup> on 15 July, in Ceder Vale, Chautauqua, Kansas, USA.
- 1880**  
Death of Sarah Jane Kennedy<sup>512</sup> on 20 March.  
Birth of Isabell May Minton<sup>453</sup> on 15 May.
- 1882**  
Death of Rebecca Kennedy<sup>528</sup> on 1 January.  
Marriage of Andrew Kennedy<sup>503</sup> and Effie Bacus<sup>504</sup> on 9 May.  
Birth of Ida Catherine Minton<sup>454</sup> on 9 May.  
Marriage of John Ronnie Kennedy<sup>501</sup> and Nancy Alice Martindale<sup>502</sup> on 6 September.
- 1883**  
Death of Ida Jane Kennaday<sup>332</sup> on 5 April.  
Birth of Millard Gulett<sup>377</sup> on 11 August, in Bretthett, Kentucky.  
Marriage of Charles Alonzo Kennaday<sup>329</sup> and Frances Elizabeth Kennedy<sup>330</sup> on 11 November, in Cedarvale, Chauauqua, Kansas, USA at Church of Crist.
- 1884**  
Birth of James Minton<sup>455</sup> on 7 August.  
Marriage of Lewis Lute Kelley<sup>464</sup> and Amelia Frances Bowles<sup>465</sup> on 14 October.  
Death of Sarah Elizabeth Kennaday<sup>307</sup> on 1 November.  
Birth of Sarah Elizabeth Kennaday<sup>307</sup> on 1 November, in Ceder Vale, Chautauqua, Kansas, USA.

**1885**

Birth of Jesse Rufus Kennedy<sup>488</sup> on 17 May, in Ceder Vale, Chautauqua, Kansas, USA.

**1886**

Birth of Rosa Marie Kennaday<sup>308</sup> on 22 January, in Ceder Vale, Chautauqua, Kansas, USA.

Birth of Maggie Minton<sup>456</sup> on 13 April.

Marriage of Samuel Rufus Kennedy<sup>505</sup> and Lillie Tredway<sup>506</sup> on 8 July.

Birth of Talmadge Blane Kelley<sup>442</sup> on 12 July, in Vandervill, Kentucky.

**1887**

Birth of William Allen Fitzpatrick<sup>375</sup> on 3 February.

Death of John Ankrom<sup>542</sup> on 12 May.

**1888**

Birth of Fredrick Fay Kennedy<sup>490</sup> on 21 January, in Ceder Vale, Chautauqua, Kansas, USA.

Birth of Anna Ruth Kennaday<sup>310</sup> on 30 January, in Ceder Vale, Chautauqua, Kansas, USA.

Death of Sarah Jane Raynor<sup>541</sup> on 8 April.

Birth of Carrie Minton<sup>457</sup> on 7 June.

Marriage of Noah Diehl<sup>563</sup> and Sarah E Van Orsdel<sup>561</sup> on 13 June.

Birth of Cora Elizabeth Hutchchison<sup>378</sup> on 29 September.

Marriage of James Phipps<sup>480</sup> and Mary Adele Lambs- Cobb<sup>481</sup>.

**1889**

Death of William Edson Kennedy<sup>509</sup> on 12 March.

Death of Alonso Kennaday<sup>312</sup> on 4 April.

Birth of Alonso Kennaday<sup>312</sup> on 4 April, in Ceder Vale, Chautauqua, Kansas, USA.

Marriage of George Washington Kennedy<sup>510</sup> and Mary Elizabeth Skelton<sup>511</sup> on 7 April, in Missouri, USA.

**1890**

Birth of Sadie Bell Kennedy<sup>491</sup> on 2 January, in Ceder Vale, Chautauqua, Kansas, USA.

Death of Isabell Van Orsdel<sup>565</sup> on 24 March.

Birth of Henry George Kennaday<sup>313</sup> on 11 May, in Ceder Vale, Chautauqua, Kansas, USA.

Birth of Rosayella Minton<sup>459</sup> on 7 October.

**1892**

Birth of Phillys Minton<sup>460</sup> on 8 October.

Birth of Harry Otis Kennaday<sup>314</sup> on 8 October, in Saratoga, Carbon, Wyoming, USA.

**1893**

Birth of Frank Forest Kennaday<sup>316</sup> on 6 November, in Saratoga, Carbon, Wyoming, USA.

Birth of Alice Pearce<sup>477</sup> on 28 December, in Denver, Colorado.

**1894**

Birth of Walter Minton<sup>462</sup> on 12 August.

Birth of Fairfax Harry Davidson<sup>321</sup>.

Birth of Logan Turner Cairns<sup>325</sup> in Rawlins, Carbon, Wyoming, USA.

**1895**

Death of Sarah E Van Orsdel<sup>561</sup> on 27 February.

Birth of Edward Thomas Kennaday<sup>318</sup> on 9 October, in Saratoga, Carbon, Wyoming, USA.

**1896**

Death of Samuel Rufus Kennedy<sup>505</sup> on 29 January.

Birth of Ethel Minton<sup>463</sup> on 1 June.

**1897**

Birth of Mable Pierce<sup>317</sup> on 5 January, in Denver, Colorado.

Birth of Alice Oda May Kennaday<sup>320</sup> on 13 April, in Saratoga, Carbon, Wyoming, USA.

**1898**

Birth of Charles Fredrick Kennaday<sup>322</sup> on 30 November, in Saratoga, Carbon, Wyoming, USA.

**1899**

Marriage of James Franklin Kennedy<sup>507</sup> and Louise Whited<sup>508</sup> on 11 March.

Death of Joseph Bryson Kennaday<sup>339</sup> on 20 May.

Death of Jesse Rufus Kennedy<sup>514</sup> on 7 August, in Ceder Vale, Chautauqua, Kansas, USA.

**1900**

Death of Rebecca K Boice<sup>571</sup> on 6 April, in Clay, City Powel, Kentucky, USA.

Birth of Alice Mannahan<sup>319</sup> in Saratoga, Carbon, Wyoming, USA.

**1901**

Death of Henry George Kennaday<sup>313</sup> on 20 May.

Death of Nancy Kennedy<sup>516</sup>.

**1903**

Birth of Loyd Andrew Kennaday<sup>326</sup> on 2 August, in Saratoga, Carbon, Wyoming, USA.

**1904**

Marriage of Fred Peters<sup>309</sup> and Rosa Marie Kennaday<sup>308</sup> on 7 March, in Saratoga, Wyoming.

**1905**

Marriage of Ed Stewart<sup>311</sup> and Anna Ruth Kennaday<sup>310</sup> on 30 September.

Birth of Emma Helen Kennaday<sup>324</sup> on 8 December, in Saratoga, Carbon, Wyoming, USA.

**1906**

Birth of Lillie Irene Kennedy<sup>493</sup> on 4 May, in Ceder Vale, Chautauqua, Kansas, USA.

Birth of Mable Vilote Stewart<sup>246</sup>.

**1907**

Death of Mary Vicker Kennaday<sup>343</sup> on 18 February.

Birth of Fay Kennaday<sup>328</sup> on 14 June, in Saratoga, Carbon, Wyoming, USA.

Death of Rosa Marie Kennaday<sup>308</sup> on 22 July, in Saratoga, Wyoming.

**1908**

Marriage of Jay McClure<sup>492</sup> and Sadie Bell Kennedy<sup>491</sup> on 29 January.

Death of Fredrick Fay Kennedy<sup>490</sup> on 29 November.

**1909**

Marriage of Talmadge Blane Kelley<sup>442</sup> and Mary Elizabeth Minton<sup>443</sup> on 16 December.

Birth of Frances Luella Stewart<sup>247</sup>.

**1910**

Marriage of Jesse Rufus Kennedy<sup>488</sup> and Fay McClure<sup>489</sup> on 6 April.

**1911**

Birth of James Luther Kelley<sup>432</sup> on 31 March.

Death of Mariah Kennedy<sup>498</sup> on 14 November.

Birth of Earl N Ramsey<sup>256</sup>.

**1912**

Death of John Hudson Kennaday<sup>340</sup> on 8 November.

Birth of George Martin Stewart<sup>248</sup>.

**1913**

Marriage of Frank Forest Kennaday<sup>316</sup> and Mable Pierce<sup>317</sup> on 4 July.

Birth of Walter Cecil Ackerson<sup>286</sup>.

**1914**

Death of Mary B Van Orsdel<sup>555</sup> on 11 March.

Birth of Thomas Earl Kennaday<sup>252</sup> on 7 July, in Saratoga, Carbon, Wyoming, USA.

Birth of Gladys Eleanor Ream<sup>253</sup> in Superior, Colorado, USA.

**1915**

Birth of Inez Henderson<sup>327</sup> on 3 February.

Birth of Harvey Alton Blackburn<sup>282</sup>.

**1916**

Death of Anne Elizabeth Van Orsdel<sup>341</sup> on 10 February, in Carbon, Wyoming, USA.

Marriage of Fairfax Harry Davidson<sup>321</sup> and Alice Oda May Kennaday<sup>320</sup> on 11 May.

Birth of Edward S (Pete) Fitzpatrick<sup>372</sup> on 8 July, in Bourbon, Kentucky, USA.

**1917**

Birth of Talmadge Blane Kelley, Jr.<sup>434</sup> on 28 January.

Birth of Florence Mae Kennaday<sup>254</sup> on 28 June, in Saratoga, Carbon, Wyoming, USA.

Death of James M Minton<sup>466</sup> on 23 October.

Birth of John David Kelley<sup>262</sup> on 28 December.

Birth of Frances Amonda Davidson<sup>275</sup> in Denver, Adams, Colorado, USA.

**1918**

Death of James Franklin Kennedy<sup>507</sup> on 21 January.

Marriage of Edward Thomas Kennaday<sup>318</sup> and Alice Mannahan<sup>319</sup> on 11 August.

Birth of Vita Maude Davidson<sup>277</sup> in Saratoga, Carbon, Wyoming, USA.

Birth of Robert Orrin Rogerson<sup>278</sup>.

**1919**

Birth of Cristine Sapp<sup>433</sup> on 15 February.

Birth of Forest Jack Kennaday<sup>257</sup> on 22 November, in Saratoga, Carbon, Wyoming, USA.

Birth of Ellen (Dude) Stockwell<sup>258</sup> in Saratoga, Carbon, Wyoming, USA.

- 1920**  
 Birth of James Martin Marier<sup>265</sup> on 22 February, in El Vado, Rio Arriba, New Mexico, USA.  
 Death of Sarah Ann Ankrom<sup>515</sup> on 29 March, in Ceder Vale, Chautauqua, Kansas, USA.  
 Birth of Louize Gertrude Davidson<sup>281</sup> in Saratoga, Carbon, Wyoming, USA.  
 Death of William C Kennaday<sup>268</sup>.  
 Birth of William C Kennaday<sup>268</sup> in Saratoga, Carbon, Wyoming, USA.  
 Birth of Bruce Douglas Whitman<sup>276</sup>.
- 1921**  
 Death of Rebecca Ellen Van Orsdel<sup>557</sup> on 18 January.  
 Birth of Rose Marie Kennaday<sup>259</sup> on 10 October, in Saratoga, Carbon, Wyoming, USA.  
 Birth of Olive Ruth Stewart<sup>249</sup> in Blue Lake, Humboldt, Calaforina, USA.  
 Birth of Chester Clark Davidson<sup>283</sup>.
- 1922**  
 Death of Sadie Bell Kennedy<sup>491</sup> on 5 December.
- 1923**  
 Birth of Virginia Ruth Gulett<sup>374</sup> on 23 February, in Richmond, Kentucky, USA.  
 Death of Emiline Kennedy<sup>524</sup> on 19 May.  
 Birth of Iva June Kennaday<sup>261</sup> on 13 June, in Saratoga, Carbon, Wyoming, USA.  
 Death of Andrew Jackson Kennaday<sup>337</sup> on 8 December, in Saratoga, Carbon, Wyoming, USA.  
 Birth of Eleanora Alice Davidson<sup>285</sup>.
- 1925**  
 Birth of Bonnie Jean Kennaday<sup>263</sup> on 6 April.  
 Marriage of Logan Turner Cairns<sup>325</sup> and Emma Helen Kennaday<sup>324</sup> on 3 December, in Denver, Denver, Colorado, USA.
- 1926**  
 Death of John Ronnie Kennedy<sup>501</sup> on 20 January.
- 1927**  
 Birth of John E Kennaday<sup>269</sup> in Saratoga, Carbon, Wyoming, USA.  
 Death of John E Kennaday<sup>269</sup>.  
 Birth of Charles Daniel Davidson<sup>287</sup>.
- 1928**  
 Birth of Lincoln Frank Kennaday<sup>266</sup> on 9 April, in Saratoga, Carbon, Wyoming, USA.  
 Birth of Beverly Ann Johnson<sup>295</sup> in Hanna, Carbon, Wyoming, USA.
- 1929**  
 Birth of Joan Olivia Debernardi<sup>267</sup> on 30 April, in Roseburg, Douglas, Oregon, USA.  
 Death of Andrew Kennedy<sup>503</sup> on 12 September.  
 Birth of Earlene Dee Noller<sup>288</sup>.  
 Birth of Myrtle Rae Davidson<sup>289</sup>.  
 Birth of Charles Leroy Stewart<sup>250</sup> in Blue Lake, Humboldt, Calaforina, USA.
- 1930**  
 Birth of Jack Lavoy Cairns<sup>294</sup> in Rawlins, Carbon, Wyoming, USA.
- 1931**  
 Death of Talmadge Blane Kelley<sup>442</sup> on 6 February.  
 Death of George Washington Kennedy<sup>510</sup> on 30 March.  
 Birth of Mary Lou Kennaday<sup>270</sup> in Saratoga, Carbon, Wyoming, USA.  
 Birth of Catherine Marie Kennaday<sup>271</sup> in Saratoga, Carbon, Wyoming, USA.
- 1932**  
 Marriage of James Luther Kelley<sup>432</sup> and Cristine Sapp<sup>433</sup> on 10 June.  
 Death of Lewis Lute Kelley<sup>464</sup> on 25 July, in Ad Richeys home in Myers station.  
 Birth of Dorthy Mae Kelley<sup>407</sup> on 3 December, in Carlisle, Kentucky, USA.  
 Birth of Fred E Kennaday<sup>272</sup> in Saratoga, Carbon, Wyoming, USA.
- 1933**  
 Marriage of Thomas Earl Kennaday<sup>252</sup> and Gladys Eleanor Ream<sup>253</sup> on 13 May, in Rawlins, Carbon, Wyoming, USA.  
 Marriage of Charles Fredrick Kennaday<sup>322</sup> and Margaret Bays<sup>323</sup> on 18 July.  
 Birth of Cornell Alexander Sobo, Jr.<sup>127</sup> on 28 October.  
 Birth of Charlotte Arlene Kennaday<sup>126</sup> on 28 October.  
 Birth of Margaret Faunita Cairns<sup>296</sup> in Rawlins, Carbon, Wyoming, USA.  
 Death of Fred E Kennaday<sup>272</sup>.
- 1934**  
 Death of Melinda Catherine Van Orsdel<sup>559</sup> on 6 June.  
 Death of James Edward Kennaday<sup>331</sup> on 6 June.

**1935**

Birth of Eugene Kelley<sup>409</sup> on 25 April, in Carlisle, Kentucky, USA.  
 Birth of Thomas Eugene Kennaday<sup>128</sup> on 14 August, in Saratoga, Carbon, Wyoming, USA.  
 Marriage of Earl N Ramsey<sup>256</sup> and Florence Mae Kennaday<sup>254</sup> on 21 October.  
 Birth of Ronald Clark Redman<sup>291</sup>.

**1936**

Death of Catherine Marie Kennaday<sup>271</sup>.

**1937**

Birth of Juanita Kelley<sup>411</sup> on 15 March, in Carlisle, Kentucky, USA.  
 Birth of Earl Efton (Butch) Ramsey<sup>132</sup> on 24 April.  
 Birth of Patty Ray Kennaday<sup>130</sup> on 3 August, in Rawlins, Carbon, Wyoming, USA.  
 Birth of Rosa L Hubbard<sup>133</sup> on 26 September.  
 Marriage of Loyd Andrew Kennaday<sup>326</sup> and Inez Henderson<sup>327</sup> on 23 October, in Saratoga, Carbon, Wyoming, USA.  
 Birth of August Henry Geppert<sup>131</sup> in Portland, Washington, Oregon, USA.

**1938**

Death of Margaret Johnson<sup>467</sup> on 7 March.  
 Death of Frances Elizabeth Kennedy<sup>330</sup> on 10 June, in Saratoga, Carbon, Wyoming, USA.  
 Birth of Jack J Kennaday<sup>301</sup> on 18 September, in Saratoga, Carbon, Wyoming, USA.  
 Birth of Alice Ann Kennaday<sup>274</sup> in Saratoga, Carbon, Wyoming, USA.

**1939**

Birth of Mary Elizabeth Kelley<sup>414</sup> on 2 January, in Carlisle, Kentucky, USA.  
 Birth of Jack Wayne Kennaday<sup>136</sup> on 15 December.  
 Birth of Nelson Chester Whitman<sup>174</sup> in BigPiney, Sublette, Wyoming, USA.

**1940**

Birth of Jimmy Ray Lott<sup>143</sup> on 22 March.  
 Death of Harry Otis Kennaday<sup>314</sup> on 25 April, in Cheyenne, Laramie, Wyoming, USA.  
 Death of Mable Pierce<sup>317</sup> on 27 May, in Saratoga, Carbon, Wyoming, USA.  
 Death of Charles Alonzo Kennaday<sup>329</sup> on 6 December, in Saratoga, Carbon, Wyoming, USA.  
 Birth of Carl L Kennaday<sup>302</sup> on 18 December, in Saratoga, Carbon, Wyoming, USA.  
 Birth of Boyd David Whitman<sup>178</sup> in BigPiney, Sublette, Wyoming, USA.  
 Birth of Norman Perry Curtis<sup>157</sup>.

**1941**

Birth of Richard Ward Whitman<sup>180</sup> in BigPiney, Sublette, Wyoming, USA.  
 Birth of Dorothy Lorraine Cairns<sup>298</sup> in Rawlins, Carbon, Wyoming, USA.

**1942**

Birth of Gary Forrest Kennaday<sup>138</sup> on 7 February.  
 Birth of Wanda Lou Kelley<sup>416</sup> on 22 February, in Carlisle, Kentucky, USA.  
 Birth of Joy L Kennaday<sup>304</sup> on 17 April, in Saratoga, Carbon, Wyoming, USA.  
 Birth of Sherry Jean Marier<sup>160</sup> on 22 November.  
 Birth of Robert Harry Rogerson<sup>192</sup>.  
 Death of Dorothy Lorraine Cairns<sup>298</sup>.

**1943**

Birth of Ronald David Kelley, Sr.<sup>154</sup> on 10 September, in Pueblo, Colorado, USA.  
 Birth of Garrett David Ackerson<sup>202</sup>.

**1944**

Birth of Donald Fay Kennaday<sup>306</sup> on 18 May, in Saratoga, Carbon, Wyoming, USA.  
 Birth of Charlotte Louise Whitman<sup>182</sup> in BigPiney, Sublette, Wyoming, USA.

**1945**

Birth of Jane Marie Marier<sup>163</sup> on 4 February.  
 Birth of Carolyn June Kelley<sup>156</sup> on 8 February, in Carlisle, Kentucky, USA.  
 Marriage of Ellen (Dude) Stockwell<sup>258</sup> and Forest Jack Kennaday<sup>257</sup> on 9 June.  
 Marriage of Lincoln Frank Kennaday<sup>266</sup> and Joan Olivia Debernardi<sup>267</sup> on 25 October.  
 Birth of Cristine Faye Kelley<sup>418</sup> on 9 December, in Carlisle, Kentucky, USA.  
 Birth of Edward J McCrea<sup>197</sup>.  
 Birth of Terry Walter Ackerson<sup>204</sup>.  
 Birth of Craig Martin Schmeling<sup>300</sup> in Whittemore, Platte, Wyoming, USA.

**1946**

Birth of Gary Jo Kennaday<sup>165</sup> on 4 March, in Roseburg, Douglas, Oregon, USA.  
 Birth of Marcella Ann Whitman<sup>184</sup>.  
 Birth of Kay Harding<sup>205</sup>.  
 Birth of Patricia Cox<sup>206</sup>.  
 Birth of Katheryne Louise Blackburn<sup>196</sup>.

**1946 (continued)**

Death of Mary Miranda Unknown<sup>597</sup>.  
 Birth of Judy Ann Cairns<sup>299</sup> in Rawlins, Carbon, Wyoming, USA.

**1947**

Birth of Betty Carol Fitzpatrick<sup>155</sup> on 14 April, in Paris, Bourbon, Kentucky, USA.  
 Birth of Wesley Cecil Ackerson<sup>207</sup>.

**1948**

Marriage of James Martin Marier<sup>265</sup> and Bonnie Jean Kennaday<sup>263</sup> on 6 April.  
 Marriage of John David Kelley<sup>262</sup> and Iva June Kennaday<sup>261</sup> on 8 August, in Flemmingburg, Kentucky, USA.  
 Birth of Evelyn Anderson<sup>203</sup>.  
 Birth of Phillis Lana Whitman<sup>186</sup>.  
 Birth of Wilma Elaine Rogerson<sup>193</sup>.  
 Birth of Danny Ray Ackerson<sup>209</sup>.

**1949**

Birth of David Debernardi Kennaday<sup>167</sup> on 8 January, in Roseburg, Douglas, Oregon, USA.  
 Birth of Ruth Orrine Rogerson<sup>194</sup>.  
 Birth of Daniel Clark Davidson<sup>200</sup>.

**1950**

Birth of Linda Ann Cairns<sup>226</sup>.  
 Birth of Ronald Otis Page<sup>227</sup> in Colorado Springs, ElPaso, Colorado, USA.  
 Birth of Nancy Sue Kurth<sup>210</sup>.

**1951**

Birth of Gary Scott<sup>383</sup> on 3 January.  
 Birth of Brenda Jane Kelley<sup>421</sup> on 25 August, in Carlisle, Kentucky, USA.  
 Death of Edward Thomas Kennaday<sup>318</sup> on 16 October.  
 Birth of Suellen Louise Davidson<sup>211</sup>.  
 Birth of Christine Marie Cairns<sup>228</sup> in Rawlins, Carbon, Wyoming, USA.

**1952**

Death of Nancy Alice Martindale<sup>502</sup> on 27 August, in Polk, Missouri, USA.  
 Birth of Laurel Alice Whitman<sup>188</sup>.

**1953**

Birth of James Luther Kelley, Jr.<sup>422</sup> on 14 February, in Carlisle, Kentucky, USA.  
 Birth of John Ellery Masters<sup>212</sup>.  
 Birth of Jack Lavoy Cairns, Jr.<sup>230</sup> in Rock Springs, Sweetwater, Wyoming, USA.  
 Birth of Richard Norman Wilson<sup>238</sup> in Rawlins, Carbon, Wyoming, USA.  
 Birth of Harvey David Blackburn<sup>198</sup>.  
 Birth of Paula Jo Smith<sup>168</sup> in Roseburg, Douglas, Oregon, USA.  
 Death of Robert Harry Rogerson<sup>192</sup>.

**1954**

Birth of Bobby Gene Kelley<sup>385</sup> on 8 August, in Carlisle, Kentucky, USA.  
 Birth of Freddie Warren Kelley<sup>423</sup> on 24 September, in Carlisle, Kentucky, USA.  
 Birth of Kenneth Logan Wilson<sup>239</sup> in Rawlins, Carbon, Wyoming, USA.  
 Birth of John Ellery Cooper<sup>237</sup> in Yonkers, New York, USA.  
 Birth of Elizabeth Kay Cairns<sup>232</sup> in Rawlins, Carbon, Wyoming, USA.  
 Birth of Jean Marie Davidson<sup>201</sup>.

**1955**

Death of Frank Forest Kennaday<sup>316</sup> on 11 November.  
 Birth of Donnie Lee Kelley<sup>424</sup> on 25 November, in Carlisle, Kentucky, USA.  
 Birth of Phyllis Ann Wilson<sup>240</sup> in Rawlins, Carbon, Wyoming, USA.  
 Birth of William Wayne Cairns<sup>234</sup> in Rawlins, Carbon, Wyoming, USA.  
 Birth of Craig Campbell<sup>229</sup>.  
 Birth of Rebecca Cassler<sup>231</sup>.  
 Birth of Kristy Lee Ary<sup>208</sup>.

**1956**

Birth of Steven Scott Kennaday<sup>169</sup> on 5 March, in Roseburg, Douglas, Oregon, USA.  
 Death of James Luther Kelley<sup>432</sup> on 27 March, in Carlisle, Kentucky, USA.  
 Death of Freddie Warren Kelley<sup>423</sup> on 4 November, in Carlisle, Kentucky, USA.  
 Death of Alice Mannahan<sup>319</sup>.  
 Birth of Catherine Susan Lavelle<sup>170</sup> in Van Nuys, California, USA.  
 Birth of James Vencent Boyd<sup>21</sup> in Cleveland, Ohio, USA.  
 Birth of Brigid Ann Young<sup>173</sup> in Burbank, Los Angeles, California, USA.  
 Birth of Rebecca Gay Cairns<sup>236</sup> in Rawlins, Carbon, Wyoming, USA.

**1957**

Birth of Fredrick Frank Kennaday<sup>172</sup> on 5 May, in Roseburg, Douglas, Oregon, USA.  
 Birth of Charles Whitman<sup>191</sup>.  
 Birth of Linda Hayes<sup>66</sup>.  
 Birth of Kae Porter<sup>235</sup> in Ceder City, Iron, Utah, USA.

**1958**

Birth of Brenda Sue Sobo<sup>20</sup> on 22 March, in Klamath, Falls, Klamath, Organ, USA.  
 Birth of Billy Dean Kelley<sup>425</sup> on 9 June, in Carlisle, Kentucky, USA.  
 Marriage of August Henry Geppert<sup>131</sup> and Patty Ray Kennaday<sup>130</sup> on 26 July.  
 Birth of Delera Kay Lott<sup>38</sup> on 8 November.  
 Death of John Harvey Sapp<sup>596</sup> on 18 December.  
 Death of John W Kennaday<sup>334</sup> on 19 December.  
 Birth of Toby Hayes<sup>70</sup>.

**1959**

Birth of Randy Eugene Sobo<sup>22</sup> on 7 July, in Medford, Jackson, Organ, USA.  
 Birth of Donna Scott<sup>384</sup> on 4 August.  
 Birth of Rosa e Mary Berryman<sup>395</sup> on 26 September.  
 Death of Anna Ruth Kennaday<sup>310</sup> on 6 November, in Ceder Vale, Chautauqua, Kansas, USA.  
 Birth of Robbyn Cherter Whitman<sup>87</sup>.

**1960**

Birth of Lori Ann Geppert<sup>28</sup> on 18 February, in Portland, Washington, Organd, USA.  
 Death of Millard Gulett<sup>377</sup> on 8 March, in Harrisburg, Mercer, Kentucky, USA.  
 Birth of Todd Kennaday<sup>33</sup> on 5 May, in Oregon.  
 Birth of Lee Ann Marie Lott<sup>42</sup> in August.  
 Birth of Teresa Lynn Sobo<sup>24</sup> on 19 August, in Medford, Jackson, Organ, USA.  
 Birth of John Frank Lott<sup>46</sup> on 23 September.  
 Death of Anne E D Kennaday<sup>335</sup> on 4 October.  
 Death of Anna Marshal<sup>338</sup> on 8 December, in Saratoga, Carbon, Wyoming, USA.  
 Birth of Kathy Ann Lott<sup>39</sup> on 12 December.  
 Birth of Peri Ann Whitman<sup>88</sup>.  
 Marriage of Thomas Eugene Kennaday<sup>128</sup> and Janice Benson<sup>129</sup> in Antonio, Texas.  
 Birth of Charles Noller Davidson<sup>216</sup>.  
 Birth of Gerald Noller Tomayer<sup>215</sup>.

**1961**

Death of Mary Elizabeth Minton<sup>443</sup> on 26 January, in Carlisle, Kentucky, USA.  
 Death of Betty Jack Osburn<sup>376</sup> in April, in Northmiddle Town, Kentucky, USA.  
 Birth of Gilbert Berryman<sup>396</sup> on 20 April.  
 Birth of Karla Lynn Kennaday<sup>26</sup> on 8 July, in Vallejo, Napa, Califorina, USA.  
 Death of Charles Fredrick Kennaday<sup>322</sup> on 6 December.  
 Marriage of John Jennings<sup>305</sup> and Joy L Kennaday<sup>304</sup>.

**1962**

Birth of Julie Mae Berryman<sup>397</sup> on 2 June.  
 Birth of Calvin E Terett Lott<sup>43</sup> in July.  
 Birth of Gordon Scott (Scotty) Johnson<sup>82</sup> on 10 August.  
 Birth of Randy Eugene Lott<sup>153</sup> on 29 December.  
 Birth of Kathy Kay Kennaday<sup>27</sup> in Vallejo, Napa, Califorina, USA.  
 Birth of Judy Arlene Geppert<sup>30</sup> in Portland, Washington, Organd, USA.  
 Birth of Karen Hayes<sup>71</sup>.  
 Birth of Joyce Ellen Jorgensen<sup>34</sup> in Phoenix, Orange, Arizona, USA.  
 Birth of Richard Lee Wells<sup>219</sup>.  
 Birth of Marcus Pine Whitman<sup>474</sup>.  
 Birth of Marcus Pine Whitman<sup>89</sup>.  
 Birth of Lorraine Madden<sup>177</sup>.

**1963**

Marriage of Norman Perry Curtis<sup>157</sup> and Carolyn June Kelley<sup>156</sup> on 12 January, in Carlisle, Kentucky, USA.  
 Marriage of Ronald David Kelley, Sr.<sup>154</sup> and Betty Carol Fitzpatrick<sup>155</sup> on 6 April, in Carlisle, Kentucky, USA.  
 Death of Julie Mae Berryman<sup>397</sup> on 3 September.  
 Birth of Diana Lott<sup>47</sup> on 13 September.  
 Birth of Freda Jean Berryman<sup>398</sup> on 14 September.  
 Marriage of Charles Raymond Thompson<sup>371</sup> and Sandra Darlene Fitzpatrick<sup>370</sup> in November.  
 Birth of Lisa June Kelley<sup>52</sup> on 18 December, in Carlisle, Kentucky, USA.  
 Birth of Celeste Marie Hoffman<sup>199</sup>.

**1963 (continued)**

Birth of Keren Lynne Harned<sup>218</sup>.  
 Birth of Tori Dawn Bartlett<sup>95</sup>.

**1964**

Birth of Donna Denice Thompson<sup>361</sup> on 6 January, in Huntsville, Alabama, USA.  
 Death of Donna Denice Thompson<sup>361</sup> on 18 February, in Huntsville, Alabama, USA.  
 Birth of Darren Kennaday<sup>35</sup> on 19 February.  
 Birth of Anita Carol Curtis<sup>62</sup> on 9 April, in Carlisle, Nicholas, Kentucky, USA.  
 Birth of MAnnett Marie Lott<sup>40</sup> on 4 June.  
 Birth of Tommy Berryman, II<sup>399</sup> on 3 September.  
 Birth of Anna Carol Kelley<sup>56</sup> on 27 November.  
 Birth of Tommy Duane Geppert<sup>32</sup> in Portland, Washington, Oregon, USA.

**1965**

Death of William Allen Fitzpatrick<sup>375</sup> on 12 March, in Northmiddle Town, Kentucky, USA.  
 Birth of Stanley (Stan) Johnson<sup>83</sup> on 14 June.  
 Birth of Katy Sue Blunt<sup>44</sup> on 21 June.  
 Birth of Kelly Michele Kennaday<sup>36</sup> on 9 July.  
 Marriage of Robert Therman Williams<sup>368</sup> and Tempie Ann Fitzpatrick<sup>366</sup> on 27 November.  
 Death of Wilma Elaine Rogerson<sup>193</sup>.  
 Birth of Kathleen Marie Redman<sup>220</sup>.

**1966**

Birth of Mike Allen Forrester, Jr.<sup>84</sup> on 22 January.  
 Birth of Roxy Ann Lott<sup>41</sup> on 24 January.  
 Birth of Ronald David Kelley, Jr.<sup>58</sup> on 9 June, in Lexington, Kentucky, USA.  
 Birth of Norman Perry Curtis, Jr.<sup>67</sup> on 28 August, in Indianapolis, Marion, Indiana, USA.  
 Birth of Bradly Tommy Thompson<sup>98</sup>.

**1967**

Marriage of Cecil Ray Montgomery<sup>373</sup> and Virginia Ruth Gulett<sup>374</sup> on 3 February.  
 Birth of Michele Lott<sup>48</sup> in June.  
 Birth of Jeffrey Michael Kennaday<sup>37</sup> on 26 September.  
 Birth of Grant Douglas Whitman<sup>93</sup>.  
 Birth of Fred Winton Smith<sup>99</sup>.  
 Death of Fairfax Harry Davidson<sup>321</sup>.

**1968**

Birth of Tommy James Forrester<sup>85</sup> on 4 May.  
 Death of Logan Turner Cairns<sup>325</sup>.  
 Birth of Gail Robin Whitman<sup>94</sup>.  
 Birth of Micheal Gerald Sturm Whitman<sup>90</sup>.

**1969**

Birth of Collin Wade Whitman<sup>100</sup>.  
 Birth of Travis Darryl Bartlett<sup>96</sup>.  
 Birth of Patrick Keith Whitman<sup>91</sup>.

**1970**

Birth of Melony Jo Curtis<sup>69</sup> on 14 January, in Indianapolis, Marion, Indiana, USA.  
 Death of John David Kelley<sup>262</sup> on 21 April, in Carlisle, Kentucky, USA.  
 Death of Melony Jo Curtis<sup>69</sup> on 8 December, in Indianapolis, Marion, Indiana, USA.  
 Birth of Kathryn Victoria Redman<sup>224</sup>.

**1971**

Birth of Thomas Elliott Page<sup>104</sup> in Ogden, Weber, Utah, USA.

**1972**

Marriage of Ronald Lee Abner<sup>369</sup> and Tempie Ann Fitzpatrick<sup>366</sup> on 4 July.  
 Death of Mary Lou Kennaday<sup>270</sup>.

**1973**

Birth of David Earl Curtis<sup>72</sup> on 17 April, in Indianapolis, Marion, Indiana, USA.  
 Birth of Johnathan Jack Page<sup>105</sup> in Rawlins, Carbon, Wyoming, USA.  
 Birth of Nathanielle Rebecca Whitman<sup>92</sup>.

**1974**

Death of Fay Kennaday<sup>328</sup> on 23 May.  
 Birth of Ronnie Wesley Redman<sup>225</sup>.  
 Birth of Trevor David Bartlett<sup>97</sup>.  
 Marriage of Carl L Kennaday<sup>302</sup> and Carol Brugus<sup>303</sup>.  
 Birth of Stuart Branson Self<sup>101</sup>.



**1975**

Birth of Donald Grant Page<sup>106</sup> in Rawlins, Carbon, Wyoming, USA.  
 Birth of Kreetta Ann Jebens<sup>123</sup> in Rawlins, Carbon, Wyoming, USA.  
 Birth of Ian Mathew Self<sup>102</sup>.  
 Birth of Jeremy Alan Hansen<sup>112</sup> in Craig, Moffat, Colorado, USA.

**1976**

Birth of Aaron Wayne Hansen<sup>113</sup> in Idaho Falls, Bonneville, Idaho, USA.  
 Birth of Tyler Martin Schmeling<sup>242</sup> in Weatland, Platte, Wyoming, USA.

**1977**

Birth of Ashley Chester Self<sup>103</sup>.  
 Birth of Steve Hix<sup>121</sup>.  
 Birth of Tiffany Anne Cooper<sup>120</sup> in Logan, Cache, Utah, USA.  
 Birth of Korey Kay Jebens<sup>124</sup> in Rawlins, Carbon, Wyoming, USA.

**1978**

Death of Edward S (Pete) Fitzpatrick<sup>372</sup> on 8 November, in Bourbon, Kentucky, USA.  
 Birth of Nicholas Isaiah Kennaday<sup>74</sup> in Roseburg, Douglas, Oregon, USA.  
 Birth of Triana Marie Campbell<sup>107</sup> in Salt Lake City, Salt Lake, Utah, USA.  
 Birth of Hillary Ranee Cooper<sup>122</sup> in Logan, Cache, Utah, USA.  
 Birth of Amy Nichole Schmeling<sup>243</sup> in Cheyenne, Laramie, Wyoming, USA.

**1979**

Death of Alice Oda May Kennaday<sup>320</sup> on 6 December, in Rawlins, Carbon, Wyoming, USA.  
 Birth of Rachel Elizabeth Cairns<sup>110</sup>.  
 Birth of Michael Brent Hansen<sup>114</sup> in Idaho Falls, Bonneville, Idaho, USA.  
 Birth of Patricia Leigh Kennaday<sup>80</sup> in San Diego, San Diego, California, USA.  
 Birth of Carlie Norman Jebens<sup>125</sup> in Rawlins, Carbon, Wyoming, USA.

**1980**

Birth of Clarence Bland Kennedy<sup>495</sup> on 9 April, in Ceder Vale, Chautauqua, Kansas, USA.  
 Birth of Elizabeth Alta Olivia Kennaday<sup>75</sup> in Roseburg, Douglas, Oregon, USA.  
 Birth of Holly Ann Campbell<sup>108</sup> in Salt Lake City, Salt Lake, Utah, USA.

**1981**

Birth of Anthony Joseph Kennaday<sup>81</sup> in Roseburg, Douglas, Oregon, USA.  
 Birth of Amy Nicole Hansen<sup>115</sup> in Idaho Falls, Bonneville, Idaho, USA.

**1982**

Marriage of Cristian Hunnicutt<sup>53</sup> and Lisa June Kelley<sup>52</sup> on 13 February, in Indianapolis, Indiana, USA.  
 Birth of Justin Kyle Sobo<sup>3</sup> in Medford, Jackson, Organ, USA.  
 Birth of Cristina Dianne Kennaday<sup>76</sup> in Roseburg, Douglas, Oregon, USA.  
 Birth of Joshua Jolin Kennaday<sup>77</sup> in Glide, Douglas, Oregon, USA.

**1983**

Birth of Christian David Hunnicutt<sup>9</sup> on 10 January, in Indianapolis, Indiana, USA.  
 Marriage of Gregory Wert<sup>57</sup> and Anna Carol Kelley<sup>56</sup> on 28 May, in Indianapolis, Indiana, USA.  
 Death of Loyd Andrew Kennaday<sup>326</sup> on 10 December.  
 Birth of Jacob Karl Hansen<sup>116</sup> in Idaho Falls, Bonneville, Idaho, USA.  
 Birth of Mary Melissa Cairns<sup>111</sup>.  
 Birth of Dorci Kae Cairns<sup>117</sup> in Idaho Falls, Bonneville, Idaho, USA.

**1984**

Marriage of Mike Phelps<sup>65</sup> and Anita Carol Curtis<sup>62</sup> on 27 August.

**1985**

Death of Alice Ann Kennaday<sup>274</sup>.  
 Birth of Julie Erin Sobo<sup>4</sup> in Medford, Jackson, Organ, USA.  
 Birth of Eric Raymond Campbell<sup>109</sup> in Salt Lake City, Salt Lake, Utah, USA.

**1987**

Marriage of Mark Meyer<sup>60</sup> and Sherrie (Like a Daughter) Jones<sup>59</sup> in November.  
 Birth of Travis Andrew Sobo<sup>5</sup> in Medford, Jackson, Organ, USA.  
 Birth of Tyler Jamison Sobo<sup>6</sup> in Medford, Jackson, Organ, USA.  
 Birth of Adam Malaki Kennaday<sup>7</sup> in Anaheim, Orange, Calafornia, USA.

**1988**

Death of Emma Helen Kennaday<sup>324</sup> on 26 August, in Rawlins, Carbon, Wyoming, USA.  
 Birth of Jace William Cairns<sup>118</sup> in Idaho Falls, Bonneville, Idaho, USA.

**1990**

Marriage of James Mickel Asbury<sup>54</sup> and Lisa June Kelley<sup>52</sup> on 26 May, in Cynthiana, Scott, Kentucky, USA.  
Birth of Aaron Forest Kennaday<sup>8</sup> in Anaheim, Orange, California, USA.  
Death of Robert Therman Williams<sup>368</sup>.  
Death of Gladys Eleanor Ream<sup>253</sup>.

**1991**

Birth of James Mathew Asbury<sup>10</sup> on 28 June, in Lexington, Kentucky, USA.  
Death of Inez Henderson<sup>327</sup> on 22 September, in Saratoga, Carbon, Wyoming, USA.  
Birth of Brindi Michelle Cairns<sup>119</sup> in Idaho Falls, Bonneville, Idaho, USA.

**1992**

Birth of Caitlin Arlena Boyd<sup>1</sup> in Manaqua, Nicaragua.

**1993**

Death of Carolyn June Kelley<sup>156</sup> on 25 July.

**1994**

Birth of Mercedes Curtis<sup>17</sup> in August, in Indianapolis, Marion, Indiana, USA.  
Birth of Jason Alexander Boyd<sup>2</sup>.

**1995**

Birth of Savanna June Curtis<sup>18</sup> on 14 June, in Indianapolis, Marion, Indiana, USA.  
Death of Carlie Norman Jebens<sup>125</sup>.

**1996**

Marriage of David Earl Curtis<sup>72</sup> and Toni Benner<sup>73</sup> on 7 July.  
Birth of Ivie Ski Curtis<sup>19</sup> on 11 November.  
Death of Charles Leroy Stewart<sup>250</sup>.

**1997**

Death of Ronald David Kelley, Jr.<sup>58</sup> on 15 September, in Indianapolis, Marion, Indiana, USA.

**1999**

Death of James Martin Marier<sup>265</sup>.

**2005**

Death of Iva June Kennaday<sup>261</sup> on 16 March, in Indianapolis, Indiana, USA.

**2007**

Death of Virginia Ruth Gulett<sup>374</sup> on 21 January, in Holiday, Pasco, Florida, USA.

## 17. INDEX OF INDIVIDUALS

<u>Ref.</u>	<u>Tree</u>	<u>Name (Relationship)</u>
437		WATKINS, Efrfie Mae (John David Kelley's cousin).
448		..... Mr. (John David Kelley's uncle by marriage).
358		ABNER, Jamie Christene (Betty Carol Fitzpatrick's niece).
369		..... Ronald Lee (Betty Carol Fitzpatrick's brother-in-law).
357		..... Ronald Lee, Jr. (Betty Carol Fitzpatrick's nephew).
209	56	ACKERSON, Danny Ray (James's great-great-great-grandson).
202	56	..... Garrett David (James's great-great-great-grandson).
204	56	..... Terry Walter (James's great-great-great-grandson).
286	56	..... Walter Cecil (James's great-great-granddaughter's husband).
207	56	..... Wesley Cecil (James's great-great-great-grandson).
203		ANDERSON, Evelyn (James's great-great-great-grandson's wife).
569		..... Mattie (Anne Elizabeth Van Orsdel's sister-in-law).
538		ANKROM, Clementine (Frances Elizabeth Kennedy's aunt).
536		..... Elizabeth (Frances Elizabeth Kennedy's aunt).
542		..... John (Frances Elizabeth Kennedy's grandfather).
531		..... John Ellery (Frances Elizabeth Kennedy's uncle).
548		..... Joseph (Frances Elizabeth Kennedy's great-grandfather).
533		..... Martha Ann (Frances Elizabeth Kennedy's aunt).
532		..... Mary Ann (Frances Elizabeth Kennedy's aunt).
537		..... Miriah (Frances Elizabeth Kennedy's aunt).
529		..... Richard (Frances Elizabeth Kennedy's uncle).
515		..... Sarah Ann (Frances Elizabeth Kennedy's mother).
530		..... Solomon (Frances Elizabeth Kennedy's uncle).
539		..... Thomas (Frances Elizabeth Kennedy's uncle).
535		..... Uriah (Frances Elizabeth Kennedy's uncle).
534		..... William (Frances Elizabeth Kennedy's uncle).
546		..... William (Frances Elizabeth Kennedy's great-grandfather).
208		ARY, Kristy Lee (James's great-great-great-grandson's wife).
10	5	ASBURY, James Mathew (James's five-times-great-grandson).
54	5	..... James Mickel (James's four-times-great-granddaughter's husband).
11	5	..... Liam Joseph (James's five-times-great-grandson).
504		BACUS, Effie (Frances Elizabeth Kennedy's sister-in-law).
183	33	BARTLETT, Joseph Grant (James's great-great-great-granddaughter's husband).
95	33	..... Tori Dawn (James's four-times-great-granddaughter).
96	33	..... Travis Darryl (James's four-times-great-grandson).
97	33	..... Trevor David (James's four-times-great-grandson).
323	68	BAYS, Margaret (James's great-grandson's wife).
73	8	BENNER, Toni (James's four-times-great-grandson's wife).
129	10	BENSON, Janice (James's great-great-great-grandson's wife).
398		BERRYMAN, Freda Jean (John David Kelley's great-niece).
396		..... Gilbert (John David Kelley's great-nephew).
397		..... Julie Mae (John David Kelley's great-niece).
395		..... Rosa e Mary (John David Kelley's great-niece).
417		..... Tommy (John David Kelley's niece's husband).
399		..... Tommy, II (John David Kelley's great-nephew).
282	54	BLACKBURN, Harvey Alton (James's great-great-granddaughter's husband).
198	54	..... Harvey David (James's great-great-great-grandson).
196	54	..... Katheryne Louize (James's great-great-great-granddaughter).
146	18	BLUNT, Al (James's great-great-great-granddaughter's husband).
45	18	..... Ed (James's four-times-great-grandson).
44	18	..... Katy Sue (James's four-times-great-granddaughter).
586		BOICE, Ephriam (Anne Elizabeth Van Orsdel's grandfather).
576		..... Jacob (Anne Elizabeth Van Orsdel's uncle).
574		..... Katie (Anne Elizabeth Van Orsdel's aunt).
572		..... Mary B (Anne Elizabeth Van Orsdel's aunt).
571		..... Rebecca K (Anne Elizabeth Van Orsdel's mother).
465		BOWLES, Amelia Frances (John David Kelley's grandmother).
1	1	BOYD, Caitlin Arlena (James's five-times-great-granddaughter).
21	1	..... James Vencent (James's four-times-great-granddaughter's husband).
2	1	..... Jason Alexander (James's five-times-great-grandson).
356		BRANDENBURG, Casey (Betty Carol Fitzpatrick's niece's husband).
137	14	BRANT, Carol Lee (James's great-great-great-grandson's wife).

<u>Ref.</u>	<u>Tree</u>	<u>Name (Relationship)</u>
255		BRAY, Mr. (James's great-great-granddaughter's husband).
303		BRUGUS, Carol (James's great-great-grandson's wife).
119	41	CAIRNS, Brindi Michelle (James's four-times-great-granddaughter).
228	60	..... Christine Marie (James's great-great-great-granddaughter).
117	41	..... Dorci Kae (James's four-times-great-granddaughter).
298	69	..... Dorothy Lorraine (James's great-great-granddaughter).
279		..... Douglas Turner (James's great-great-granddaughter's husband).
232	60	..... Elizabeth Kay (James's great-great-great-granddaughter).
118	41	..... Jace William (James's four-times-great-grandson).
294	69	..... Jack Lavoy (James's great-great-grandson).
230	60	..... Jack Lavoy, Jr. (James's great-great-great-grandson).
299	69	..... Judy Ann (James's great-great-granddaughter).
226	60	..... Linda Ann (James's great-great-great-granddaughter).
325	69	..... Logan Turner (James's great-granddaughter's husband).
296	69	..... Margaret Faunita (James's great-great-granddaughter).
111	39	..... Mary Melissa (James's four-times-great-granddaughter).
110	39	..... Rachel Elizabeth (James's four-times-great-granddaughter).
236	60	..... Rebecca Gay (James's great-great-great-granddaughter).
234	60	..... William Wayne (James's great-great-great-grandson).
229	38	CAMPBELL, Craig (James's great-great-great-granddaughter's husband).
109	38	..... Eric Raymond (James's four-times-great-grandson).
108	38	..... Holly Ann (James's four-times-great-granddaughter).
107	38	..... Triana Marie (James's four-times-great-granddaughter).
231	39	CASSLER, Rebecca (James's great-great-great-grandson's wife).
552		CATTERSON, Sarah (Anne Elizabeth Van Orsdel's sister-in-law).
195		CAYLOR, Roger (James's great-great-great-granddaughter's husband).
25		CLARIDGE, Tom (James's four-times-great-granddaughter's husband).
139		COOPTON, Vicki (James's great-great-great-grandson's wife).
122	42	COOPER, Hillary Rane (James's four-times-great-granddaughter).
237	42	..... John Ellery (James's great-great-great-granddaughter's husband).
120	42	..... Tiffany Anne (James's four-times-great-granddaughter).
176	30	CORLETT, Claudette Irene (James's great-great-great-grandson's wife).
475		..... Claudette Irene (Bruce Douglas Whitman's wife).
190		..... Everett Michael (James's great-great-great-granddaughter's husband).
420		COX, Mr. (John David Kelley's niece's husband).
206		..... Patricia (James's great-great-great-grandson's wife).
62	22	CURTIS, Anita Carol (James's four-times-great-granddaughter).
72	22	..... David Earl (James's four-times-great-grandson).
19	8	..... Ivie Ski (James's five-times-great-granddaughter).
69	22	..... Melony Jo (James's four-times-great-granddaughter).
17	8	..... Mercedes (James's five-times-great-granddaughter).
157	22	..... Norman Perry (James's great-great-great-granddaughter's husband).
67	22	..... Norman Perry, Jr. (James's four-times-great-grandson).
18	8	..... Savanna June (James's five-times-great-granddaughter).
284	55	DADISMAN, Norma Hilda (James's great-great-grandson's wife).
287	67	DAVIDSON, Charles Daniel (James's great-great-grandson).
216	57	..... Charles Noller (James's great-great-great-grandson).
283	67	..... Chester Clark (James's great-great-grandson).
200	55	..... Daniel Clark (James's great-great-great-grandson).
213	57	..... Deborah Jeane (James's great-great-great-granddaughter).
285	67	..... Eleanora Alice (James's great-great-granddaughter).
321	67	..... Fairfax Harry (James's great-granddaughter's husband).
275	67	..... Frances Amonda (James's great-great-granddaughter).
201	55	..... Jean Marie (James's great-great-great-granddaughter).
281	67	..... Louize Gertrude (James's great-great-granddaughter).
289	67	..... Myrtle Rae (James's great-great-granddaughter).
211	57	..... Suellen Louise (James's great-great-great-granddaughter).
277	67	..... Vita Maude (James's great-great-granddaughter).
267	51	DEBERNARDI, Joan Olivia (James's great-great-grandson's wife).
563		DIEHL, Noah (Anne Elizabeth Van Orsdel's brother-in-law).
144	17	DOLLAR HYDE, Ellen (James's great-great-great-grandson's wife).
547		EAGOR, Mary (Frances Elizabeth Kennedy's great-grandmother).

<u>Ref.</u>	<u>Tree</u>	<u>Name (Relationship)</u>
435		EARLYWINE, Betty (John David Kelley's sister-in-law).
222		FERRIN, Richard (James's great-great-great-granddaughter's husband).
354		FITZPATRICK, A J (Betty Carol Fitzpatrick's nephew).
155	21	..... Betty Carol (James's great-great-great-grandson's wife).
372		..... Edward S (Pete) (Betty Carol Fitzpatrick's father).
370		..... Sandra Darlene (Betty Carol Fitzpatrick's sister).
352		..... Tammy Lynn (Betty Carol Fitzpatrick's niece).
366		..... Tempie Ann (Betty Carol Fitzpatrick's sister).
351		..... Terri Lyn (Betty Carol Fitzpatrick's niece).
353		..... Virginia Ruth (Betty Carol Fitzpatrick's niece).
375		..... William Allen (Betty Carol Fitzpatrick's grandfather).
362		..... William Terry (Betty Carol Fitzpatrick's brother).
86	24	FORRESTER, Jamie (James's four-times-great-granddaughter).
164	24	..... Micheal A (James's great-great-great-granddaughter's husband).
84	24	..... Mike Allen, Jr. (James's four-times-great-grandson).
85	24	..... Tommy James (James's four-times-great-grandson).
131	11	GEPPERT, August Henry (James's great-great-great-granddaughter's husband).
30	11	..... Judy Arlene (James's four-times-great-granddaughter).
28	11	..... Lori Ann (James's four-times-great-granddaughter).
32	11	..... Tommy Duane (James's four-times-great-grandson).
367		GLIPSEY, Johnny (Betty Carol Fitzpatrick's brother-in-law).
379		GULETT, John W (Betty Carol Fitzpatrick's great-grandfather).
377		..... Millard (Betty Carol Fitzpatrick's grandfather).
374		..... Virginia Ruth (Betty Carol Fitzpatrick's mother).
113	40	HANSEN, Aaron Wayne (James's four-times-great-grandson).
233	40	..... Alan (James's great-great-great-granddaughter's husband).
115	40	..... Amy Nicole (James's four-times-great-granddaughter).
116	40	..... Jacob Karl (James's four-times-great-grandson).
112	40	..... Jeremy Alan (James's four-times-great-grandson).
114	40	..... Michael Brent (James's four-times-great-grandson).
205		HARDING, Kay (James's great-great-great-grandson's wife).
290	58	HARNED, David Debernardi (James's great-great-granddaughter's husband).
218	58	..... Keren Lynne (James's great-great-great-granddaughter).
61	13	HAYES, Bob (James's four-times-great-grandson).
135	13	..... Bob (James's great-great-great-granddaughter's husband).
71	13	..... Karen (James's four-times-great-granddaughter).
66	13	..... Linda (James's four-times-great-granddaughter).
70	13	..... Toby (James's four-times-great-grandson).
327	70	HENDERSON, Inez (James's great-grandson's wife).
558		HEWITT, William B (Anne Elizabeth Van Orsdel's brother-in-law).
121		HIX, Steve (James's four-times-great-granddaughter's husband).
199		HOFFMAN, Celeste Marie (James's great-great-great-grandson's wife).
133	12	HUBBARD, Rosa L (James's great-great-great-grandson's wife).
349	74	HUDSON, Sarah (James's wife).
9	4	HUNNICUTT, Christian David (James's five-times-great-grandson).
53	4	..... Cristian (James's four-times-great-granddaughter's husband).
381		HUTCHCHISON, Andy (Betty Carol Fitzpatrick's great-grandfather).
378		..... Cora Elizabeth (Betty Carol Fitzpatrick's grandmother).
523		JARVIS, Lydia (Frances Elizabeth Kennedy's aunt by marriage).
241	43	JEBENS, Carlie (James's great-great-great-granddaughter's husband).
125	43	..... Carlie Norman (James's four-times-great-grandson).
124	43	..... Korey Kay (James's four-times-great-granddaughter).
123	43	..... Kreetta Ann (James's four-times-great-granddaughter).
217		JENKINS, Tonia (James's great-great-great-grandson's wife).
305		JENNINGS, John (James's great-great-granddaughter's husband).
295	60	JOHNSON, Beverly Ann (James's great-great-grandson's wife).
162	23	..... Gordon (James's great-great-great-granddaughter's husband).
264	49	..... Gordon (James's great-great-granddaughter's husband).
82	23	..... Gordon Scott (Scotty) (James's four-times-great-grandson).
23	2	..... Kim Eileen (James's four-times-great-grandson's wife).
467		..... Margaret (John David Kelley's grandmother).
159	49	..... Scott (James's great-great-great-grandson).

<u>Ref.</u>	<u>Tree</u>	<u>Name (Relationship)</u>
158	49	JOHNSON, Stanley (James's great-great-great-grandson).
83	23	..... Stanley (Stan) (James's four-times-great-grandson).
221		..... Timothy Tol (James's great-great-great-granddaughter's husband).
59	21	JONES, Sherrie (Like a Daughter) (James's four-times-great-granddaughter).
34	3	JORGENSEN, Joyce Ellen (James's four-times-great-grandson's wife).
181	32	JOUETT, Robin Knipp (James's great-great-great-grandson's wife).
405		KELLEY, Amanda (John David Kelley's great-niece).
56	21	..... Anna Carol (James's four-times-great-granddaughter).
429		..... Aquilla David (John David Kelley's nephew).
436		..... Aquilla Durham (John David Kelley's brother).
449		..... Betty Jane (John David Kelley's aunt).
431		..... Beverly (John David Kelley's niece).
425		..... Billy Dean (John David Kelley's nephew).
406		..... Billy Dean (John David Kelley's great-nephew).
385		..... Bobby Gene (John David Kelley's great-nephew).
421		..... Brenda Jane (John David Kelley's niece).
156	48	..... Carolyn June (James's great-great-great-granddaughter).
418		..... Cristine Faye (John David Kelley's niece).
424		..... Donnie Lee (John David Kelley's nephew).
407		..... Dorthy Mae (John David Kelley's niece).
472		..... Edward (John David Kelley's great-great-great-grandfather).
470		..... Erasmus E (John David Kelley's great-great-grandfather).
409		..... Eugene (John David Kelley's nephew).
423		..... Freddie Warren (John David Kelley's nephew).
445		..... Herbert (John David Kelley's uncle).
446		..... Herman (John David Kelley's uncle).
432		..... James Luther (John David Kelley's brother).
422		..... James Luther, Jr. (John David Kelley's nephew).
262	48	..... John David (James's great-great-granddaughter's husband).
411		..... Juanita (John David Kelley's niece).
464		..... Lewis Lute (John David Kelley's grandfather).
52	21	..... Lisa June (James's four-times-great-granddaughter).
598		..... Lou (Betty Earlywine's mother).
447		..... Mabel (John David Kelley's aunt).
414		..... Mary Elizabeth (John David Kelley's niece).
430		..... Mary Lou (John David Kelley's niece).
428		..... Mildred Ann (John David Kelley's niece).
444		..... Milton Varso (John David Kelley's uncle).
58	21	..... Ronald David, Jr. (James's four-times-great-grandson).
154	48	..... Ronald David, Sr. (James's great-great-great-grandson).
450		..... Silverine (John David Kelley's aunt).
442		..... Talmadge Blane (John David Kelley's father).
434		..... Talmadge Blane, Jr. (John David Kelley's brother).
416		..... Wanda Lou (John David Kelley's niece).
427		..... William Blaine (John David Kelley's nephew).
468		..... William S (John David Kelley's great-grandfather).
8	3	KENNADAY, Aaron Forest (James's five-times-great-grandson).
7	3	..... Adam Malaki (James's five-times-great-grandson).
346	74	..... Alice (James's daughter).
274	66	..... Alice Ann (James's great-great-granddaughter).
320	71	..... Alice Oda May (James's great-granddaughter).
312	71	..... Alonso (James's great-grandson).
337	73	..... Andrew Jackson (James's grandson).
310	71	..... Anna Ruth (James's great-granddaughter).
335	73	..... Anne E D (James's granddaughter).
81	28	..... Anthony Joseph (James's four-times-great-grandson).
345	74	..... Axie (James's daughter).
263	65	..... Bonnie Jean (James's great-great-granddaughter).
302	70	..... Carl L (James's great-great-grandson).
271	66	..... Catherine Marie (James's great-great-granddaughter).
329	73	..... Charles Alonzo (James's grandson).
322	71	..... Charles Fredrick (James's great-grandson).

<u>Ref.</u>	<u>Tree</u>	<u>Name (Relationship)</u>
126	44	KENNADAY, Charlotte Arlene (James's great-great-great-granddaughter).
76	25	..... Cristina Dianne (James's four-times-great-granddaughter).
35	14	..... Darren (James's four-times-great-grandson).
167	51	..... David Debernardi (James's great-great-great-grandson).
306	70	..... Donald Fay (James's great-great-grandson).
318	71	..... Edward Thomas (James's great-grandson).
75	25	..... Elizabeth Alta Olivia (James's four-times-great-granddaughter).
336	73	..... Emma H (James's granddaughter).
324	71	..... Emma Helen (James's great-granddaughter).
328	72	..... Fay (James's great-granddaughter).
254	65	..... Florence Mae (James's great-great-granddaughter).
257	65	..... Forest Jack (James's great-great-grandson).
292	68	..... Frances Ann (James's great-great-granddaughter).
316	71	..... Frank Forest (James's great-grandson).
272	66	..... Fred E (James's great-great-grandson).
172	51	..... Fredrick Frank (James's great-great-great-grandson).
138	46	..... Gary Forrest (James's great-great-great-grandson).
165	51	..... Gary Jo (James's great-great-great-grandson).
314	71	..... Harry Otis (James's great-grandson).
313	71	..... Henry George (James's great-grandson).
332	73	..... Ida Jane (James's granddaughter).
261	65	..... Iva June (James's great-great-granddaughter).
301	70	..... Jack J (James's great-great-grandson).
136	46	..... Jack Wayne (James's great-great-great-grandson).
348	74	..... James (The subject of this report).
273	66	..... James (James's great-great-grandson).
331	73	..... James Edward (James's grandson).
37	16	..... Jeffrey Michael (James's four-times-great-grandson).
269	66	..... John E (James's great-great-grandson).
340	74	..... John Hudson (James's son).
334	73	..... John W (James's grandson).
339	74	..... Joseph Bryson (James's son).
347	74	..... Joseph Wright (James's son).
77	26	..... Joshua Jolin (James's four-times-great-grandson).
304	70	..... Joy L (James's great-great-granddaughter).
26	10	..... Karla Lynn (James's four-times-great-granddaughter).
27	10	..... Kathy Kay (James's four-times-great-granddaughter).
36	15	..... Kelly Michele (James's four-times-great-granddaughter).
266	65	..... Lincoln Frank (James's great-great-grandson).
326	72	..... Loyd Andrew (James's great-grandson).
78	27	..... Mallory (James's four-times-great-granddaughter).
270	66	..... Mary Lou (James's great-great-granddaughter).
333	73	..... Mary V (James's granddaughter).
343	74	..... Mary Vicker (James's daughter).
141	46	..... Michael Joseph (James's great-great-great-grandson).
74	25	..... Nicholas Isaiah (James's four-times-great-grandson).
80	28	..... Patricia Leigh (James's four-times-great-granddaughter).
130	44	..... Patty Ray (James's great-great-great-granddaughter).
344	74	..... Rachel A (James's daughter).
79	27	..... Reed (James's four-times-great-grandson).
308	71	..... Rosa Marie (James's great-granddaughter).
259	65	..... Rose Marie (James's great-great-granddaughter).
307	71	..... Sarah Elizabeth (James's great-granddaughter).
169	51	..... Steven Scott (James's great-great-great-grandson).
252	65	..... Thomas Earl (James's great-great-grandson).
128	44	..... Thomas Eugene (James's great-great-great-grandson).
33	14	..... Todd (James's four-times-great-grandson).
268	66	..... William C (James's great-great-grandson).
342	74	..... Zarilda (James's daughter).
487		KENNEDY, Addie (Frances Elizabeth Kennedy's niece).
484		..... Alvin (Frances Elizabeth Kennedy's nephew).
503		..... Andrew (Frances Elizabeth Kennedy's brother).

<u>Ref.</u>	<u>Tree</u>	<u>Name (Relationship)</u>
485		KENNEDY, Bearthey (Frances Elizabeth Kennedy's nephew).
518		..... Christine (Frances Elizabeth Kennedy's aunt).
495		..... Clarence Bland (Frances Elizabeth Kennedy's nephew).
483		..... Eddie (Frances Elizabeth Kennedy's nephew).
527		..... Elizabeth (Frances Elizabeth Kennedy's aunt).
497		..... Emaline (Frances Elizabeth Kennedy's sister).
524		..... Emiline (Frances Elizabeth Kennedy's aunt).
330	71	..... Frances Elizabeth (James's grandson's wife).
490		..... Fredrick Fay (Frances Elizabeth Kennedy's nephew).
510		..... George Washington (Frances Elizabeth Kennedy's brother).
519		..... Jacob (Frances Elizabeth Kennedy's uncle).
507		..... James Franklin (Frances Elizabeth Kennedy's brother).
520		..... James Leighton (Frances Elizabeth Kennedy's uncle).
488		..... Jesse Rufus (Frances Elizabeth Kennedy's nephew).
514		..... Jesse Rufus (Frances Elizabeth Kennedy's father).
540		..... John (Frances Elizabeth Kennedy's grandfather).
501		..... John Ronnie (Frances Elizabeth Kennedy's brother).
522		..... Jonn (Frances Elizabeth Kennedy's uncle).
493		..... Lillie Irene (Frances Elizabeth Kennedy's niece).
482		..... Marcy (Frances Elizabeth Kennedy's niece).
498		..... Mariah (Frances Elizabeth Kennedy's sister).
500		..... Nanch Isabell (Frances Elizabeth Kennedy's sister).
516		..... Nancy (Frances Elizabeth Kennedy's aunt).
528		..... Rebecca (Frances Elizabeth Kennedy's aunt).
491		..... Sadie Bell (Frances Elizabeth Kennedy's niece).
525		..... Samuel (Frances Elizabeth Kennedy's uncle).
505		..... Samuel Rufus (Frances Elizabeth Kennedy's brother).
526		..... Sarah Jane (Frances Elizabeth Kennedy's aunt).
512		..... Sarah Jane (Frances Elizabeth Kennedy's sister).
486		..... Willber (Frances Elizabeth Kennedy's nephew).
544		..... William (Frances Elizabeth Kennedy's great-grandfather).
509		..... William Edson (Frances Elizabeth Kennedy's brother).
210		KURTH, Nancy Sue (James's great-great-great-grandson's wife).
481		LAMBS- COBB, Mary Adele (Mable Pierce's mother).
170	26	LAVELLE, Catherine Susan (James's great-great-great-grandson's wife).
16	7	LETT, Cory (James's five-times-great-grandson).
15	7	..... Sara (James's five-times-great-granddaughter).
63	7	..... Tim (James's four-times-great-granddaughter's husband).
14	7	..... Tim (James's five-times-great-grandson).
260	47	LOTT, Calvin (James's great-great-granddaughter's husband).
43	18	..... Calvin E Terett (James's four-times-great-grandson).
147	47	..... Calvin Jay (James's great-great-great-grandson).
38	17	..... Delera Kay (James's four-times-great-granddaughter).
47	19	..... Diana (James's four-times-great-granddaughter).
143	47	..... Jimmy Ray (James's great-great-great-grandson).
152	47	..... John (James's great-great-great-grandson).
46	19	..... John Frank (James's four-times-great-grandson).
39	17	..... Kathy Ann (James's four-times-great-granddaughter).
42	18	..... Lee Ann Marie (James's four-times-great-granddaughter).
40	17	..... MAnnett Marie (James's four-times-great-granddaughter).
149	47	..... Mable Bea (James's great-great-great-granddaughter).
48	19	..... Michele (James's four-times-great-granddaughter).
153	47	..... Randy Eugene (James's great-great-great-grandson).
145	47	..... Rosa Lee (James's great-great-great-granddaughter).
41	17	..... Roxy Ann (James's four-times-great-granddaughter).
293		LUCAS, Thomas Dean (James's great-great-granddaughter's husband).
476		MADDEN, Lorraine (Bruce Douglas Whitman's wife).
177		..... Lorraine (James's great-great-great-grandson's wife).
319	66	MANNAHAN, Alice (James's great-grandson's wife).
265	50	MARIER, James Martin (James's great-great-granddaughter's husband).
163	50	..... Jane Marie (James's great-great-great-granddaughter).
160	50	..... Sherry Jean (James's great-great-great-granddaughter).



<u>Ref.</u>	<u>Tree</u>	<u>Name (Relationship)</u>
338	72	MARSHEL, Anna (James's grandson's wife).
502		MARTINDALE, Nancy Alice (Frances Elizabeth Kennedy's sister-in-law).
212		MASTERS, John Ellery (James's great-great-great-granddaughter's husband).
554		MATOXX, Sallie (Anne Elizabeth Van Orsdel's sister-in-law).
471		MC IWOAN, Mary (John David Kelley's great-great-grandmother).
451		MC RUTHER, Tonm (John David Kelley's uncle by marriage).
489		MCCLURE, Fay (Frances Elizabeth Kennedy's nephew's wife).
492		..... Jay (Frances Elizabeth Kennedy's niece's husband).
197		MCCREA, Edward J (James's great-great-great-granddaughter's husband).
13	6	MEYER, Cody (James's five-times-great-grandson).
12	6	..... Kayla (James's five-times-great-granddaughter).
60	6	..... Mark (James's four-times-great-granddaughter's husband).
457		MINTON, Carrie (John David Kelley's aunt).
452		..... Della (John David Kelley's aunt).
463		..... Ethel (John David Kelley's aunt).
454		..... Ida Catherine (John David Kelley's aunt).
453		..... Isabell May (John David Kelley's aunt).
455		..... James (John David Kelley's uncle).
466		..... James M (John David Kelley's grandfather).
456		..... Maggie (John David Kelley's aunt).
443		..... Mary Elizabeth (John David Kelley's mother).
460		..... Phillys (John David Kelley's aunt).
459		..... Rosayella (John David Kelley's aunt).
462		..... Walter (John David Kelley's uncle).
568		MITCHELL, Annie E (Anne Elizabeth Van Orsdel's sister-in-law).
373		MONTGOMERY, Cecil Ray (Betty Carol Fitzpatrick's mother's husband).
364		MULBERRY, Brenda Faye (Betty Carol Fitzpatrick's sister-in-law).
473		MULL, America (John David Kelley's great-great-grandmother).
413		MYERS, Mr. (John David Kelley's niece's husband).
214		NATION, Charles William, Jr. (James's great-great-great-granddaughter's husband).
288	57	NOLLER, Earlene Dee (James's great-great-grandson's wife).
376		OSBURN, Betty Jack (Betty Carol Fitzpatrick's grandmother).
106	37	PAGE, Donald Grant (James's four-times-great-grandson).
105	37	..... Johnathan Jack (James's four-times-great-grandson).
227	37	..... Ronald Otis (James's great-great-great-granddaughter's husband).
104	37	..... Thomas Elliott (James's four-times-great-grandson).
151		PATCHINS, Lawrence P (James's great-great-great-granddaughter's husband).
477		PEARCE, Alice (Mable Pierce's sister).
479		..... Thomas Earl (Mable Pierce's father).
175	29	PENDERGRASS, Cecelia Kay (James's great-great-grandson's wife).
494		PERRY, Elmer (Frances Elizabeth Kennedy's niece's husband).
309	63	PETERS, Fred (James's great-granddaughter's husband).
244	63	..... Grace (James's great-great-granddaughter).
245	63	..... John (James's great-great-grandson).
65		PHELPS, Mike (James's four-times-great-granddaughter's husband).
480		PHIPPS, James (Mable Pierce's mother's husband).
478		..... Virgie (Mable Pierce's half-sister).
317	65	PIERCE, Mable (James's great-grandson's wife).
560		POLLARD, John Benjamin (Anne Elizabeth Van Orsdel's brother-in-law).
235	41	PORTER, Kae (James's great-great-great-grandson's wife).
394		PRUITT, Allen Todd (John David Kelley's great-nephew).
392		..... Cristine Mae (John David Kelley's great-niece).
390		..... Danny James (John David Kelley's great-nephew).
415		..... Harold Lee (John David Kelley's niece's husband).
389		..... Harold Lee, Jr. (John David Kelley's great-nephew).
393		..... Michael Cameron (John David Kelley's great-nephew).
391		..... Ruth Ann (John David Kelley's great-nephew).
51	12	RAMSEY (ADOPTED), Michale (James's four-times-great-grandson).
134	45	RAMSEY, Afton Ernstine (Marier) (James's great-great-great-granddaughter).
132	45	..... Earl Efton (Butch) (James's great-great-great-grandson).
256	45	..... Earl N (James's great-great-granddaughter's husband).
55	12	..... Melinda (adopted) (James's four-times-great-granddaughter).

<u>Ref.</u>	<u>Tree</u>	<u>Name (Relationship)</u>
545		RAYNOR, Jake (Frances Elizabeth Kennedy's great-grandfather).
541		..... Sarah Jane (Frances Elizabeth Kennedy's grandmother).
253	44	REAM, Gladys Eleanor (James's great-great-grandson's wife).
220	59	REDMAN, Kathleen Marie (James's great-great-great-granddaughter).
224	59	..... Kathryn Victoria (James's great-great-great-granddaughter).
291	59	..... Ronald Clark (James's great-great-granddaughter's husband).
225	59	..... Ronnie Wesley (James's great-great-great-grandson).
171	27	REED, Danielle (James's great-great-great-grandson's wife).
521		RHINEHEART, Elizabeth (Frances Elizabeth Kennedy's aunt by marriage).
166		RHOADS, Rita Dianne (James's great-great-great-grandson's wife).
562		ROGERS, Thomas (Anne Elizabeth Van Orsdel's brother-in-law).
192	53	ROGERSON, Robert Harry (James's great-great-great-grandson).
278	53	..... Robert Orrin (James's great-great-granddaughter's husband).
194	53	..... Ruth Orrine (James's great-great-great-granddaughter).
193	53	..... Wilma Elaine (James's great-great-great-granddaughter).
575		RYNEARSON, Samuel (Anne Elizabeth Van Orsdel's uncle by marriage).
458		SADLER, Mr. (John David Kelley's uncle by marriage).
438		..... Raymond (John David Kelley's cousin).
593		SAPP, Archie (Cristine Sapp's brother).
595		..... Clara Belle (Cristine Sapp's sister).
433		..... Cristine (John David Kelley's sister-in-law).
591		..... Everett (Cristine Sapp's brother).
596		..... John Harvey (Cristine Sapp's father).
592		..... Lizzie (Cristine Sapp's sister).
594		..... Roy (Cristine Sapp's brother).
280		SCHILLING, Vyril M (James's great-great-granddaughter's husband).
243	62	SCHMELING, Amy Nichole (James's great-great-great-granddaughter).
300	62	..... Craig Martin (James's great-great-granddaughter's husband).
242	62	..... Tyler Martin (James's great-great-great-grandson).
161		SCHOENWALD, Jim (James's great-great-great-granddaughter's husband).
581		SCOMP, Annie E (Anne Elizabeth Van Orsdel's aunt).
578		..... George (Anne Elizabeth Van Orsdel's uncle).
583		..... Hanna (Anne Elizabeth Van Orsdel's aunt).
580		..... Henry (Anne Elizabeth Van Orsdel's uncle).
588		..... Jacob (Anne Elizabeth Van Orsdel's grandmother's husband).
579		..... John (Anne Elizabeth Van Orsdel's uncle).
582		..... Sally (Anne Elizabeth Van Orsdel's aunt).
384		SCOTT, Donna (John David Kelley's great-niece).
383		..... Gary (John David Kelley's great-nephew).
408		..... Pete (John David Kelley's niece's husband).
103	36	SELF, Ashley Chester (James's four-times-great-grandson).
102	36	..... Ian Mathew (James's four-times-great-grandson).
189	36	..... Stanley Howard (James's great-great-great-granddaughter's husband).
101	36	..... Stuart Branson (James's four-times-great-grandson).
549		SELLERS, Elizabeth (Frances Elizabeth Kennedy's great-grandmother).
363		SHAW, Linda D (Betty Carol Fitzpatrick's sister-in-law).
517		SHEPHERD, Benjamin Kirk (Frances Elizabeth Kennedy's uncle by marriage).
499		SHIDLER, Alferd (Frances Elizabeth Kennedy's brother-in-law).
223		SHOEMAKER, Jamie Paul (James's great-great-great-granddaughter's husband).
380		SIZMOORE, Cynthia (Betty Carol Fitzpatrick's great-grandmother).
589		SKELTON, James Franklin (Mary Elizabeth Skelton's father).
511		..... Mary Elizabeth (Frances Elizabeth Kennedy's sister-in-law).
50	20	SLOANE, Larry (James's four-times-great-grandson).
49	20	..... Lisa (James's four-times-great-granddaughter).
150	20	..... Mr. (James's great-great-great-granddaughter's husband).
469		SMITH, Elizabeth (John David Kelley's great-grandmother).
187	35	..... Fred Winton (James's great-great-great-granddaughter's husband).
99	35	..... Fred Winton (James's four-times-great-grandson).
168	25	..... Paula Jo (James's great-great-great-grandson's wife).
587		SMOCK, Mary Vicker (Anne Elizabeth Van Orsdel's grandmother).
20	9	SOBO, Brenda Sue (James's four-times-great-granddaughter).
127	9	..... Cornell Alexander, Jr. (James's great-great-great-granddaughter's husband).

<u>Ref.</u>	<u>Tree</u>	<u>Name (Relationship)</u>
4	2	SOBO, Julie Erin (James's five-times-great-granddaughter).
3	2	..... Justin Kyle (James's five-times-great-grandson).
22	9	..... Randy Eugene (James's four-times-great-grandson).
24	9	..... Teresa Lynn (James's four-times-great-granddaughter).
5	2	..... Travis Andrew (James's five-times-great-grandson).
6	2	..... Tyler Jamison (James's five-times-great-grandson).
64		STAMPS, George (James's four-times-great-granddaughter's husband).
250	64	STEWART, Charles Leroy (James's great-great-grandson).
311	64	..... Ed (James's great-granddaughter's husband).
247	64	..... Frances Luella (James's great-great-granddaughter).
248	64	..... George Martin (James's great-great-grandson).
246	64	..... Mable Vilote (James's great-great-granddaughter).
249	64	..... Olive Ruth (James's great-great-granddaughter).
258	46	STOCKWELL, Ellen (Dude) (James's great-great-granddaughter's husband).
148	19	STURGESS, Jo Ann (James's great-great-great-grandson's wife).
382		THOMAS, Lana (Betty Carol Fitzpatrick's great-grandmother).
140	15	THOMPSON, Alice (James's great-great-great-grandson's wife).
98	34	..... Bradly Tommy (James's four-times-great-grandson).
179	31	..... Carolyn M (James's great-great-great-grandson's wife).
371		..... Charles Raymond (Betty Carol Fitzpatrick's brother-in-law).
360		..... Charles Raymond, Jr. (Betty Carol Fitzpatrick's nephew).
361		..... Donna Denice (Betty Carol Fitzpatrick's niece).
185	34	..... Tommy M (James's great-great-great-granddaughter's husband).
556		THORNHELL, Reubin (Anne Elizabeth Van Orsdel's brother-in-law).
215		TOMAYER, Gerald Noller (James's great-great-great-granddaughter's husband).
419		TREADWAY, Mr. (John David Kelley's niece's husband).
506		TREDWAY, Lillie (Frances Elizabeth Kennedy's sister-in-law).
496		UNKNOWN, Alice (Frances Elizabeth Kennedy's nephew's wife).
68		..... Barbara (James's four-times-great-grandson's wife).
441		..... Bill Tom (John David Kelley's cousin).
401		..... Billy Joe (John David Kelley's great-nephew).
400		..... Bonnie Sue (John David Kelley's great-niece).
359		..... Brian (Betty Carol Fitzpatrick's niece's husband).
386		..... Charles (John David Kelley's great-nephew).
403		..... Chip (John David Kelley's great-nephew).
387		..... Clarence (John David Kelley's great-nephew).
388		..... Elizabeth Faye (John David Kelley's great-niece).
585		..... Ellen (Anne Elizabeth Van Orsdel's grandmother).
440		..... Eugene (John David Kelley's cousin).
439		..... James (John David Kelley's cousin).
350		..... Jaydon (Betty Carol Fitzpatrick's great-nephew).
402		..... Jimmy (John David Kelley's great-nephew).
365		..... Karen (Betty Carol Fitzpatrick's sister-in-law).
404		..... Kim (John David Kelley's great-niece).
251		..... Lucy (James's great-great-grandson's wife).
590		..... Mary Jane (Mary Elizabeth Skelton's mother).
597		..... Mary Miranda (Cristine Sapp's mother).
461		..... Mr. (John David Kelley's uncle by marriage).
426		..... Ms. (John David Kelley's nephew's wife).
410		..... Opal (John David Kelley's nephew's wife).
543		..... Ruth (Frances Elizabeth Kennedy's grandmother).
564		VAN ORSDEL, Abram (Anne Elizabeth Van Orsdel's brother).
570		..... Abram F, Jr. (Anne Elizabeth Van Orsdel's father).
584		..... Abram Van Orsdel (Anne Elizabeth Van Orsdel's grandfather).
341	73	..... Anne Elizabeth (James's daughter-in-law).
567		..... Henery George (Anne Elizabeth Van Orsdel's brother).
565		..... Isabell (Anne Elizabeth Van Orsdel's sister).
553		..... James H (Anne Elizabeth Van Orsdel's brother).
555		..... Mary B (Anne Elizabeth Van Orsdel's sister).
559		..... Melinda Catherine (Anne Elizabeth Van Orsdel's sister).
557		..... Rebecca Ellen (Anne Elizabeth Van Orsdel's sister).
561		..... Sarah E (Anne Elizabeth Van Orsdel's sister).

<u>Ref.</u>	<u>Tree</u>	<u>Name (Relationship)</u>
551		VAN ORSDEL, William George (Anne Elizabeth Van Orsdel's brother).
577		VAN ORSEDEL, Jane (Anne Elizabeth Van Orsdel's aunt by marriage).
566		WALLACE, James H (Anne Elizabeth Van Orsdel's brother-in-law).
412		WALTON, Mr. (John David Kelley's niece's husband).
315		WEIBEL, Ester (James's great-grandson's wife).
219		WELLS, Richard Lee (James's great-great-great-granddaughter's husband).
57		WERT, Gregory (James's four-times-great-granddaughter's husband).
29		WHITE, David Lester (James's four-times-great-granddaughter's husband).
508		WHITED, Louise (Frances Elizabeth Kennedy's sister-in-law).
178	52	WHITMAN, Boyd David (James's great-great-great-grandson).
276	52	..... Bruce Douglas (James's great-great-great-granddaughter's husband).
191	52	..... Charles (James's great-great-great-grandson).
182	52	..... Charlotte Louize (James's great-great-great-granddaughter).
100	35	..... Collin Wade (James's four-times-great-grandson).
94	32	..... Gail Robin (James's four-times-great-granddaughter).
93	32	..... Grant Douglas (James's four-times-great-grandson).
188	52	..... Laurel Alice (James's great-great-great-granddaughter).
184	52	..... Marcella Ann (James's great-great-great-granddaughter).
474		..... Marcus Pine (Bruce Douglas Whitman's son).
89	30	..... Marcus Pine (James's four-times-great-grandson).
90	31	..... Micheal Gerald Sturm (James's four-times-great-grandson).
92	31	..... Nathanielle Rebecca (James's four-times-great-granddaughter).
174	52	..... Nelson Chester (James's great-great-great-grandson).
91	31	..... Patrick Keith (James's four-times-great-grandson).
88	29	..... Peri Ann (James's four-times-great-granddaughter).
186	52	..... Phillis Lana (James's great-great-great-granddaughter).
180	52	..... Richard Ward (James's great-great-great-grandson).
87	29	..... Robbyn Cherter (James's four-times-great-grandson).
355		WILLIAMS, Candice Machael (Betty Carol Fitzpatrick's niece).
142	16	..... Carolyn (James's great-great-great-grandson's wife).
550		..... John (Anne Elizabeth Van Orsdel's husband).
368		..... Robert Therman (Betty Carol Fitzpatrick's brother-in-law).
297	61	WILSON, Albert Norman (James's great-great-granddaughter's husband).
239	61	..... Kenneth Logan (James's great-great-great-grandson).
240	61	..... Phyllis Ann (James's great-great-great-granddaughter).
238	61	..... Richard Norman (James's great-great-great-grandson).
513		WIRTZ, Jesse (Frances Elizabeth Kennedy's sister).
573		WOOD, Gideon (Anne Elizabeth Van Orsdel's uncle by marriage).
31		WURTZ, Dairld Gean (James's four-times-great-granddaughter's husband).
173	28	YOUNG, Brigid Ann (James's great-great-great-grandson's wife).