

A Complete Genealogy Report For

WILLIAM KENNEDY

Created on 8 February 2009
"The Complete Genealogy Reporter"
© 2006-2007 Nigel Bufton
under license to MyHeritage Family Tree Builder



CONTENTS

1. PATERNAL ANCESTRY.
2. MATERNAL ANCESTRY.
3. DESCENDANTS.
4. DIRECT RELATIONS.
5. INDIRECTLY RELATED via BETTY CAROL FITZPATRICK.
6. INDIRECTLY RELATED via JOHN DAVID KELLEY.
7. INDIRECTLY RELATED via BRUCE DOUGLAS WHITMAN.
8. INDIRECTLY RELATED via MABLE PIERCE.
9. INDIRECTLY RELATED via CHARLES ALONZO KENNADAY.
10. INDIRECTLY RELATED via MARY ELIZABETH SKELTON.
11. INDIRECTLY RELATED via SARAH ANN ANKROM.
12. INDIRECTLY RELATED via SARAH JANE RAYNOR.
13. INDIRECTLY RELATED via CRISTINE SAPP.
14. INDIRECTLY RELATED via BETTY EARLYWINE.
15. FAMILY TREES.
16. INDEX OF PLACES.
17. INDEX OF DATES.
18. INDEX OF INDIVIDUALS.

1. PATERNAL ANCESTRY

2. MATERNAL ANCESTRY

3. DESCENDANTS

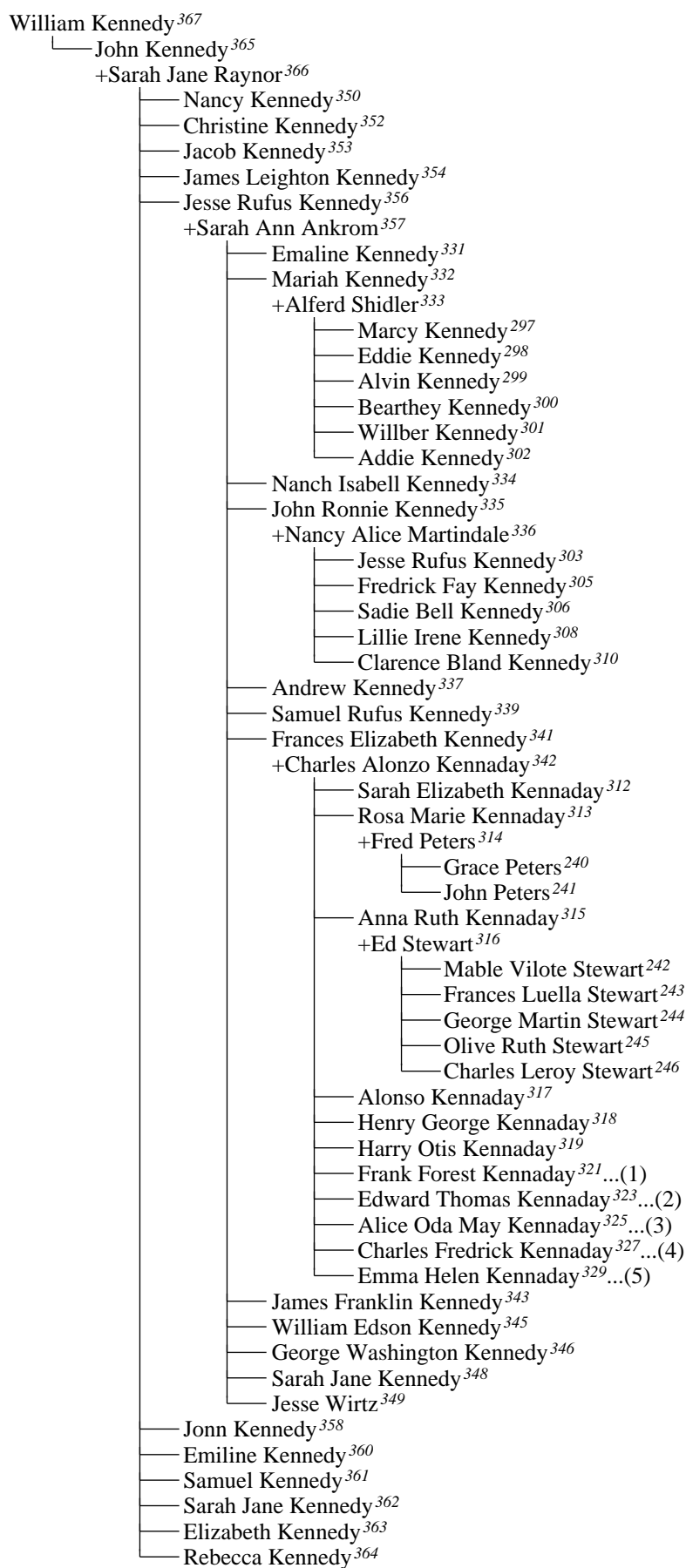

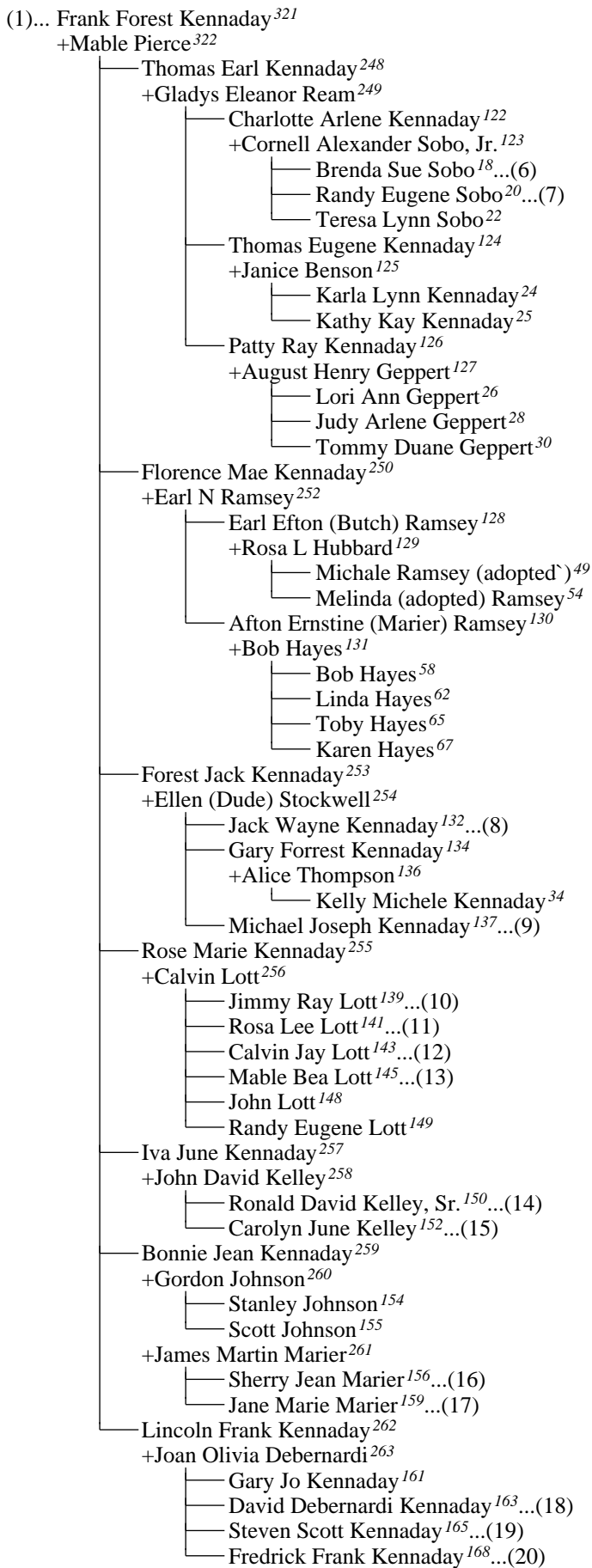

- (2)... Edward Thomas Kennaday³²³
+Alice Mannahan³²⁴
|— William C Kennaday²⁶⁴
|— John E Kennaday²⁶⁵
|— Mary Lou Kennaday²⁶⁶
|— Catherine Marie Kennaday²⁶⁷
|— Fred E Kennaday²⁶⁸
|— James Kennaday²⁶⁹
|— Alice Ann Kennaday²⁷⁰

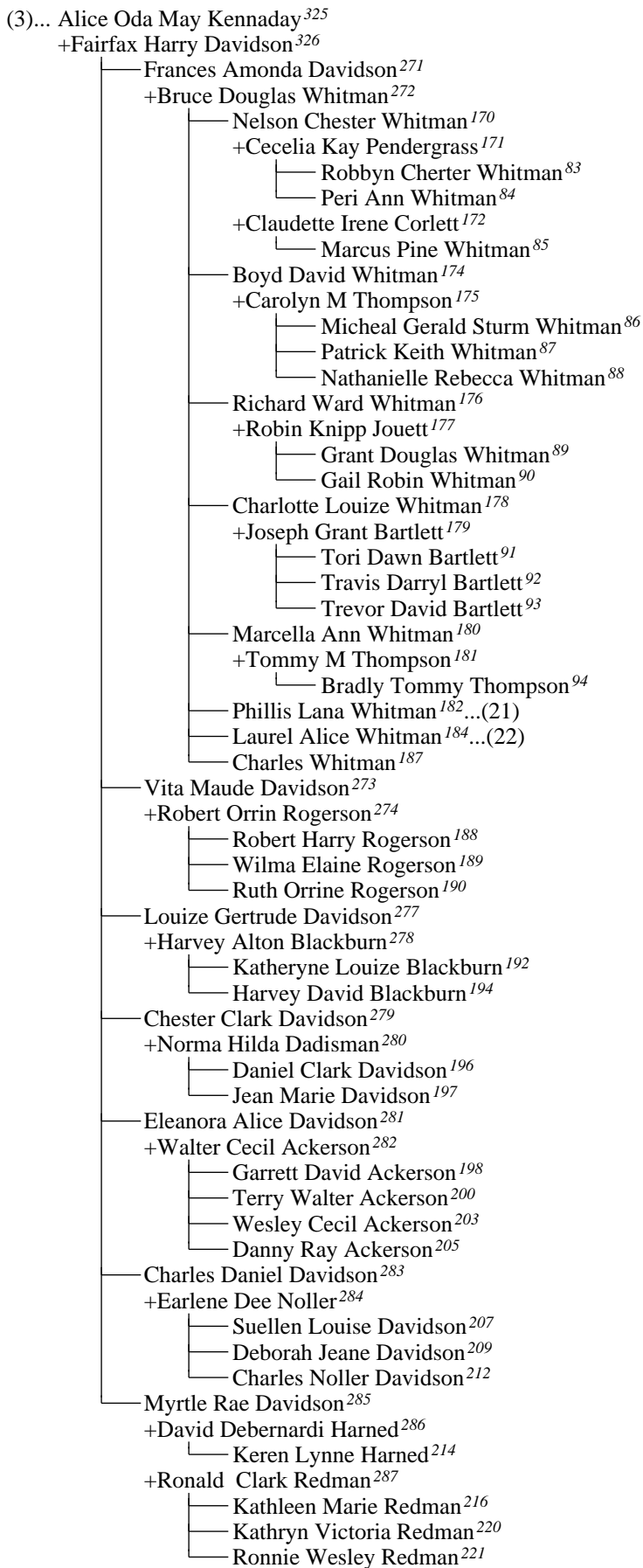

(4)... Charles Fredrick Kennaday³²⁷
 +Margaret Bays³²⁸
 └── Frances Ann Kennaday²⁸⁸

(5)... Emma Helen Kennaday³²⁹
 +Logan Turner Cairns³³⁰

- └── Jack Lavoy Cairns²⁹⁰
 - +Beverly Ann Johnson²⁹¹
 - └── Linda Ann Cairns²²²
 - +Ronald Otis Page²²³
 - └── Thomas Elliott Page¹⁰⁰
 - └── Johnathan Jack Page¹⁰¹
 - └── Donald Grant Page¹⁰²
 - └── Christine Marie Cairns²²⁴
 - +Craig Campbell²²⁵
 - └── Triana Marie Campbell¹⁰³
 - └── Holly Ann Campbell¹⁰⁴
 - └── Eric Raymond Campbell¹⁰⁵
 - └── Jack Lavoy Cairns, Jr.²²⁶
 - +Rebecca Cassler²²⁷
 - └── Rachel Elizabeth Cairns¹⁰⁶
 - └── Mary Melissa Cairns¹⁰⁷
 - └── Elizabeth Kay Cairns²²⁸
 - +Alan Hansen²²⁹
 - └── Jeremy Alan Hansen¹⁰⁸
 - └── Aaron Wayne Hansen¹⁰⁹
 - └── Michael Brent Hansen¹¹⁰
 - └── Amy Nicole Hansen¹¹¹
 - └── Jacob Karl Hansen¹¹²
 - └── William Wayne Cairns²³⁰
 - +Kae Porter²³¹
 - └── Dorci Kae Cairns¹¹³
 - └── Jace William Cairns¹¹⁴
 - └── Brindi Michelle Cairns¹¹⁵
 - └── Rebecca Gay Cairns²³²
 - +John Ellery Cooper²³³
 - └── Tiffany Anne Cooper¹¹⁶
 - └── Hillary Rane Cooper¹¹⁸
 - └── Margaret Faunita Cairns²⁹²
 - +Albert Norman Wilson²⁹³
 - └── Richard Norman Wilson²³⁴
 - └── Kenneth Logan Wilson²³⁵
 - └── Phyllis Ann Wilson²³⁶
 - +Carlie Jebens²³⁷
 - └── Kreetta Ann Jebens¹¹⁹
 - └── Korey Kay Jebens¹²⁰
 - └── Carlie Norman Jebens¹²¹
 - └── Dorothy Lorraine Cairns²⁹⁴
 - └── Judy Ann Cairns²⁹⁵
 - +Craig Martin Schmeling²⁹⁶
 - └── Tyler Martin Schmeling²³⁸
 - └── Amy Nichole Schmeling²³⁹

(6)... Brenda Sue Sobo¹⁸
 +James Vencent Boyd¹⁹
 └── Caitlin Arlena Boyd¹
 └── Jason Alexander Boyd²

- (7)... Randy Eugene Sobo²⁰
 +Kim Eileen Johnson²¹
 └— Justin Kyle Sobo³
 └— Julie Erin Sobo⁴
 └— Travis Andrew Sobo⁵
 └— Tyler Jamison Sobo⁶
- (8)... Jack Wayne Kennaday¹³²
 +Carol Lee Brant¹³³
 └— Todd Kennaday³¹
 └— +Joyce Ellen Jorgensen³²
 └— Adam Malaki Kennaday⁷
 └— Aaron Forest Kennaday⁸
 └— Darren Kennaday³³
- (9)... Michael Joseph Kennaday¹³⁷
 +Carolyn Williams¹³⁸
 └— Jeffrey Michael Kennaday³⁵
- (10)... Jimmy Ray Lott¹³⁹
 +Ellen Dollar Hyde¹⁴⁰
 └— Delera Kay Lott³⁶
 └— Kathy Ann Lott³⁷
 └— MAnnett Marie Lott³⁸
 └— Roxy Ann Lott³⁹
- (11)... Rosa Lee Lott¹⁴¹
 +Al Blunt¹⁴²
 └— Lee Ann Marie Lott⁴⁰
 └— Calvin E Terett Lott⁴¹
 └— Katy Sue Blunt⁴²
 └— Ed Blunt⁴³
- (12)... Calvin Jay Lott¹⁴³
 +Jo Ann Sturgess¹⁴⁴
 └— John Frank Lott⁴⁴
 └— Diana Lott⁴⁵
 └— Michele Lott⁴⁶
- (13)... Mable Bea Lott¹⁴⁵
 +Mr. Sloane¹⁴⁶
 └— Lisa Sloane⁴⁷
 └— Larry Sloane⁴⁸
- (14)... Ronald David Kelley, Sr.¹⁵⁰
 +Betty Carol Fitzpatrick¹⁵¹
 └— Lisa June Kelley⁵⁰
 └— +Cristian Hunnicutt⁵¹
 └— Christian David Hunnicutt⁹
 └— +James Mickel Asbury⁵²
 └— James Mathew Asbury¹⁰
 └— Liam Joseph Asbury¹¹
 └— Anna Carol Kelley⁵³
 └— Ronald David Kelley, Jr.⁵⁶

- (15)... Carolyn June Kelley¹⁵²
 +Norman Perry Curtis¹⁵³
- Anita Carol Curtis⁵⁷
 - +Tim Lett⁵⁹
 - Tim Lett¹²
 - Sara Lett¹³
 - Cory Lett¹⁴
 - Norman Perry Curtis, Jr.⁶³
 - Melony Jo Curtis⁶⁶
 - David Earl Curtis⁶⁸
 - +Toni Benner⁶⁹
 - Mercedes Curtis¹⁵
 - Savanna June Curtis¹⁶
 - Ivie Ski Curtis¹⁷
- (16)... Sherry Jean Marier¹⁵⁶
 +Gordon Johnson¹⁵⁸
- Gordon Scott (Scotty) Johnson⁷⁸
 - Stanley (Stan) Johnson⁷⁹
- (17)... Jane Marie Marier¹⁵⁹
 +Micheal A Forrester¹⁶⁰
- Mike Allen Forrester, Jr.⁸⁰
 - Tommy James Forrester⁸¹
 - Jamie Forrester⁸²
- (18)... David Debernardi Kennaday¹⁶³
 +Paula Jo Smith¹⁶⁴
- Nicholas Isaiah Kennaday⁷⁰
 - Elizabeth Alta Olivia Kennaday⁷¹
 - Cristina Dianne Kennaday⁷²
- (19)... Steven Scott Kennaday¹⁶⁵
 +Catherine Susan Lavelle¹⁶⁶
- Joshua Jolin Kennaday⁷³
- +Danielle Reed¹⁶⁷
- Mallory Kennaday⁷⁴
 - Reed Kennaday⁷⁵
- (20)... Fredrick Frank Kennaday¹⁶⁸
 +Brigid Ann Young¹⁶⁹
- Patricia Leigh Kennaday⁷⁶
 - Anthony Joseph Kennaday⁷⁷
- (21)... Phillis Lana Whitman¹⁸²
 +Fred Winton Smith¹⁸³
- Fred Winton Smith⁹⁵
 - Collin Wade Whitman⁹⁶
- (22)... Laurel Alice Whitman¹⁸⁴
 +Stanley Howard Self¹⁸⁵
- Stuart Branson Self⁹⁷
 - Ian Mathew Self⁹⁸
 - Ashley Chester Self⁹⁹

4. DIRECT RELATIONS

Generation of Six-Times-Great-Grandchildren

1. CAITLIN ARLENA BOYD (William's six-times-great-granddaughter) was born in 1992 in Manaqua, Nicaragua to James Vencent Boyd¹⁹ and Brenda Sue Sobo¹⁸, as shown in family tree 1.
2. JASON ALEXANDER BOYD (William's six-times-great-grandson) was born in 1994 to James Vencent Boyd¹⁹ and Brenda Sue Sobo¹⁸, as shown in family tree 1.
3. JUSTIN KYLE SOBO (William's six-times-great-grandson) was born in 1982 in Medford, Jackson, Organ, USA to Randy Eugene Sobo²⁰ and Kim Eileen Johnson²¹, as shown in family tree 2.
4. JULIE ERIN SOBO (William's six-times-great-granddaughter) was born in 1985 in Medford, Jackson, Organ, USA to Randy Eugene Sobo²⁰ and Kim Eileen Johnson²¹, as shown in family tree 2.
5. TRAVIS ANDREW SOBO (William's six-times-great-grandson) was born in 1987 in Medford, Jackson, Organ, USA to Randy Eugene Sobo²⁰ and Kim Eileen Johnson²¹, as shown in family tree 2.
6. TYLER JAMISON SOBO (William's six-times-great-grandson) was born in 1987 in Medford, Jackson, Organ, USA to Randy Eugene Sobo²⁰ and Kim Eileen Johnson²¹, as shown in family tree 2.
7. ADAM MALAKI KENNADAY (William's six-times-great-grandson) was born in 1987 in Anaheim, Orange, Calaforina, USA to Todd Kennaday³¹ and Joyce Ellen Jorgensen³², as shown in family tree 3.
8. AARON FOREST KENNADAY (William's six-times-great-grandson) was born in 1990 in Anaheim, Orange, Calaforina, USA to Todd Kennaday³¹ and Joyce Ellen Jorgensen³², as shown in family tree 3.
9. CHRISTIAN DAVID HUNNICUTT (William's six-times-great-grandson) was born on 10 January 1983 in Indianapolis, Indiana, USA to Cristian Hunnicutt⁵¹ and Lisa June Kelley⁵⁰, as shown in family tree 4.
10. JAMES MATHEW ASBURY (William's six-times-great-grandson) was born on 28 June 1991 in Lexington, Kentucky, USA to James Mickel Asbury⁵² and Lisa June Kelley⁵⁰, as shown in family tree 5.
11. LIAM JOSEPH ASBURY (William's six-times-great-grandson) was born to James Mickel Asbury⁵² and Lisa June Kelley⁵⁰, as shown in family tree 5.
12. TIM LETT (William's six-times-great-grandson) was born to Tim Lett⁵⁹ and Anita Carol Curtis⁵⁷, as shown in family tree 6.
13. SARA LETT (William's six-times-great-granddaughter) was born to Tim Lett⁵⁹ and Anita Carol Curtis⁵⁷, as shown in family tree 6.
14. CORY LETT (William's six-times-great-grandson) was born to Tim Lett⁵⁹ and Anita Carol Curtis⁵⁷, as shown in family tree 6.
15. MERCEDES CURTIS (William's six-times-great-granddaughter) was born in August 1994 in Indianapolis, Marion, Indiana, USA to David Earl Curtis⁶⁸ and Toni Benner⁶⁹, as shown in family tree 7.
16. SAVANNA JUNE CURTIS (William's six-times-great-granddaughter) was born on 14 June 1995 in Indianapolis, Marion, Indiana, USA to David Earl Curtis⁶⁸ and Toni Benner⁶⁹, as shown in family tree 7.
17. IVIE SKI CURTIS (William's six-times-great-granddaughter) was born on 11 November 1996 to David Earl Curtis⁶⁸ and Toni Benner⁶⁹, as shown in family tree 7.

Generation of Five-Times-Great-Grandchildren

18. BRENDA SUE SOBO (William's five-times-great-granddaughter) was born on 22 March 1958 in Klamath, Falls, Klamath, Organ, USA to Cornell Alexander Sobo, Jr.¹²³ and Charlotte Arlene Kennaday¹²², as shown in family tree 8.
19. JAMES VENCENT BOYD (William's five-times-great-granddaughter's husband) was born in 1956 in Cleveland, Ohio, USA.

James Vencent Boyd married Brenda Sue Sobo¹⁸. They had two children:

Caitlin Arlena Boyd¹ in 1992
 Jason Alexander Boyd² in 1994
This family is shown as family tree 1.

20. RANDY EUGENE SOBO (William's five-times-great-grandson) was born on 7 July 1959 in Medford, Jackson, Organ, USA to Cornell Alexander Sobo, Jr.¹²³ and Charlotte Arlene Kennaday¹²², as shown in family tree 8.
21. KIM EILEEN JOHNSON (William's five-times-great-grandson's wife).
 Randy Eugene Sobo²⁰ married Kim Eileen Johnson. They had four children:
 Justin Kyle Sobo³ in 1982
 Julie Erin Sobo⁴ in 1985
 Travis Andrew Sobo⁵ in 1987
 Tyler Jamison Sobo⁶ in 1987
This family is shown as family tree 2.
22. TERESA LYNN SOBO (William's five-times-great-granddaughter) was born on 19 August 1960 in Medford, Jackson, Organ, USA to Cornell Alexander Sobo, Jr.¹²³ and Charlotte Arlene Kennaday¹²², as shown in family tree 8.
23. TOM CLARIDGE (William's five-times-great-granddaughter's husband).
 Tom Claridge married Teresa Lynn Sobo²².
24. KARLA LYNN KENNADAY (William's five-times-great-granddaughter) was born on 8 July 1961 in Vallejo, Napa, Califorina, USA to Thomas Eugene Kennaday¹²⁴ and Janice Benson¹²⁵, as shown in family tree 9.
25. KATHY KAY KENNADAY (William's five-times-great-granddaughter) was born in 1962 in Vallejo, Napa, Califorina, USA to Thomas Eugene Kennaday¹²⁴ and Janice Benson¹²⁵, as shown in family tree 9.
26. LORI ANN GEPPERT (William's five-times-great-granddaughter) was born on 18 February 1960 in Portland, Washington, Organd, USA to August Henry Geppert¹²⁷ and Patty Ray Kennaday¹²⁶, as shown in family tree 10.
27. DAVID LESTER WHITE (William's five-times-great-granddaughter's husband).
 David Lester White married Lori Ann Geppert²⁶.
28. JUDY ARLENE GEPPERT (William's five-times-great-granddaughter) was born in 1962 in Portland, Washington, Organd, USA to August Henry Geppert¹²⁷ and Patty Ray Kennaday¹²⁶, as shown in family tree 10.
29. DAIRLD GEAN WURTZ (William's five-times-great-granddaughter's husband).
 Dairld Gean Wurtz married Judy Arlene Geppert²⁸.
30. TOMMY DUANE GEPPERT (William's five-times-great-grandson) was born in 1964 in Portland, Washington, Organd, USA to August Henry Geppert¹²⁷ and Patty Ray Kennaday¹²⁶, as shown in family tree 10.
31. TODD KENNADAY (William's five-times-great-grandson) was born on 5 May 1960 in Oregon to Jack Wayne Kennaday¹³² and Carol Lee Brant¹³³, as shown in family tree 13.
32. JOYCE ELLEN JORGENSEN (William's five-times-great-grandson's wife) was born in 1962 in Phoenix, Orange, Arizona, USA.
 Todd Kennaday³¹ married Joyce Ellen Jorgensen. They had two children:
 Adam Malaki Kennaday⁷ in 1987
 Aaron Forest Kennaday⁸ in 1990
This family is shown as family tree 3.
33. DARREN KENNADAY (William's five-times-great-grandson) was born on 19 February 1964 to Jack Wayne Kennaday¹³² and Carol Lee Brant¹³³, as shown in family tree 13.
34. KELLY MICHELE KENNADAY (William's five-times-great-granddaughter) was born on 9 July 1965 to Gary Forrest Kennaday¹³⁴ and Alice Thompson¹³⁶, as shown in family tree 14.
35. JEFFREY MICHAEL KENNADAY (William's five-times-great-grandson) was born on 26 September 1967 to Michael Joseph Kennaday¹³⁷ and Carolyn Williams¹³⁸, as shown in family tree 15.
36. DELERA KAY LOTT (William's five-times-great-granddaughter) was born on 8 November 1958 to Jimmy Ray Lott¹³⁹ and Ellen Dollar Hyde¹⁴⁰, as shown in family tree 16.
37. KATHY ANN LOTT (William's five-times-great-granddaughter) was born on 12 December 1960 to Jimmy Ray Lott¹³⁹ and Ellen Dollar Hyde¹⁴⁰, as shown in family tree 16.
38. MANNETT MARIE LOTT (William's five-times-great-granddaughter) was born on 4 June 1964 to Jimmy Ray Lott¹³⁹ and Ellen Dollar Hyde¹⁴⁰, as shown in family tree 16.

39. ROXY ANN LOTT (William's five-times-great-granddaughter) was born on 24 January 1966 to Jimmy Ray Lott¹³⁹ and Ellen Dollar Hyde¹⁴⁰, as shown in family tree 16.
40. LEE ANN MARIE LOTT (William's five-times-great-granddaughter) was born in August 1960 to Al Blunt¹⁴² and Rosa Lee Lott¹⁴¹, as shown in family tree 17.
41. CALVIN E TERETT LOTT (William's five-times-great-grandson) was born in July 1962 to Al Blunt¹⁴² and Rosa Lee Lott¹⁴¹, as shown in family tree 17.
42. KATY SUE BLUNT (William's five-times-great-granddaughter) was born on 21 June 1965 to Al Blunt¹⁴² and Rosa Lee Lott¹⁴¹, as shown in family tree 17.
43. ED BLUNT (William's five-times-great-grandson) was born to Al Blunt¹⁴² and Rosa Lee Lott¹⁴¹, as shown in family tree 17.
44. JOHN FRANK LOTT (William's five-times-great-grandson) was born on 23 September 1960 to Calvin Jay Lott¹⁴³ and Jo Ann Sturgess¹⁴⁴, as shown in family tree 18.
45. DIANA LOTT (William's five-times-great-granddaughter) was born on 13 September 1963 to Calvin Jay Lott¹⁴³ and Jo Ann Sturgess¹⁴⁴, as shown in family tree 18.
46. MICHELE LOTT (William's five-times-great-granddaughter) was born in June 1967 to Calvin Jay Lott¹⁴³ and Jo Ann Sturgess¹⁴⁴, as shown in family tree 18.
47. LISA SLOANE (William's five-times-great-granddaughter) was born to Mr. Sloane¹⁴⁶ and Mable Bea Lott¹⁴⁵, as shown in family tree 19.
48. LARRY SLOANE (William's five-times-great-grandson) was born to Mr. Sloane¹⁴⁶ and Mable Bea Lott¹⁴⁵, as shown in family tree 19.
49. MICHAEL RAMSEY (ADOPTED) (William's five-times-great-grandson) was born to Earl Efton (Butch) Ramsey¹²⁸ and Rosa L Hubbard¹²⁹, as shown in family tree 11.
50. LISA JUNE KELLEY (William's five-times-great-granddaughter) was born on 18 December 1963 in Carlisle, Kentucky, USA to Ronald David Kelley, Sr.¹⁵⁰ and Betty Carol Fitzpatrick¹⁵¹, as shown in family tree 20. (Lisa married twice. She was married to Cristian Hunnicutt⁵¹ and James Mickel Asbury⁵².)
51. CRISTIAN HUNNICUTT (William's five-times-great-granddaughter's husband) was born in Tennessee. Cristian Hunnicutt married Lisa June Kelley⁵⁰. They had one son:
Christian David Hunnicutt⁹ in 1983
This family is shown as family tree 4.
52. JAMES MICKEL ASBURY (William's five-times-great-granddaughter's husband) was born in Cynthiana, Kentucky, USA. James Mickel Asbury married Lisa June Kelley⁵⁰. They had two children:
James Mathew Asbury¹⁰ in 1991
Liam Joseph Asbury¹¹
This family is shown as family tree 5.
53. ANNA CAROL KELLEY (William's five-times-great-granddaughter) was born on 27 November 1964 to Ronald David Kelley, Sr.¹⁵⁰ and Betty Carol Fitzpatrick¹⁵¹, as shown in family tree 20.
54. MELINDA (ADOPTED) RAMSEY (William's five-times-great-granddaughter) was born to Earl Efton (Butch) Ramsey¹²⁸ and Rosa L Hubbard¹²⁹, as shown in family tree 11.
55. GREGORY WERT (William's five-times-great-granddaughter's husband). Gregory Wert married Anna Carol Kelley⁵³.
56. RONALD DAVID KELLEY, JR. (William's five-times-great-grandson) was born on 9 June 1966 in Lexington, Kentucky, USA to Ronald David Kelley, Sr.¹⁵⁰ and Betty Carol Fitzpatrick¹⁵¹, as shown in family tree 20. Ronald died on 15 September 1997, aged 31, in Indianapolis, Marion, Indiana, USA. He was buried in Washinton Park Cemetery, Indianapolis, Indiana.
57. ANITA CAROL CURTIS (William's five-times-great-granddaughter) was born on 9 April 1964 in ICarlisle, Nichlos, Kentucky, USA to Norman Perry Curtis¹⁵³ and Carolyn June Kelley¹⁵², as shown in family tree 21. (Anita married three times. She was married to Tim Lett⁵⁹, Mike Phelps⁶⁰ and George Stamps⁶¹.)

58. BOB HAYES (William's five-times-great-grandson) was born to Bob Hayes¹³¹ and Afton Ernstine (Marier) Ramsey¹³⁰, as shown in family tree 12.
59. TIM LETT (William's five-times-great-granddaughter's husband).
 Tim Lett married Anita Carol Curtis⁵⁷. They had three children:
 Tim Lett¹²
 Sara Lett¹³
 Cory Lett¹⁴
This family is shown as family tree 6.
60. MIKE PHELPS (William's five-times-great-granddaughter's husband).
 Mike Phelps married Anita Carol Curtis⁵⁷.
61. GEORGE STAMPS (William's five-times-great-granddaughter's husband).
 George Stamps married Anita Carol Curtis⁵⁷.
62. LINDA HAYES (William's five-times-great-granddaughter) was born in 1957 to Bob Hayes¹³¹ and Afton Ernstine (Marier) Ramsey¹³⁰, as shown in family tree 12.
63. NORMAN PERRY CURTIS, JR. (William's five-times-great-grandson) was born on 28 August 1966 in Indianapolis, Marion, Indiana, USA to Norman Perry Curtis¹⁵³ and Carolyn June Kelley¹⁵², as shown in family tree 21.
64. BARBARA UNKNOWN (William's five-times-great-grandson's wife).
 Norman Perry Curtis, Jr.⁶³ married Barbara Unknown.
65. TOBY HAYES (William's five-times-great-grandson) was born in 1958 to Bob Hayes¹³¹ and Afton Ernstine (Marier) Ramsey¹³⁰, as shown in family tree 12.
66. MELONY JO CURTIS (William's five-times-great-granddaughter) was born on 14 January 1970 in Indianapolis, Marion, Indiana, USA to Norman Perry Curtis¹⁵³ and Carolyn June Kelley¹⁵², as shown in family tree 21. Melony died on 8 December 1970 as an infant, in Indianapolis, Marion, Indiana, USA. She was buried in Carlisle, Cemetery, Carlisle, Kentucky.
67. KAREN HAYES (William's five-times-great-granddaughter) was born in 1962 to Bob Hayes¹³¹ and Afton Ernstine (Marier) Ramsey¹³⁰, as shown in family tree 12.
68. DAVID EARL CURTIS (William's five-times-great-grandson) was born on 17 April 1973 in Indianapolis, Marion, Indiana, USA to Norman Perry Curtis¹⁵³ and Carolyn June Kelley¹⁵², as shown in family tree 21.
69. TONI BENNER (William's five-times-great-grandson's wife).
 David Earl Curtis⁶⁸, aged 23, married Toni Benner on 7 July 1996. They had three children:
 Mercedes Curtis¹⁵ in 1994
 Savanna June Curtis¹⁶ in 1995
 Ivie Ski Curtis¹⁷ in 1996
This family is shown as family tree 7.
70. NICHOLAS ISAIAH KENNADAY (William's five-times-great-grandson) was born in 1978 in Roseburg, Douglas, Oregon, USA to David Debernardi Kennaday¹⁶³ and Paula Jo Smith¹⁶⁴, as shown in family tree 24.
71. ELIZABETH ALTA OLIVIA KENNADAY (William's five-times-great-granddaughter) was born in 1980 in Roseburg, Douglas, Oregon, USA to David Debernardi Kennaday¹⁶³ and Paula Jo Smith¹⁶⁴, as shown in family tree 24.
72. CRISTINA DIANNE KENNADAY (William's five-times-great-granddaughter) was born in 1982 in Roseburg, Douglas, Oregon, USA to David Debernardi Kennaday¹⁶³ and Paula Jo Smith¹⁶⁴, as shown in family tree 24.
73. JOSHUA JOLIN KENNADAY (William's five-times-great-grandson) was born in 1982 in Glide, Douglas, Oregon, USA to Steven Scott Kennaday¹⁶⁵ and Catherine Susan Lavelle¹⁶⁶, as shown in family tree 25.
74. MALLORY KENNADAY (William's five-times-great-granddaughter) was born to Steven Scott Kennaday¹⁶⁵ and Danielle Reed¹⁶⁷, as shown in family tree 26.
75. REED KENNADAY (William's five-times-great-grandson) was born to Steven Scott Kennaday¹⁶⁵ and Danielle Reed¹⁶⁷, as shown in family tree 26.

76. PATRICIA LEIGH KENNADAY (William's five-times-great-granddaughter) was born in 1979 in San Diego, San Diego, California, USA to Fredrick Frank Kennaday¹⁶⁸ and Brigid Ann Young¹⁶⁹, as shown in family tree 27.
77. ANTHONY JOSEPH KENNADAY (William's five-times-great-grandson) was born in 1981 in Roseburg, Douglas, Oregon, USA to Fredrick Frank Kennaday¹⁶⁸ and Brigid Ann Young¹⁶⁹, as shown in family tree 27.
78. GORDON SCOTT (SCOTTY) JOHNSON (William's five-times-great-grandson) was born on 10 August 1962 to Gordon Johnson¹⁵⁸ and Sherry Jean Marier¹⁵⁶, as shown in family tree 22.
79. STANLEY (STAN) JOHNSON (William's five-times-great-grandson) was born on 14 June 1965 to Gordon Johnson¹⁵⁸ and Sherry Jean Marier¹⁵⁶, as shown in family tree 22.
80. MIKE ALLEN FORRESTER, JR. (William's five-times-great-grandson) was born on 22 January 1966 to Micheal A Forrester¹⁶⁰ and Jane Marie Marier¹⁵⁹, as shown in family tree 23.
81. TOMMY JAMES FORRESTER (William's five-times-great-grandson) was born on 4 May 1968 to Micheal A Forrester¹⁶⁰ and Jane Marie Marier¹⁵⁹, as shown in family tree 23.
82. JAMIE FORRESTER (William's five-times-great-granddaughter) was born to Micheal A Forrester¹⁶⁰ and Jane Marie Marier¹⁵⁹, as shown in family tree 23.
83. ROBBYN CHERTER WHITMAN (William's five-times-great-grandson) was born in 1959 to Nelson Chester Whitman¹⁷⁰ and Cecelia Kay Pendergrass¹⁷¹, as shown in family tree 28.
84. PERI ANN WHITMAN (William's five-times-great-granddaughter) was born in 1960 to Nelson Chester Whitman¹⁷⁰ and Cecelia Kay Pendergrass¹⁷¹, as shown in family tree 28.
85. MARCUS PINE WHITMAN (William's five-times-great-grandson) was born in 1962 to Nelson Chester Whitman¹⁷⁰ and Claudette Irene Corlett¹⁷², as shown in family tree 29.
86. MICHEAL GERALD STURM WHITMAN (William's five-times-great-grandson) was born in 1968 to Boyd David Whitman¹⁷⁴ and Carolyn M Thompson¹⁷⁵, as shown in family tree 30.
87. PATRICK KEITH WHITMAN (William's five-times-great-grandson) was born in 1969 to Boyd David Whitman¹⁷⁴ and Carolyn M Thompson¹⁷⁵, as shown in family tree 30.
88. NATHANIELLE REBECCA WHITMAN (William's five-times-great-granddaughter) was born in 1973 to Boyd David Whitman¹⁷⁴ and Carolyn M Thompson¹⁷⁵, as shown in family tree 30.
89. GRANT DOUGLAS WHITMAN (William's five-times-great-grandson) was born in 1967 to Richard Ward Whitman¹⁷⁶ and Robin Knipp Jouett¹⁷⁷, as shown in family tree 31.
90. GAIL ROBIN WHITMAN (William's five-times-great-granddaughter) was born in 1968 to Richard Ward Whitman¹⁷⁶ and Robin Knipp Jouett¹⁷⁷, as shown in family tree 31.
91. TORI DAWN BARTLETT (William's five-times-great-granddaughter) was born in 1963 to Joseph Grant Bartlett¹⁷⁹ and Charlotte Louise Whitman¹⁷⁸, as shown in family tree 32.
92. TRAVIS DARRYL BARTLETT (William's five-times-great-grandson) was born in 1969 to Joseph Grant Bartlett¹⁷⁹ and Charlotte Louise Whitman¹⁷⁸, as shown in family tree 32.
93. TREVOR DAVID BARTLETT (William's five-times-great-grandson) was born in 1974 to Joseph Grant Bartlett¹⁷⁹ and Charlotte Louise Whitman¹⁷⁸, as shown in family tree 32.
94. BRADLY TOMMY THOMPSON (William's five-times-great-grandson) was born in 1966 to Tommy M Thompson¹⁸¹ and Marcella Ann Whitman¹⁸⁰, as shown in family tree 33.
95. FRED WINTON SMITH (William's five-times-great-grandson) was born in 1967 to Fred Winton Smith¹⁸³ and Phillis Lana Whitman¹⁸², as shown in family tree 34.
96. COLLIN WADE WHITMAN (William's five-times-great-grandson) was born in 1969 to Fred Winton Smith¹⁸³ and Phillis Lana Whitman¹⁸², as shown in family tree 34.

97. STUART BRANSON SELF (William's five-times-great-grandson) was born in 1974 to Stanley Howard Self¹⁸⁵ and Laurel Alice Whitman¹⁸⁴, as shown in family tree 35.
98. IAN MATHEW SELF (William's five-times-great-grandson) was born in 1975 to Stanley Howard Self¹⁸⁵ and Laurel Alice Whitman¹⁸⁴, as shown in family tree 35.
99. ASHLEY CHESTER SELF (William's five-times-great-grandson) was born in 1977 to Stanley Howard Self¹⁸⁵ and Laurel Alice Whitman¹⁸⁴, as shown in family tree 35.
100. THOMAS ELLIOTT PAGE (William's five-times-great-grandson) was born in 1971 in Ogden, Weber, Utah, USA to Ronald Otis Page²²³ and Linda Ann Cairns²²², as shown in family tree 36.
101. JOHNATHAN JACK PAGE (William's five-times-great-grandson) was born in 1973 in Rawlins, Carbon, Wyoming, USA to Ronald Otis Page²²³ and Linda Ann Cairns²²², as shown in family tree 36.
102. DONALD GRANT PAGE (William's five-times-great-grandson) was born in 1975 in Rawlins, Carbon, Wyoming, USA to Ronald Otis Page²²³ and Linda Ann Cairns²²², as shown in family tree 36.
103. TRIANA MARIE CAMPBELL (William's five-times-great-granddaughter) was born in 1978 in Salt Lake City, Salt Lake, Utah, USA to Craig Campbell²²⁵ and Christine Marie Cairns²²⁴, as shown in family tree 37.
104. HOLLY ANN CAMPBELL (William's five-times-great-granddaughter) was born in 1980 in Salt Lake City, Salt Lake, Utah, USA to Craig Campbell²²⁵ and Christine Marie Cairns²²⁴, as shown in family tree 37.
105. ERIC RAYMOND CAMPBELL (William's five-times-great-grandson) was born in 1985 in Salt Lake City, Salt Lake, Utah, USA to Craig Campbell²²⁵ and Christine Marie Cairns²²⁴, as shown in family tree 37.
106. RACHEL ELIZABETH CAIRNS (William's five-times-great-granddaughter) was born in 1979 to Jack Lavoy Cairns, Jr.²²⁶ and Rebecca Cassler²²⁷, as shown in family tree 38.
107. MARY MELISSA CAIRNS (William's five-times-great-granddaughter) was born in 1983 to Jack Lavoy Cairns, Jr.²²⁶ and Rebecca Cassler²²⁷, as shown in family tree 38.
108. JEREMY ALAN HANSEN (William's five-times-great-grandson) was born in 1975 in Craig, Moffat, Colorado, USA to Alan Hansen²²⁹ and Elizabeth Kay Cairns²²⁸, as shown in family tree 39.
109. AARON WAYNE HANSEN (William's five-times-great-grandson) was born in 1976 in Idaho Falls, Bonneville, Idaho, USA to Alan Hansen²²⁹ and Elizabeth Kay Cairns²²⁸, as shown in family tree 39.
110. MICHAEL BRENT HANSEN (William's five-times-great-grandson) was born in 1979 in Idaho Falls, Bonneville, Idaho, USA to Alan Hansen²²⁹ and Elizabeth Kay Cairns²²⁸, as shown in family tree 39.
111. AMY NICOLE HANSEN (William's five-times-great-granddaughter) was born in 1981 in Idaho Falls, Bonneville, Idaho, USA to Alan Hansen²²⁹ and Elizabeth Kay Cairns²²⁸, as shown in family tree 39.
112. JACOB KARL HANSEN (William's five-times-great-grandson) was born in 1983 in Idaho Falls, Bonneville, Idaho, USA to Alan Hansen²²⁹ and Elizabeth Kay Cairns²²⁸, as shown in family tree 39.
113. DORCI KAE CAIRNS (William's five-times-great-granddaughter) was born in 1983 in Idaho Falls, Bonneville, Idaho, USA to William Wayne Cairns²³⁰ and Kae Porter²³¹, as shown in family tree 40.
114. JACE WILLIAM CAIRNS (William's five-times-great-grandson) was born in 1988 in Idaho Falls, Bonneville, Idaho, USA to William Wayne Cairns²³⁰ and Kae Porter²³¹, as shown in family tree 40.
115. BRINDI MICHELLE CAIRNS (William's five-times-great-granddaughter) was born in 1991 in Idaho Falls, Bonneville, Idaho, USA to William Wayne Cairns²³⁰ and Kae Porter²³¹, as shown in family tree 40.
116. TIFFANY ANNE COOPER (William's five-times-great-granddaughter) was born in 1977 in Logan, Cache, Utah, USA to John Ellery Cooper²³³ and Rebecca Gay Cairns²³², as shown in family tree 41.
117. STEVE HIX (William's five-times-great-granddaughter's husband) was born in 1977.
Steve Hix married Tiffany Anne Cooper¹¹⁶.
118. HILLARY RANEE COOPER (William's five-times-great-granddaughter) was born in 1978 in Logan, Cache, Utah, USA to John Ellery Cooper²³³ and Rebecca Gay Cairns²³², as shown in family tree 41.

119. KREETA ANN JEBENS (William's five-times-great-granddaughter) was born in 1975 in Rawlins, Carbon, Wyoming, USA to Carlie Jebens²³⁷ and Phyllis Ann Wilson²³⁶, as shown in family tree 42.
120. KOREY KAY JEBENS (William's five-times-great-granddaughter) was born in 1977 in Rawlins, Carbon, Wyoming, USA to Carlie Jebens²³⁷ and Phyllis Ann Wilson²³⁶, as shown in family tree 42.
121. CARLIE NORMAN JEBENS (William's five-times-great-grandson) was born in 1979 in Rawlins, Carbon, Wyoming, USA to Carlie Jebens²³⁷ and Phyllis Ann Wilson²³⁶, as shown in family tree 42. Carlie died in 1995, aged about 16.

Generation of Four-Times-Great-Grandchildren

122. CHARLOTTE ARLENE KENNADAY (William's four-times-great-granddaughter) was born on 28 October 1933 to Thomas Earl Kennaday²⁴⁸ and Gladys Eleanor Ream²⁴⁹, as shown in family tree 43.
123. CORNELL ALEXANDER SOBO, JR. (William's four-times-great-granddaughter's husband) was born on 28 October 1933.
Cornell Alexander Sobo, Jr. married Charlotte Arlene Kennaday¹²². They had three children:
Brenda Sue Sobo¹⁸ in 1958
Randy Eugene Sobo²⁰ in 1959
Teresa Lynn Sobo²² in 1960
This family is shown as family tree 8.
124. THOMAS EUGENE KENNADAY (William's four-times-great-grandson) was born on 14 August 1935 in Saratoga, Carbon, Wyoming, USA to Thomas Earl Kennaday²⁴⁸ and Gladys Eleanor Ream²⁴⁹, as shown in family tree 43.
125. JANICE BENSON (William's four-times-great-grandson's wife).
Thomas Eugene Kennaday¹²⁴, aged about 24, married Janice Benson in 1960 in Antonio, Texas. They had two children:
Karla Lynn Kennaday²⁴ in 1961
Kathy Kay Kennaday²⁵ in 1962
This family is shown as family tree 9.
126. PATTY RAY KENNADAY (William's four-times-great-granddaughter) was born on 3 August 1937 in Rawlins, Carbon, Wyoming, USA to Thomas Earl Kennaday²⁴⁸ and Gladys Eleanor Ream²⁴⁹, as shown in family tree 43.
127. AUGUST HENRY GEPPERT (William's four-times-great-granddaughter's husband) was born in 1937 in Portland, Washington, Oregon, USA.
August Henry Geppert, aged about 21, married Patty Ray Kennaday¹²⁶, aged 20, on 26 July 1958. They had three children:
Lori Ann Geppert²⁶ in 1960
Judy Arlene Geppert²⁸ in 1962
Tommy Duane Geppert³⁰ in 1964
This family is shown as family tree 10.
128. EARL EFTON (BUTCH) RAMSEY (William's four-times-great-grandson) was born on 24 April 1937 to Earl N Ramsey²⁵² and Florence Mae Kennaday²⁵⁰, as shown in family tree 44.
129. ROSA L HUBBARD (William's four-times-great-grandson's wife) was born on 26 September 1937.
Earl Efton (Butch) Ramsey¹²⁸ married Rosa L Hubbard. They had two children:
Michale Ramsey (adopted)⁴⁹
Melinda (adopted) Ramsey⁵⁴
This family is shown as family tree 11.
130. AFTON ERNSTINE (MARIER) RAMSEY (William's four-times-great-granddaughter) was born to Earl N Ramsey²⁵² and Florence Mae Kennaday²⁵⁰, as shown in family tree 44.
131. BOB HAYES (William's four-times-great-granddaughter's husband).
Bob Hayes married Afton Ernstine (Marier) Ramsey¹³⁰. They had four children:
Bob Hayes⁵⁸
Linda Hayes⁶² in 1957
Toby Hayes⁶⁵ in 1958
Karen Hayes⁶⁷ in 1962
This family is shown as family tree 12.
132. JACK WAYNE KENNADAY (William's four-times-great-grandson) was born on 15 December 1939 to Ellen (Dude) Stockwell²⁵⁴ and Forest Jack Kennaday²⁵³, as shown in family tree 45.

133. CAROL LEE BRANT (William's four-times-great-grandson's wife).
 Jack Wayne Kennaday¹³² married Carol Lee Brant. They had two children:
 Todd Kennaday³¹ in 1960
 Darren Kennaday³³ in 1964
This family is shown as family tree 13.
134. GARY FORREST KENNADAY (William's four-times-great-grandson) was born on 7 February 1942 to Ellen (Dude) Stockwell²⁵⁴ and Forest Jack Kennaday²⁵³, as shown in family tree 45.
 (Gary married twice. He was married to Vicki Compton¹³⁵ and Alice Thompson¹³⁶.)
135. VICKI COMPTON (William's four-times-great-grandson's wife).
 Gary Forrest Kennaday¹³⁴ married Vicki Compton.
136. ALICE THOMPSON (William's four-times-great-grandson's wife).
 Gary Forrest Kennaday¹³⁴ married Alice Thompson. They had one daughter:
 Kelly Michele Kennaday³⁴ in 1965
This family is shown as family tree 14.
137. MICHAEL JOSEPH KENNADAY (William's four-times-great-grandson) was born to Ellen (Dude) Stockwell²⁵⁴ and Forest Jack Kennaday²⁵³, as shown in family tree 45.
138. CAROLYN WILLIAMS (William's four-times-great-grandson's wife).
 Michael Joseph Kennaday¹³⁷ married Carolyn Williams. They had one son:
 Jeffrey Michael Kennaday³⁵ in 1967
This family is shown as family tree 15.
139. JIMMY RAY LOTT (William's four-times-great-grandson) was born on 22 March 1940 to Calvin Lott²⁵⁶ and Rose Marie Kennaday²⁵⁵, as shown in family tree 46.
140. ELLEN DOLLAR HYDE (William's four-times-great-grandson's wife).
 Jimmy Ray Lott¹³⁹ married Ellen Dollar Hyde. They had four children:
 Delera Kay Lott³⁶ in 1958
 Kathy Ann Lott³⁷ in 1960
 MAnnett Marie Lott³⁸ in 1964
 Roxy Ann Lott³⁹ in 1966
This family is shown as family tree 16.
141. ROSA LEE LOTT (William's four-times-great-granddaughter) was born to Calvin Lott²⁵⁶ and Rose Marie Kennaday²⁵⁵, as shown in family tree 46.
142. AL BLUNT (William's four-times-great-granddaughter's husband).
 Al Blunt married Rosa Lee Lott¹⁴¹. They had four children:
 Lee Ann Marie Lott⁴⁰ in 1960
 Calvin E Terett Lott⁴¹ in 1962
 Katy Sue Blunt⁴² in 1965
 Ed Blunt⁴³
This family is shown as family tree 17.
143. CALVIN JAY LOTT (William's four-times-great-grandson) was born to Calvin Lott²⁵⁶ and Rose Marie Kennaday²⁵⁵, as shown in family tree 46.
144. JO ANN STURGESS (William's four-times-great-grandson's wife).
 Calvin Jay Lott¹⁴³ married Jo Ann Sturgess. They had three children:
 John Frank Lott⁴⁴ in 1960
 Diana Lott⁴⁵ in 1963
 Michele Lott⁴⁶ in 1967
This family is shown as family tree 18.
145. MABLE BEA LOTT (William's four-times-great-granddaughter) was born to Calvin Lott²⁵⁶ and Rose Marie Kennaday²⁵⁵, as shown in family tree 46.
 (Mable married twice. She was married to Mr. Sloane¹⁴⁶ and Lawrence P Patchins¹⁴⁷.)
146. MR. SLOANE (William's four-times-great-granddaughter's husband).
 Mr. Sloane married Mable Bea Lott¹⁴⁵. They had two children:
 Lisa Sloane⁴⁷
 Larry Sloane⁴⁸
This family is shown as family tree 19.
147. LAWERENCE P PATCHINS (William's four-times-great-granddaughter's husband).
 Lawrence P Patchins married Mable Bea Lott¹⁴⁵.

148. JOHN LOTT (William's four-times-great-grandson) was born to Calvin Lott²⁵⁶ and Rose Marie Kennaday²⁵⁵, as shown in family tree 46.
149. RANDY EUGENE LOTT (William's four-times-great-grandson) was born on 29 December 1962 to Calvin Lott²⁵⁶ and Rose Marie Kennaday²⁵⁵, as shown in family tree 46.
150. RONALD DAVID KELLEY, SR. (William's four-times-great-grandson) was born on 10 September 1943 in Pueblo, Colorado, USA to John David Kelley²⁵⁸ and Iva June Kennaday²⁵⁷, as shown in family tree 47.
151. BETTY CAROL FITZPATRICK (William's four-times-great-grandson's wife) was born on 14 April 1947 in Paris, Bourbon, Kentucky, USA to Pete Fitzpatrick Fitzpatrick³⁶⁸ and Virginia Ruth Gulett³⁶⁹.
[See also: Indirectly related via Betty Carol Fitzpatrick]
 Ronald David Kelley, Sr.¹⁵⁰, aged 19, married Betty Carol Fitzpatrick, aged 15, on 6 April 1963 in Carlisle, Kentucky, USA. They had three children:
 Lisa June Kelley⁵⁰ in 1963
 Anna Carol Kelley⁵³ in 1964
 Ronald David Kelley, Jr.⁵⁶ in 1966
This family is shown as family tree 20.
152. CAROLYN JUNE KELLEY (William's four-times-great-granddaughter) was born on 8 February 1945 in Carlisle, Kentucky, USA to John David Kelley²⁵⁸ and Iva June Kennaday²⁵⁷, as shown in family tree 47. Carolyn died on 23 August 1993, aged 48. She was buried in Cremation: Ashes on grave of Melony Jo Curtis Daughter.
153. NORMAN PERRY CURTIS (William's four-times-great-granddaughter's husband) was born in 1940. Norman Perry Curtis, aged about 22, married Carolyn June Kelley¹⁵², aged 17, on 12 January 1963 in Carlisle, Kentucky, USA. They had four children:
 Anita Carol Curtis⁵⁷ in 1964
 Norman Perry Curtis, Jr.⁶³ in 1966
 Melony Jo Curtis⁶⁶ in 1970
 David Earl Curtis⁶⁸ in 1973
This family is shown as family tree 21.
154. STANLEY JOHNSON (William's four-times-great-grandson) was born to Gordon Johnson²⁶⁰ and Bonnie Jean Kennaday²⁵⁹, as shown in family tree 48.
155. SCOTT JOHNSON (William's four-times-great-grandson) was born to Gordon Johnson²⁶⁰ and Bonnie Jean Kennaday²⁵⁹, as shown in family tree 48.
156. SHERRY JEAN MARIER (William's four-times-great-granddaughter) was born on 22 November 1942 to James Martin Marier²⁶¹ and Bonnie Jean Kennaday²⁵⁹, as shown in family tree 49.
 (Sherry married twice. She was married to Jim Schoenwald¹⁵⁷ and Gordon Johnson¹⁵⁸.)
157. JIM SCHOENWALD (William's four-times-great-granddaughter's husband).
 Jim Schoenwald married Sherry Jean Marier¹⁵⁶.
158. GORDON JOHNSON (William's four-times-great-granddaughter's husband).
 Gordon Johnson married Sherry Jean Marier¹⁵⁶. They had two children:
 Gordon Scott (Scotty) Johnson⁷⁸ in 1962
 Stanley (Stan) Johnson⁷⁹ in 1965
This family is shown as family tree 22.
159. JANE MARIE MARIER (William's four-times-great-granddaughter) was born on 4 February 1945 to James Martin Marier²⁶¹ and Bonnie Jean Kennaday²⁵⁹, as shown in family tree 49.
160. MICHEAL A FORRESTER (William's four-times-great-granddaughter's husband).
 Micheal A Forrester married Jane Marie Marier¹⁵⁹. They had three children:
 Mike Allen Forrester, Jr.⁸⁰ in 1966
 Tommy James Forrester⁸¹ in 1968
 Jamie Forrester⁸²
This family is shown as family tree 23.
161. GARY JO KENNADAY (William's four-times-great-grandson) was born on 4 March 1946 in Roseburg, Douglas, Oregon, USA to Lincoln Frank Kennaday²⁶² and Joan Olivia Debernardi²⁶³, as shown in family tree 50.
162. RITA DIANNE RHOADS (William's four-times-great-grandson's wife) was born in 1951.
 Gary Jo Kennaday¹⁶¹ married Rita Dianne Rhoads.
163. DAVID DEBERNARDI KENNADAY (William's four-times-great-grandson) was born on 8 January 1949 in Roseburg, Douglas, Oregon, USA to Lincoln Frank Kennaday²⁶² and Joan Olivia Debernardi²⁶³, as shown in family tree 50.

164. PAULA JO SMITH (William's four-times-great-grandson's wife) was born in 1953 in Roseburg, Douglas, Oregon, USA. David Debernardi Kennaday¹⁶³ married Paula Jo Smith. They had three children:
 Nicholas Isaiah Kennaday⁷⁰ in 1978
 Elizabeth Alta Olivia Kennaday⁷¹ in 1980
 Cristina Dianne Kennaday⁷² in 1982
This family is shown as family tree 24.
165. STEVEN SCOTT KENNADAY (William's four-times-great-grandson) was born on 5 March 1956 in Roseburg, Douglas, Oregon, USA to Lincoln Frank Kennaday²⁶² and Joan Olivia Debernardi²⁶³, as shown in family tree 50. (Steven married twice. He was married to Catherine Susan Lavelle¹⁶⁶ and Danielle Reed¹⁶⁷.)
166. CATHERINE SUSAN LAVELLE (William's four-times-great-grandson's wife) was born in 1956 in Van Nuys, California, USA. Steven Scott Kennaday¹⁶⁵ married Catherine Susan Lavelle. They had one son:
 Joshua Jolin Kennaday⁷³ in 1982
This family is shown as family tree 25.
167. DANIELLE REED (William's four-times-great-grandson's wife). Steven Scott Kennaday¹⁶⁵ married Danielle Reed. They had two children:
 Mallory Kennaday⁷⁴
 Reed Kennaday⁷⁵
This family is shown as family tree 26.
168. FREDRICK FRANK KENNADAY (William's four-times-great-grandson) was born on 5 May 1957 in Roseburg, Douglas, Oregon, USA to Lincoln Frank Kennaday²⁶² and Joan Olivia Debernardi²⁶³, as shown in family tree 50.
169. BRIGID ANN YOUNG (William's four-times-great-grandson's wife) was born in 1956 in Burbank, Los Angeles, California, USA. Fredrick Frank Kennaday¹⁶⁸ married Brigid Ann Young. They had two children:
 Patricia Leigh Kennaday⁷⁶ in 1979
 Anthony Joseph Kennaday⁷⁷ in 1981
This family is shown as family tree 27.
170. NELSON CHESTER WHITMAN (William's four-times-great-grandson) was born in 1939 in BigPiney, Sublette, Wyoming, USA to Bruce Douglas Whitman²⁷² and Frances Amonda Davidson²⁷¹, as shown in family tree 51. (Nelson married three times. He was married to Cecelia Kay Pendergrass¹⁷¹, Claudette Irene Corlett¹⁷² and Lorraine Madden¹⁷³.)
171. CECELIA KAY PENDERGRASS (William's four-times-great-grandson's wife). Nelson Chester Whitman¹⁷⁰ married Cecelia Kay Pendergrass. They had two children:
 Robbyn Cherter Whitman⁸³ in 1959
 Peri Ann Whitman⁸⁴ in 1960
This family is shown as family tree 28.
172. CLAUDETTE IRENE CORLETT (William's four-times-great-grandson's wife). Nelson Chester Whitman¹⁷⁰ married Claudette Irene Corlett. They had one son:
 Marcus Pine Whitman⁸⁵ in 1962
This family is shown as family tree 29.
173. LORRAINE MADDEN (William's four-times-great-grandson's wife) was born in 1962. Nelson Chester Whitman¹⁷⁰ married Lorraine Madden.
174. BOYD DAVID WHITMAN (William's four-times-great-grandson) was born in 1940 in BigPiney, Sublette, Wyoming, USA to Bruce Douglas Whitman²⁷² and Frances Amonda Davidson²⁷¹, as shown in family tree 51.
175. CAROLYN M THOMPSON (William's four-times-great-grandson's wife). Boyd David Whitman¹⁷⁴ married Carolyn M Thompson. They had three children:
 Micheal Gerald Sturm Whitman⁸⁶ in 1968
 Patrick Keith Whitman⁸⁷ in 1969
 Nathanielle Rebecca Whitman⁸⁸ in 1973
This family is shown as family tree 30.
176. RICHARD WARD WHITMAN (William's four-times-great-grandson) was born in 1941 in BigPiney, Sublette, Wyoming, USA to Bruce Douglas Whitman²⁷² and Frances Amonda Davidson²⁷¹, as shown in family tree 51.
177. ROBIN KNIPP JOUETT (William's four-times-great-grandson's wife). Richard Ward Whitman¹⁷⁶ married Robin Knipp Jouett. They had two children:
 Grant Douglas Whitman⁸⁹ in 1967
 Gail Robin Whitman⁹⁰ in 1968
This family is shown as family tree 31.

178. CHARLOTTE LOUIZE WHITMAN (William's four-times-great-granddaughter) was born in 1944 in BigPiney, Sublette, Wyoming, USA to Bruce Douglas Whitman²⁷² and Frances Amonda Davidson²⁷¹, as shown in family tree 51.
179. JOSEPH GRANT BARTLETT (William's four-times-great-granddaughter's husband).
Joseph Grant Bartlett married Charlotte Louize Whitman¹⁷⁸. They had three children:
Tori Dawn Bartlett⁹¹ in 1963
Travis Darryl Bartlett⁹² in 1969
Trevor David Bartlett⁹³ in 1974
This family is shown as family tree 32.
180. MARCELLA ANN WHITMAN (William's four-times-great-granddaughter) was born in 1946 to Bruce Douglas Whitman²⁷² and Frances Amonda Davidson²⁷¹, as shown in family tree 51.
181. TOMMY M THOMPSON (William's four-times-great-granddaughter's husband).
Tommy M Thompson married Marcella Ann Whitman¹⁸⁰. They had one son:
Bradly Tommy Thompson⁹⁴ in 1966
This family is shown as family tree 33.
182. PHILLIS LANA WHITMAN (William's four-times-great-granddaughter) was born in 1948 to Bruce Douglas Whitman²⁷² and Frances Amonda Davidson²⁷¹, as shown in family tree 51.
183. FRED WINTON SMITH (William's four-times-great-granddaughter's husband).
Fred Winton Smith married Phillis Lana Whitman¹⁸². They had two children:
Fred Winton Smith⁹⁵ in 1967
Collin Wade Whitman⁹⁶ in 1969
This family is shown as family tree 34.
184. LAUREL ALICE WHITMAN (William's four-times-great-granddaughter) was born in 1952 to Bruce Douglas Whitman²⁷² and Frances Amonda Davidson²⁷¹, as shown in family tree 51.
(Laurel married twice. She was married to Stanley Howard Self¹⁸⁵ and Everett Michael Corlett¹⁸⁶.)
185. STANLEY HOWARD SELF (William's four-times-great-granddaughter's husband).
Stanley Howard Self married Laurel Alice Whitman¹⁸⁴. They had three children:
Stuart Branson Self⁹⁷ in 1974
Ian Mathew Self⁹⁸ in 1975
Ashley Chester Self⁹⁹ in 1977
This family is shown as family tree 35.
186. EVERETT MICHAEL CORLETT (William's four-times-great-granddaughter's husband).
Everett Michael Corlett married Laurel Alice Whitman¹⁸⁴.
187. CHARLES WHITMAN (William's four-times-great-grandson) was born in 1957 to Bruce Douglas Whitman²⁷² and Frances Amonda Davidson²⁷¹, as shown in family tree 51.
188. ROBERT HARRY ROGERSON (William's four-times-great-grandson) was born in 1942 to Robert Orrin Rogerson²⁷⁴ and Vita Maude Davidson²⁷³, as shown in family tree 52. Robert died in 1953, aged about 11.
189. WILMA ELAINE ROGERSON (William's four-times-great-granddaughter) was born in 1948 to Robert Orrin Rogerson²⁷⁴ and Vita Maude Davidson²⁷³, as shown in family tree 52. Wilma died in 1965, aged about 17.
190. RUTH ORRINE ROGERSON (William's four-times-great-granddaughter) was born in 1949 to Robert Orrin Rogerson²⁷⁴ and Vita Maude Davidson²⁷³, as shown in family tree 52.
191. ROGER CAYLOR (William's four-times-great-granddaughter's husband).
Roger Caylor married Ruth Orrine Rogerson¹⁹⁰.
192. KATHERYNE LOUIZE BLACKBURN (William's four-times-great-granddaughter) was born in 1946 to Harvey Alton Blackburn²⁷⁸ and Louize Gertrude Davidson²⁷⁷, as shown in family tree 53.
193. EDWARD J MCCREA (William's four-times-great-granddaughter's husband) was born in 1945.
Edward J McCrea married Katheryne Louize Blackburn¹⁹².
194. HARVEY DAVID BLACKBURN (William's four-times-great-grandson) was born in 1953 to Harvey Alton Blackburn²⁷⁸ and Louize Gertrude Davidson²⁷⁷, as shown in family tree 53.
195. CELESTE MARIE HOFFMAN (William's four-times-great-grandson's wife) was born in 1963.
Harvey David Blackburn¹⁹⁴ married Celeste Marie Hoffman.
196. DANIEL CLARK DAVIDSON (William's four-times-great-grandson) was born in 1949 to Chester Clark Davidson²⁷⁹ and Norma Hilda Dadisman²⁸⁰, as shown in family tree 54.

197. JEAN MARIE DAVIDSON (William's four-times-great-granddaughter) was born in 1954 to Chester Clark Davidson²⁷⁹ and Norma Hilda Dadisman²⁸⁰, as shown in family tree 54.
198. GARRETT DAVID ACKERSON (William's four-times-great-grandson) was born in 1943 to Walter Cecil Ackerson²⁸² and Eleanora Alice Davidson²⁸¹, as shown in family tree 55.
199. EVELYN ANDERSON (William's four-times-great-grandson's wife) was born in 1948.
Garrett David Ackerson¹⁹⁸ married Evelyn Anderson.
200. TERRY WALTER ACKERSON (William's four-times-great-grandson) was born in 1945 to Walter Cecil Ackerson²⁸² and Eleanora Alice Davidson²⁸¹, as shown in family tree 55.
(Terry married twice. He was married to Kay Harding²⁰¹ and Patricia Cox²⁰².)
201. KAY HARDING (William's four-times-great-grandson's wife) was born in 1946.
Terry Walter Ackerson²⁰⁰ married Kay Harding.
202. PATRICIA COX (William's four-times-great-grandson's wife) was born in 1946.
Terry Walter Ackerson²⁰⁰ married Patricia Cox.
203. WESLEY CECIL ACKERSON (William's four-times-great-grandson) was born in 1947 to Walter Cecil Ackerson²⁸² and Eleanora Alice Davidson²⁸¹, as shown in family tree 55.
204. KRISTY LEE ARY (William's four-times-great-grandson's wife) was born in 1955.
Wesley Cecil Ackerson²⁰³ married Kristy Lee Ary.
205. DANNY RAY ACKERSON (William's four-times-great-grandson) was born in 1948 to Walter Cecil Ackerson²⁸² and Eleanora Alice Davidson²⁸¹, as shown in family tree 55.
206. NANCY SUE KURTH (William's four-times-great-grandson's wife) was born in 1950.
Danny Ray Ackerson²⁰⁵ married Nancy Sue Kurth.
207. SUELLEN LOUISE DAVIDSON (William's four-times-great-granddaughter) was born in 1951 to Charles Daniel Davidson²⁸³ and Earlene Dee Noller²⁸⁴, as shown in family tree 56.
208. JOHN ELLERY MASTERS (William's four-times-great-granddaughter's husband) was born in 1953.
John Ellery Masters married Suellen Louise Davidson²⁰⁷.
209. DEBORAH JEANE DAVIDSON (William's four-times-great-granddaughter) was born to Charles Daniel Davidson²⁸³ and Earlene Dee Noller²⁸⁴, as shown in family tree 56.
(Deborah married twice. She was married to Charles William Nation, Jr.²¹⁰ and Gerald Noller Tomayer²¹¹.)
210. CHARLES WILLIAM NATION, JR. (William's four-times-great-granddaughter's husband).
Charles William Nation, Jr. married Deborah Jeane Davidson²⁰⁹.
211. GERALD NOLLER TOMAYER (William's four-times-great-granddaughter's husband) was born in 1960.
Gerald Noller Tomayer married Deborah Jeane Davidson²⁰⁹.
212. CHARLES NOLLER DAVIDSON (William's four-times-great-grandson) was born in 1960 to Charles Daniel Davidson²⁸³ and Earlene Dee Noller²⁸⁴, as shown in family tree 56.
213. TONIA JENKINS (William's four-times-great-grandson's wife).
Charles Noller Davidson²¹² married Tonia Jenkins.
214. KEREN LYNNE HARNED (William's four-times-great-granddaughter) was born in 1963 to David Debernardi Harned²⁸⁶ and Myrtle Rae Davidson²⁸⁵, as shown in family tree 57.
215. RICHARD LEE WELLS (William's four-times-great-granddaughter's husband) was born in 1962.
Richard Lee Wells married Keren Lynne Harned²¹⁴.
216. KATHLEEN MARIE REDMAN (William's four-times-great-granddaughter) was born in 1965 to Ronald Clark Redman²⁸⁷ and Myrtle Rae Davidson²⁸⁵, as shown in family tree 58.
(Kathleen married three times. She was married to Timothy Tol Johnson²¹⁷, Richard Ferrin²¹⁸ and Jamie Paul Shoemaker²¹⁹.)
217. TIMOTHY TOL JOHNSON (William's four-times-great-granddaughter's husband).
Timothy Tol Johnson married Kathleen Marie Redman²¹⁶.
218. RICHARD FERRIN (William's four-times-great-granddaughter's husband).
Richard Ferrin married Kathleen Marie Redman²¹⁶.
219. JAMIE PAUL SHOEMAKER (William's four-times-great-granddaughter's husband).
Jamie Paul Shoemaker married Kathleen Marie Redman²¹⁶.
220. KATHRYN VICTORIA REDMAN (William's four-times-great-granddaughter) was born in 1970 to Ronald Clark Redman²⁸⁷ and Myrtle Rae Davidson²⁸⁵, as shown in family tree 58.

221. RONNIE WESLEY REDMAN (William's four-times-great-grandson) was born in 1974 to Ronald Clark Redman²⁸⁷ and Myrtle Rae Davidson²⁸⁵, as shown in family tree 58.
222. LINDA ANN CAIRNS (William's four-times-great-granddaughter) was born in 1950 to Jack Lavoy Cairns²⁹⁰ and Beverly Ann Johnson²⁹¹, as shown in family tree 59.
223. RONALD OTIS PAGE (William's four-times-great-granddaughter's husband) was born in 1950 in Colorado Springs, ElPaso, Colorado, USA.
 Ronald Otis Page married Linda Ann Cairns²²². They had three children:
 Thomas Elliott Page¹⁰⁰ in 1971
 Johnathan Jack Page¹⁰¹ in 1973
 Donald Grant Page¹⁰² in 1975
This family is shown as family tree 36.
224. CHRISTINE MARIE CAIRNS (William's four-times-great-granddaughter) was born in 1951 in Rawlins, Carbon, Wyoming, USA to Jack Lavoy Cairns²⁹⁰ and Beverly Ann Johnson²⁹¹, as shown in family tree 59.
225. CRAIG CAMPBELL (William's four-times-great-granddaughter's husband) was born in 1955.
 Craig Campbell married Christine Marie Cairns²²⁴. They had three children:
 Triana Marie Campbell¹⁰³ in 1978
 Holly Ann Campbell¹⁰⁴ in 1980
 Eric Raymond Campbell¹⁰⁵ in 1985
This family is shown as family tree 37.
226. JACK LAVOY CAIRNS, JR. (William's four-times-great-grandson) was born in 1953 in Rock Springs, Sweetwater, Wyoming, USA to Jack Lavoy Cairns²⁹⁰ and Beverly Ann Johnson²⁹¹, as shown in family tree 59.
227. REBECCA CASSLER (William's four-times-great-grandson's wife) was born in 1955.
 Jack Lavoy Cairns, Jr.²²⁶ married Rebecca Cassler. They had two children:
 Rachel Elizabeth Cairns¹⁰⁶ in 1979
 Mary Melissa Cairns¹⁰⁷ in 1983
This family is shown as family tree 38.
228. ELIZABETH KAY CAIRNS (William's four-times-great-granddaughter) was born in 1954 in Rawlins, Carbon, Wyoming, USA to Jack Lavoy Cairns²⁹⁰ and Beverly Ann Johnson²⁹¹, as shown in family tree 59.
229. ALAN HANSEN (William's four-times-great-granddaughter's husband).
 Alan Hansen married Elizabeth Kay Cairns²²⁸. They had five children:
 Jeremy Alan Hansen¹⁰⁸ in 1975
 Aaron Wayne Hansen¹⁰⁹ in 1976
 Michael Brent Hansen¹¹⁰ in 1979
 Amy Nicole Hansen¹¹¹ in 1981
 Jacob Karl Hansen¹¹² in 1983
This family is shown as family tree 39.
230. WILLIAM WAYNE CAIRNS (William's four-times-great-grandson) was born in 1955 in Rawlins, Carbon, Wyoming, USA to Jack Lavoy Cairns²⁹⁰ and Beverly Ann Johnson²⁹¹, as shown in family tree 59.
231. KAE PORTER (William's four-times-great-grandson's wife) was born in 1957 in Ceder City, Iron, Utah, USA.
 William Wayne Cairns²³⁰ married Kae Porter. They had three children:
 Dorci Kae Cairns¹¹³ in 1983
 Jace William Cairns¹¹⁴ in 1988
 Brindi Michelle Cairns¹¹⁵ in 1991
This family is shown as family tree 40.
232. REBECCA GAY CAIRNS (William's four-times-great-granddaughter) was born in 1956 in Rawlins, Carbon, Wyoming, USA to Jack Lavoy Cairns²⁹⁰ and Beverly Ann Johnson²⁹¹, as shown in family tree 59.
233. JOHN ELLERY COOPER (William's four-times-great-granddaughter's husband) was born in 1954 in Yonkers, New York, USA.
 John Ellery Cooper married Rebecca Gay Cairns²³². They had two children:
 Tiffany Anne Cooper¹¹⁶ in 1977
 Hillary Ranee Cooper¹¹⁸ in 1978
This family is shown as family tree 41.
234. RICHARD NORMAN WILSON (William's four-times-great-grandson) was born in 1953 in Rawlins, Carbon, Wyoming, USA to Albert Norman Wilson²⁹³ and Margaret Faunita Cairns²⁹², as shown in family tree 60.
235. KENNETH LOGAN WILSON (William's four-times-great-grandson) was born in 1954 in Rawlins, Carbon, Wyoming, USA to Albert Norman Wilson²⁹³ and Margaret Faunita Cairns²⁹², as shown in family tree 60.

236. PHYLLIS ANN WILSON (William's four-times-great-granddaughter) was born in 1955 in Rawlins, Carbon, Wyoming, USA to Albert Norman Wilson²⁹³ and Margaret Faunita Cairns²⁹², as shown in family tree 60.
237. CARLIE JEBENS (William's four-times-great-granddaughter's husband).
 Carlie Jebens married Phyllis Ann Wilson²³⁶. They had three children:
 Kreetta Ann Jebens¹¹⁹ in 1975
 Korey Kay Jebens¹²⁰ in 1977
 Carlie Norman Jebens¹²¹ in 1979
This family is shown as family tree 42.
238. TYLER MARTIN SCHMELING (William's four-times-great-grandson) was born in 1976 in Weatland, Platte, Wyoming, USA to Craig Martin Schmeling²⁹⁶ and Judy Ann Cairns²⁹⁵, as shown in family tree 61.
239. AMY NICHOLE SCHMELING (William's four-times-great-granddaughter) was born in 1978 in Cheyenne, Laramie, Wyoming, USA to Craig Martin Schmeling²⁹⁶ and Judy Ann Cairns²⁹⁵, as shown in family tree 61.

Generation of Great-Great-Great-Grandchildren

240. GRACE PETERS (William's great-great-great-granddaughter) was born to Fred Peters³¹⁴ and Rosa Marie Kennaday³¹³, as shown in family tree 62.
241. JOHN PETERS (William's great-great-great-grandson) was born to Fred Peters³¹⁴ and Rosa Marie Kennaday³¹³, as shown in family tree 62.
242. MABLE VILOTE STEWART (William's great-great-great-granddaughter) was born in 1906 to Ed Stewart³¹⁶ and Anna Ruth Kennaday³¹⁵, as shown in family tree 63.
243. FRANCES LUELLEA STEWART (William's great-great-great-granddaughter) was born in 1909 to Ed Stewart³¹⁶ and Anna Ruth Kennaday³¹⁵, as shown in family tree 63.
244. GEORGE MARTIN STEWART (William's great-great-great-grandson) was born in 1912 to Ed Stewart³¹⁶ and Anna Ruth Kennaday³¹⁵, as shown in family tree 63.
245. OLIVE RUTH STEWART (William's great-great-great-granddaughter) was born in 1921 in Blue Lake, Humboldt, Calaforina, USA to Ed Stewart³¹⁶ and Anna Ruth Kennaday³¹⁵, as shown in family tree 63.
246. CHARLES LEROY STEWART (William's great-great-great-grandson) was born in 1929 in Blue Lake, Humboldt, Calaforina, USA to Ed Stewart³¹⁶ and Anna Ruth Kennaday³¹⁵, as shown in family tree 63. Charles died in 1996, aged about 67.
247. LUCY UNKNOWN (William's great-great-great-grandson's wife).
 Charles Leroy Stewart²⁴⁶ married Lucy Unknown.
248. THOMAS EARL KENNADAY (William's great-great-great-grandson) was born on 7 July 1914 in Saratoga, Carbon, Wyoming, USA to Frank Forest Kennaday³²¹ and Mable Pierce³²², as shown in family tree 64.
249. GLADYS ELEANOR REAM (William's great-great-great-grandson's wife) was born in 1914 in Superior, Colorado, USA. Gladys died in 1990, aged about 76.
 Thomas Earl Kennaday²⁴⁸, aged 18, married Gladys Eleanor Ream, aged about 18, on 13 May 1933 in Rawlins, Carbon, Wyoming, USA. They had three children:
 Charlotte Arlene Kennaday¹²² in 1933
 Thomas Eugene Kennaday¹²⁴ in 1935
 Patty Ray Kennaday¹²⁶ in 1937
This family is shown as family tree 43.
250. FLORENCE MAE KENNADAY (William's great-great-great-granddaughter) was born on 28 June 1917 in Saratoga, Carbon, Wyoming, USA to Frank Forest Kennaday³²¹ and Mable Pierce³²², as shown in family tree 64. (Florence married twice. She was married to Mr. Bray²⁵¹ and Earl N Ramsey²⁵².)
251. MR. BRAY (William's great-great-great-granddaughter's husband).
 Mr. Bray married Florence Mae Kennaday²⁵⁰.
252. EARL N RAMSEY (William's great-great-great-granddaughter's husband) was born in 1911.
 Earl N Ramsey, aged about 24, married Florence Mae Kennaday²⁵⁰, aged 18, on 21 October 1935. They had two children:
 Earl Efton (Butch) Ramsey¹²⁸ in 1937
 Afton Ernstine (Marier) Ramsey¹³⁰
This family is shown as family tree 44.

253. FOREST JACK KENNADAY (William's great-great-great-grandson) was born on 22 November 1919 in Saratoga, Carbon, Wyoming, USA to Frank Forest Kennaday³²¹ and Mable Pierce³²², as shown in family tree 64.
254. ELLEN (DUDE) STOCKWELL (William's great-great-great-granddaughter's husband) was born in 1919 in Saratoga, Carbon, Wyoming, USA.
Ellen (Dude) Stockwell, aged about 25, married Forest Jack Kennaday²⁵³, aged 25, on 9 June 1945. They had three children:
Jack Wayne Kennaday¹³² in 1939
Gary Forrest Kennaday¹³⁴ in 1942
Michael Joseph Kennaday¹³⁷
This family is shown as family tree 45.
255. ROSE MARIE KENNADAY (William's great-great-great-granddaughter) was born on 10 October 1921 in Saratoga, Carbon, Wyoming, USA to Frank Forest Kennaday³²¹ and Mable Pierce³²², as shown in family tree 64.
256. CALVIN LOTT (William's great-great-great-granddaughter's husband).
Calvin Lott married Rose Marie Kennaday²⁵⁵. They had six children:
Jimmy Ray Lott¹³⁹ in 1940
Rosa Lee Lott¹⁴¹
Calvin Jay Lott¹⁴³
Mable Bea Lott¹⁴⁵
John Lott¹⁴⁸
Randy Eugene Lott¹⁴⁹ in 1962
This family is shown as family tree 46.
257. IVA JUNE KENNADAY (William's great-great-great-granddaughter) was born on 13 June 1923 in Saratoga, Carbon, Wyoming, USA to Frank Forest Kennaday³²¹ and Mable Pierce³²², as shown in family tree 64. Iva died on 16 March 2005, aged 81, in Indianapolis, Indiana, USA. She was buried in Carlisle Cemetary, Carlisle, Kentucky.
258. JOHN DAVID KELLEY (William's great-great-great-granddaughter's husband) was born on 29 December 1918 to Talmadge Blane Kelley⁴²⁹ and Mary Elizabeth Minton⁴³⁰. John died on 12 April 1970, aged 51, of Liver, in Carlisle, Kentucky, USA. He was buried in Carlisle Cemetary, Carlisle Kentucky.
[See also: Indirectly related via John David Kelley]
John David Kelley, aged 29, married Iva June Kennaday²⁵⁷, aged 25, on 8 August 1948 in Flemmingburg, Kentucky, USA. They had two children:
Ronald David Kelley, Sr.¹⁵⁰ in 1943
Carolyn June Kelley¹⁵² in 1945
This family is shown as family tree 47.
259. BONNIE JEAN KENNADAY (William's great-great-great-granddaughter) was born on 6 April 1925 to Frank Forest Kennaday³²¹ and Mable Pierce³²², as shown in family tree 64.
(Bonnie married twice. She was married to Gordon Johnson²⁶⁰ and James Martin Marier²⁶¹.)
260. GORDON JOHNSON (William's great-great-great-granddaughter's husband).
Gordon Johnson married Bonnie Jean Kennaday²⁵⁹. They had two children:
Stanley Johnson¹⁵⁴
Scott Johnson¹⁵⁵
This family is shown as family tree 48.
261. JAMES MARTIN MARIER (William's great-great-great-granddaughter's husband) was born on 22 February 1920 in El Vado, Rio Arriba, New Mexico, USA. James died in 1999, aged about 79.
James Martin Marier, aged 28, married Bonnie Jean Kennaday²⁵⁹, aged 23, on 6 April 1948. They had two children:
Sherry Jean Marier¹⁵⁶ in 1942
Jane Marie Marier¹⁵⁹ in 1945
This family is shown as family tree 49.
262. LINCOLN FRANK KENNADAY (William's great-great-great-grandson) was born on 9 April 1928 in Saratoga, Carbon, Wyoming, USA to Frank Forest Kennaday³²¹ and Mable Pierce³²², as shown in family tree 64.
263. JOAN OLIVIA DEBERNARDI (William's great-great-great-grandson's wife) was born on 30 April 1929 in Roseburg, Douglas, Oregon, USA.
Lincoln Frank Kennaday²⁶², aged 17, married Joan Olivia Debernardi, aged 16, on 25 October 1945. They had four children:
Gary Jo Kennaday¹⁶¹ in 1946
David Debernardi Kennaday¹⁶³ in 1949
Steven Scott Kennaday¹⁶⁵ in 1956
Fredrick Frank Kennaday¹⁶⁸ in 1957
This family is shown as family tree 50.

264. WILLIAM C KENNADAY (William's great-great-great-grandson) was born in 1920 in Saratoga, Carbon, Wyoming, USA to Edward Thomas Kennaday³²³ and Alice Mannahan³²⁴, as shown in family tree 65. William died in 1920 as an infant.
265. JOHN E KENNADAY (William's great-great-great-grandson) was born in 1927 in Saratoga, Carbon, Wyoming, USA to Edward Thomas Kennaday³²³ and Alice Mannahan³²⁴, as shown in family tree 65. John died in 1927 as an infant.
266. MARY LOU KENNADAY (William's great-great-great-granddaughter) was born in 1931 in Saratoga, Carbon, Wyoming, USA to Edward Thomas Kennaday³²³ and Alice Mannahan³²⁴, as shown in family tree 65. Mary died in 1972, aged about 41.
267. CATHERINE MARIE KENNADAY (William's great-great-great-granddaughter) was born in 1931 in Saratoga, Carbon, Wyoming, USA to Edward Thomas Kennaday³²³ and Alice Mannahan³²⁴, as shown in family tree 65. Catherine died in 1936, aged about 5.
268. FRED E KENNADAY (William's great-great-great-grandson) was born in 1932 in Saratoga, Carbon, Wyoming, USA to Edward Thomas Kennaday³²³ and Alice Mannahan³²⁴, as shown in family tree 65. Fred died in 1933, aged about 1.
269. JAMES KENNADAY (William's great-great-great-grandson) was born to Edward Thomas Kennaday³²³ and Alice Mannahan³²⁴, as shown in family tree 65.
270. ALICE ANN KENNADAY (William's great-great-great-granddaughter) was born in 1938 in Saratoga, Carbon, Wyoming, USA to Edward Thomas Kennaday³²³ and Alice Mannahan³²⁴, as shown in family tree 65. Alice died in 1985, aged about 47.
271. FRANCES AMONDA DAVIDSON (William's great-great-great-granddaughter) was born in 1917 in Denver, Adams, Colorado, USA to Fairfax Harry Davidson³²⁶ and Alice Oda May Kennaday³²⁵, as shown in family tree 66.
272. BRUCE DOUGLAS WHITMAN (William's great-great-great-granddaughter's husband) was born in 1920. (Bruce married three times. He was married to Frances Amonda Davidson²⁷¹, Claudette Irene Corlett⁴⁶² and Lorraine Madden⁴⁶³.)
[See also: Indirectly related via Bruce Douglas Whitman]
 Bruce Douglas Whitman married Frances Amonda Davidson²⁷¹. They had eight children:
 Nelson Chester Whitman¹⁷⁰ in 1939
 Boyd David Whitman¹⁷⁴ in 1940
 Richard Ward Whitman¹⁷⁶ in 1941
 Charlotte Louise Whitman¹⁷⁸ in 1944
 Marcella Ann Whitman¹⁸⁰ in 1946
 Phillis Lana Whitman¹⁸² in 1948
 Laurel Alice Whitman¹⁸⁴ in 1952
 Charles Whitman¹⁸⁷ in 1957
This family is shown as family tree 51.
273. VITA MAUDE DAVIDSON (William's great-great-great-granddaughter) was born in 1918 in Saratoga, Carbon, Wyoming, USA to Fairfax Harry Davidson³²⁶ and Alice Oda May Kennaday³²⁵, as shown in family tree 66. (Vita married three times. She was married to Robert Orrin Rogerson²⁷⁴, Douglas Turner Cairns²⁷⁵ and Vyril M Schilling²⁷⁶.)
274. ROBERT ORRIN ROGERSON (William's great-great-great-granddaughter's husband) was born in 1918.
 Robert Orrin Rogerson married Vita Maude Davidson²⁷³. They had three children:
 Robert Harry Rogerson¹⁸⁸ in 1942
 Wilma Elaine Rogerson¹⁸⁹ in 1948
 Ruth Orrine Rogerson¹⁹⁰ in 1949
This family is shown as family tree 52.
275. DOUGLAS TURNER CAIRNS (William's great-great-great-granddaughter's husband).
 Douglas Turner Cairns married Vita Maude Davidson²⁷³.
276. VYRL M SCHILLING (William's great-great-great-granddaughter's husband).
 Vyril M Schilling married Vita Maude Davidson²⁷³.
277. LOUIZE GERTRUDE DAVIDSON (William's great-great-great-granddaughter) was born in 1920 in Saratoga, Carbon, Wyoming, USA to Fairfax Harry Davidson³²⁶ and Alice Oda May Kennaday³²⁵, as shown in family tree 66.
278. HARVEY ALTON BLACKBURN (William's great-great-great-granddaughter's husband) was born in 1915.
 Harvey Alton Blackburn married Louise Gertrude Davidson²⁷⁷. They had two children:
 Katheryne Louise Blackburn¹⁹² in 1946
 Harvey David Blackburn¹⁹⁴ in 1953
This family is shown as family tree 53.

279. CHESTER CLARK DAVIDSON (William's great-great-great-grandson) was born in 1921 to Fairfax Harry Davidson³²⁶ and Alice Oda May Kennaday³²⁵, as shown in family tree 66.
280. NORMA HILDA DADISMAN (William's great-great-great-grandson's wife).
Chester Clark Davidson²⁷⁹ married Norma Hilda Dadisman. They had two children:
Daniel Clark Davidson¹⁹⁶ in 1949
Jean Marie Davidson¹⁹⁷ in 1954
This family is shown as family tree 54.
281. ELEANORA ALICE DAVIDSON (William's great-great-great-granddaughter) was born in 1923 to Fairfax Harry Davidson³²⁶ and Alice Oda May Kennaday³²⁵, as shown in family tree 66.
282. WALTER CECIL ACKERSON (William's great-great-great-granddaughter's husband) was born in 1913.
Walter Cecil Ackerson married Eleanora Alice Davidson²⁸¹. They had four children:
Garrett David Ackerson¹⁹⁸ in 1943
Terry Walter Ackerson²⁰⁰ in 1945
Wesley Cecil Ackerson²⁰³ in 1947
Danny Ray Ackerson²⁰⁵ in 1948
This family is shown as family tree 55.
283. CHARLES DANIEL DAVIDSON (William's great-great-great-grandson) was born in 1927 to Fairfax Harry Davidson³²⁶ and Alice Oda May Kennaday³²⁵, as shown in family tree 66.
284. EARLENE DEE NOLLER (William's great-great-great-grandson's wife) was born in 1929.
Charles Daniel Davidson²⁸³ married Earlene Dee Noller. They had three children:
Suellen Louise Davidson²⁰⁷ in 1951
Deborah Jeane Davidson²⁰⁹
Charles Noller Davidson²¹² in 1960
This family is shown as family tree 56.
285. MYRTLE RAE DAVIDSON (William's great-great-great-granddaughter) was born in 1929 to Fairfax Harry Davidson³²⁶ and Alice Oda May Kennaday³²⁵, as shown in family tree 66.
(Myrtle married twice. She was married to David Debernardi Harned²⁸⁶ and Ronald Clark Redman²⁸⁷.)
286. DAVID DEBERNARDI HARNED (William's great-great-great-granddaughter's husband).
David Debernardi Harned married Myrtle Rae Davidson²⁸⁵. They had one daughter:
Keren Lynne Harned²¹⁴ in 1963
This family is shown as family tree 57.
287. RONALD CLARK REDMAN (William's great-great-great-granddaughter's husband) was born in 1935.
Ronald Clark Redman married Myrtle Rae Davidson²⁸⁵. They had three children:
Kathleen Marie Redman²¹⁶ in 1965
Kathryn Victoria Redman²²⁰ in 1970
Ronnie Wesley Redman²²¹ in 1974
This family is shown as family tree 58.
288. FRANCES ANN KENNADAY (William's great-great-great-granddaughter) was born to Charles Fredrick Kennaday³²⁷ and Margaret Bays³²⁸, as shown in family tree 67.
289. THOMAS DEAN LUCAS (William's great-great-great-granddaughter's husband).
Thomas Dean Lucas married Frances Ann Kennaday²⁸⁸.
290. JACK LAVOY CAIRNS (William's great-great-great-grandson) was born in 1930 in Rawlins, Carbon, Wyoming, USA to Logan Turner Cairns³³⁰ and Emma Helen Kennaday³²⁹, as shown in family tree 68.
291. BEVERLY ANN JOHNSON (William's great-great-great-grandson's wife) was born in 1928 in Hanna, Carbon, Wyoming, USA.
Jack Lavoy Cairns²⁹⁰ married Beverly Ann Johnson. They had six children:
Linda Ann Cairns²²² in 1950
Christine Marie Cairns²²⁴ in 1951
Jack Lavoy Cairns, Jr. ²²⁶ in 1953
Elizabeth Kay Cairns²²⁸ in 1954
William Wayne Cairns²³⁰ in 1955
Rebecca Gay Cairns²³² in 1956
This family is shown as family tree 59.
292. MARGARET FAUNITA CAIRNS (William's great-great-great-granddaughter) was born in 1933 in Rawlins, Carbon, Wyoming, USA to Logan Turner Cairns³³⁰ and Emma Helen Kennaday³²⁹, as shown in family tree 68.
293. ALBERT NORMAN WILSON (William's great-great-great-granddaughter's husband).

Albert Norman Wilson married Margaret Faunita Cairns²⁹². They had three children:

Richard Norman Wilson²³⁴ in 1953

Kenneth Logan Wilson²³⁵ in 1954

Phyllis Ann Wilson²³⁶ in 1955

This family is shown as family tree 60.

294. DOROTHY LARRAINE CAIRNS (William's great-great-great-granddaughter) was born in 1941 in Rawlins, Carbon, Wyoming, USA to Logan Turner Cairns³³⁰ and Emma Helen Kennaday³²⁹, as shown in family tree 68. Dorothy died in 1942, aged about 1.

295. JUDY ANN CAIRNS (William's great-great-great-granddaughter) was born in 1946 in Rawlins, Carbon, Wyoming, USA to Logan Turner Cairns³³⁰ and Emma Helen Kennaday³²⁹, as shown in family tree 68.

296. CRAIG MARTIN SCHMELING (William's great-great-great-granddaughter's husband) was born in 1945 in Whittemore, Platte, Wyoming, USA.

Craig Martin Schmeling married Judy Ann Cairns²⁹⁵. They had two children:

Tyler Martin Schmeling²³⁸ in 1976

Amy Nichole Schmeling²³⁹ in 1978

This family is shown as family tree 61.

Generation of Great-Great-Grandchildren

297. MARCY KENNEDY (William's great-great-granddaughter) was born to Alferd Shidler³³³ and Mariah Kennedy³³², as shown in family tree 69.

298. EDDIE KENNEDY (William's great-great-grandson) was born to Alferd Shidler³³³ and Mariah Kennedy³³², as shown in family tree 69.

299. ALVIN KENNEDY (William's great-great-grandson) was born to Alferd Shidler³³³ and Mariah Kennedy³³², as shown in family tree 69.

300. BEARTHEY KENNEDY (William's great-great-grandson) was born to Alferd Shidler³³³ and Mariah Kennedy³³², as shown in family tree 69.

301. WILLBER KENNEDY (William's great-great-grandson) was born to Alferd Shidler³³³ and Mariah Kennedy³³², as shown in family tree 69.

302. ADDIE KENNEDY (William's great-great-granddaughter) was born to Alferd Shidler³³³ and Mariah Kennedy³³², as shown in family tree 69.

303. JESSE RUFUS KENNEDY (William's great-great-grandson) was born on 17 May 1885 in Ceder Vale, Chautauqua, Kansas, USA to John Ronnie Kennedy³³⁵ and Nancy Alice Martindale³³⁶, as shown in family tree 70.

304. FAY MCCLURE (William's great-great-grandson's wife).

Jesse Rufus Kennedy³⁰³, aged 24, married Fay McClure on 6 April 1910.

305. FREDRICK FAY KENNEDY (William's great-great-grandson) was born on 21 January 1888 in Ceder Vale, Chautauqua, Kansas, USA to John Ronnie Kennedy³³⁵ and Nancy Alice Martindale³³⁶, as shown in family tree 70. Fredrick died on 29 November 1908, aged 20.

306. SADIE BELL KENNEDY (William's great-great-granddaughter) was born on 2 January 1890 in Ceder Vale, Chautauqua, Kansas, USA to John Ronnie Kennedy³³⁵ and Nancy Alice Martindale³³⁶, as shown in family tree 70. Sadie died on 5 December 1922, aged 32.

307. JAY MCCLURE (William's great-great-granddaughter's husband).

Jay McClure married Sadie Bell Kennedy³⁰⁶, aged 18, on 29 January 1908.

308. LILLIE IRENE KENNEDY (William's great-great-granddaughter) was born on 4 May 1906 in Ceder Vale, Chautauqua, Kansas, USA to John Ronnie Kennedy³³⁵ and Nancy Alice Martindale³³⁶, as shown in family tree 70.

309. ELMER PERRY (William's great-great-granddaughter's husband).

Elmer Perry married Lillie Irene Kennedy³⁰⁸.

310. CLARENCE BLAND KENNEDY (William's great-great-grandson) was born on 9 April 1980 in Ceder Vale, Chautauqua, Kansas, USA to John Ronnie Kennedy³³⁵ and Nancy Alice Martindale³³⁶, as shown in family tree 70.

311. ALICE UNKNOWN (William's great-great-grandson's wife).
Clarence Bland Kennedy³¹⁰ married Alice Unknown.
312. SARAH ELIZABETH KENNADAY (William's great-great-granddaughter) was born on 1 November 1884 in Ceder Vale, Chautauqua, Kansas, USA to Charles Alonzo Kennaday³⁴² and Frances Elizabeth Kennedy³⁴¹, as shown in family tree 71. Sarah died on 1 November 1884 as an infant.
313. ROSA MARIE KENNADAY (William's great-great-granddaughter) was born on 22 January 1886 in Ceder Vale, Chautauqua, Kansas, USA to Charles Alonzo Kennaday³⁴² and Frances Elizabeth Kennedy³⁴¹, as shown in family tree 71. Rosa died on 22 July 1907, aged 21, in Saratoga, Wyoming.
314. FRED PETERS (William's great-great-granddaughter's husband).
Fred Peters married Rosa Marie Kennaday³¹³, aged 18, on 7 March 1904 in Saratoga, Wyoming. They had two children:
Grace Peters²⁴⁰
John Peters²⁴¹
This family is shown as family tree 62.
315. ANNA RUTH KENNADAY (William's great-great-granddaughter) was born on 30 January 1888 in Ceder Vale, Chautauqua, Kansas, USA to Charles Alonzo Kennaday³⁴² and Frances Elizabeth Kennedy³⁴¹, as shown in family tree 71. Anna died on 6 November 1959, aged 71, in Ceder Vale, Chautauqua, Kansas, USA.
316. ED STEWART (William's great-great-granddaughter's husband).
Ed Stewart married Anna Ruth Kennaday³¹⁵, aged 17, on 30 September 1905. They had five children:
Mable Vilote Stewart²⁴² in 1906
Frances Luella Stewart²⁴³ in 1909
George Martin Stewart²⁴⁴ in 1912
Olive Ruth Stewart²⁴⁵ in 1921
Charles Leroy Stewart²⁴⁶ in 1929
This family is shown as family tree 63.
317. ALONSO KENNADAY (William's great-great-grandson) was born on 4 April 1889 in Ceder Vale, Chautauqua, Kansas, USA to Charles Alonzo Kennaday³⁴² and Frances Elizabeth Kennedy³⁴¹, as shown in family tree 71. Alonzo died on 4 April 1889 as an infant.
318. HENRY GEORGE KENNADAY (William's great-great-grandson) was born on 11 May 1890 in Ceder Vale, Chautauqua, Kansas, USA to Charles Alonzo Kennaday³⁴² and Frances Elizabeth Kennedy³⁴¹, as shown in family tree 71. Henry died on 20 May 1901, aged 11.
319. HARRY OTIS KENNADAY (William's great-great-grandson) was born on 8 October 1892 in Saratoga, Carbon, Wyoming, USA to Charles Alonzo Kennaday³⁴² and Frances Elizabeth Kennedy³⁴¹, as shown in family tree 71. Harry died on 25 April 1940, aged 47, in Cheyenne, Laramie, Wyoming, USA. He was buried in Saratoga, Wyoming.
320. ESTER WEIBEL (William's great-great-grandson's wife).
Harry Otis Kennaday³¹⁹ married Ester Weibel.
321. FRANK FOREST KENNADAY (William's great-great-grandson) was born on 6 November 1893 in Saratoga, Carbon, Wyoming, USA to Charles Alonzo Kennaday³⁴² and Frances Elizabeth Kennedy³⁴¹, as shown in family tree 71. Frank died on 11 November 1955, aged 62.
Note: *Forest's dad would get up at 5:00 AM in the morning and get everybody up and delegate chores to all the family even the girls had outside chores. After he delegated the chores he would go and take a nap until breakfast was ready. Forest didn't think that this was fair and even after he was grown he still didn't think this was fair. When Forest was only eleven and his brother Ed was age nine their father got them a job herding sheep. His dad would pick up their check and they wouldn't see a dime of the money. Forest said that these were hard times, especially at night, they were really scared. Forest had just finished the third grade when his dad put him out to work and no more schooling.*
322. MABLE PIERCE (William's great-great-grandson's wife) was born on 5 January 1897 in Denver, Colorado to Thomas Earl Pearce⁴⁶⁶ and Mary Adele Lambs-Cobb⁴⁶⁸. Mable died on 27 May 1940, aged 43, in Saratoga, Carbon, Wyoming, USA.
[See also: Indirectly related via Mable Pierce]
Note: *When Mable and her Sister Alice were small girls their father Thomas and wife Mary Pearce left Denver and moved to Saratoga and homesteaded a piece of land outside of Saratoga toward the Rocky Mountains. It wasn't long after that Mary left Thomas and got custody of us. Thomas didn't stay in Saratoga long and when he decided to leave, he stole the two daughters and took them back to Denver with him. He had to work so he put the girls in an orphanage there and paid for their room and board at the orphanage. We cried for our mother a lot but my sister Alice was a great comfort to me at this time. Alice didn't like spinach so she wouldn't eat it when they put it on her plate. They kept putting it on her plate until she decided to eat it and she learned to like it while she was there. I don't know when Mary got her daughters back, but eventually we were back together in Saratoga, Wyoming. Mary went through the tenth grade in Saratoga at that time that was as far as high school went. She played on the basket ball team at*

Saratoga High . She was also an accomplished horseman. Horses were the only means of transportation when she was growing up. She played a mandolin and had a good singing voice. She sang at her church and sang many solos, but her husband Frank couldn't carry a tune. All of her babies were born at home .

Notes prepared by: Florence Kennaday.

Frank Forest Kennaday³²¹, aged 19, married Mable Pierce, aged 16, on 4 July 1913. They had seven children:

Thomas Earl Kennaday²⁴⁸ in 1914
 Florence Mae Kennaday²⁵⁰ in 1917
 Forest Jack Kennaday²⁵³ in 1919
 Rose Marie Kennaday²⁵⁵ in 1921
 Iva June Kennaday²⁵⁷ in 1923
 Bonnie Jean Kennaday²⁵⁹ in 1925
 Lincoln Frank Kennaday²⁶² in 1928

This family is shown as family tree 64.

323. EDWARD THOMAS KENNADAY (William's great-great-grandson) was born on 9 October 1895 in Saratoga, Carbon, Wyoming, USA to Charles Alonzo Kennaday³⁴² and Frances Elizabeth Kennedy³⁴¹, as shown in family tree 71. Edward died on 16 October 1951, aged 56.

324. ALICE MANNAHAN (William's great-great-grandson's wife) was born in 1900 in Saratoga, Carbon, Wyoming, USA. Alice died in 1956, aged about 56.

Edward Thomas Kennaday³²³, aged 22, married Alice Mannahan, aged about 18, on 11 August 1918. They had seven children:

William C Kennaday²⁶⁴ in 1920
 John E Kennaday²⁶⁵ in 1927
 Mary Lou Kennaday²⁶⁶ in 1931
 Catherine Marie Kennaday²⁶⁷ in 1931
 Fred E Kennaday²⁶⁸ in 1932
 James Kennaday²⁶⁹
 Alice Ann Kennaday²⁷⁰ in 1938

This family is shown as family tree 65.

325. ALICE ODA MAY KENNADAY (William's great-great-granddaughter) was born on 13 April 1897 in Saratoga, Carbon, Wyoming, USA to Charles Alonzo Kennaday³⁴² and Frances Elizabeth Kennedy³⁴¹, as shown in family tree 71. Alice died on 6 December 1979, aged 82, in Rawlins, Carbon, Wyoming, USA.

326. FAIRFAX HARRY DAVIDSON (William's great-great-granddaughter's husband) was born in 1894. Fairfax died in 1967, aged about 73.

Fairfax Harry Davidson, aged about 21, married Alice Oda May Kennaday³²⁵, aged 19, on 11 May 1916. They had seven children:

Frances Amonda Davidson²⁷¹ in 1917
 Vita Maude Davidson²⁷³ in 1918
 Louize Gertrude Davidson²⁷⁷ in 1920
 Chester Clark Davidson²⁷⁹ in 1921
 Eleanora Alice Davidson²⁸¹ in 1923
 Charles Daniel Davidson²⁸³ in 1927
 Myrtle Rae Davidson²⁸⁵ in 1929

This family is shown as family tree 66.

327. CHARLES FREDRICK KENNADAY (William's great-great-grandson) was born on 30 November 1898 in Saratoga, Carbon, Wyoming, USA to Charles Alonzo Kennaday³⁴² and Frances Elizabeth Kennedy³⁴¹, as shown in family tree 71. Charles died on 6 December 1961, aged 63.

328. MARGARET BAYS (William's great-great-grandson's wife).

Charles Fredrick Kennaday³²⁷, aged 34, married Margaret Bays on 18 July 1933. They had one daughter:

Frances Ann Kennaday²⁸⁸

This family is shown as family tree 67.

329. EMMA HELEN KENNADAY (William's great-great-granddaughter) was born on 8 December 1905 in Saratoga, Carbon, Wyoming, USA to Charles Alonzo Kennaday³⁴² and Frances Elizabeth Kennedy³⁴¹, as shown in family tree 71. Emma died on 26 August 1988, aged 82, in Rawlins, Carbon, Wyoming, USA. She was buried in Aug 30, 1988 Rawlins, Wyoming.

330. LOGAN TURNER CAIRNS (William's great-great-granddaughter's husband) was born in 1894 in Rawlins, Carbon, Wyoming, USA. Logan died in 1968, aged about 74.

Logan Turner Cairns, aged about 31, married Emma Helen Kennaday³²⁹, aged 19, on 3 December 1925 in Denver, Denver, Colorado, USA. They had four children:

Jack Lavoy Cairns²⁹⁰ in 1930
 Margaret Faunita Cairns²⁹² in 1933
 Dorothy Lorraine Cairns²⁹⁴ in 1941
 Judy Ann Cairns²⁹⁵ in 1946
This family is shown as family tree 68.

Generation of Great-Grandchildren

331. EMALINE KENNEDY (William's great-granddaughter) was born on 25 October 1852 to Jesse Rufus Kennedy³⁵⁶ and Sarah Ann Ankrom³⁵⁷, as shown in family tree 72. Emaline died on 27 February 1860, aged 7.
332. MARIAH KENNEDY (William's great-granddaughter) was born on 13 March 1854 to Jesse Rufus Kennedy³⁵⁶ and Sarah Ann Ankrom³⁵⁷, as shown in family tree 72. Mariah died on 14 November 1911, aged 57.
333. ALFERD SHIDLER (William's great-granddaughter's husband).
 Alferd Shidler married Mariah Kennedy³³², aged 23, on 20 August 1877. They had six children:
 Marcy Kennedy²⁹⁷
 Eddie Kennedy²⁹⁸
 Alvin Kennedy²⁹⁹
 Bearthey Kennedy³⁰⁰
 Willber Kennedy³⁰¹
 Addie Kennedy³⁰²
This family is shown as family tree 69.
334. NANCH ISABELL KENNEDY (William's great-granddaughter) was born on 25 December 1855 to Jesse Rufus Kennedy³⁵⁶ and Sarah Ann Ankrom³⁵⁷, as shown in family tree 72. Nanch died in March 1860, aged 4.
335. JOHN RONNIE KENNEDY (William's great-grandson) was born on 26 December 1857 in Vinton, Ohio, USA to Jesse Rufus Kennedy³⁵⁶ and Sarah Ann Ankrom³⁵⁷, as shown in family tree 72. John died on 20 January 1926, aged 68.
336. NANCY ALICE MARTINDALE (William's great-grandson's wife) was born on 2 November 1864. Nancy died on 27 August 1952, aged 87, in Polk, Missouri, USA.
 John Ronnie Kennedy³³⁵, aged 24, married Nancy Alice Martindale, aged 17, on 6 September 1882. They had five children:
 Jesse Rufus Kennedy³⁰³ in 1885
 Fredrick Fay Kennedy³⁰⁵ in 1888
 Sadie Bell Kennedy³⁰⁶ in 1890
 Lillie Irene Kennedy³⁰⁸ in 1906
 Clarence Bland Kennedy³¹⁰ in 1980
This family is shown as family tree 70.
337. ANDREW KENNEDY (William's great-grandson) was born on 20 August 1860 in Vinton, Ohio, USA to Jesse Rufus Kennedy³⁵⁶ and Sarah Ann Ankrom³⁵⁷, as shown in family tree 72. Andrew died on 12 September 1929, aged 69.
338. EFFIE BACUS (William's great-grandson's wife).
 Andrew Kennedy³³⁷, aged 21, married Effie Bacus on 9 May 1882.
339. SAMUEL RUFUS KENNEDY (William's great-grandson) was born on 24 October 1862 to Jesse Rufus Kennedy³⁵⁶ and Sarah Ann Ankrom³⁵⁷, as shown in family tree 72. Samuel died on 29 January 1896, aged 33.
340. LILLIE TREDWAY (William's great-grandson's wife).
 Samuel Rufus Kennedy³³⁹, aged 23, married Lillie Tredway on 8 July 1886.
341. FRANCES ELIZABETH KENNEDY (William's great-granddaughter) was born on 19 September 1864 in Zaleski, Vinton, Ohio, USA to Jesse Rufus Kennedy³⁵⁶ and Sarah Ann Ankrom³⁵⁷, as shown in family tree 72. Frances died on 10 June 1938, aged 73, in Saratoga, Carbon, Wyoming, USA. She was buried in June 13 1938 Saratoga, Wyoming.
 Note: *When Frances was five years old, she and her parents moved to Ceder Vale Kansas in 1869. She became a member of the Church of Christ in Ceder Vale.*
342. CHARLES ALONZO KENNADAY (William's great-granddaughter's husband) was born on 8 November 1856 in Clay, Kentucky, USA to John Hudson Kennaday⁴⁸⁶ and Anne Elizabeth Van Orsdel⁴⁸⁸. He became a Rancher, Cowboy, Policeman. Charles died on 6 December 1940, aged 84, in Saratoga, Carbon, Wyoming, USA. He was buried in Dec. 9 1940 at Saratoga, Carbon, Wyoming, USA.
 [See also: *Indirectly related via Charles Alonzo Kennaday*]
 Note: *My brother Billy and sister Emma used to come and visit occasionally. When he was in his twenties he roade the Chisolm Trail on cattle drives where he meet his wife. They were married on November 11, 1883. In 1891 Charles & Frances left Kansas and moved to Saratoga, Wyoming. Charles pursued several occupations there, Rancher, Cowboy & Policeman. Charles also had a brother Jack that settled near Saratoga on a ranch. He had a ranch near his brother on Ceder Creek, not to far from Saratoga, about 16 miles. A mountain peak in that area is named after*

the two brothers. (Kennaday Peak).

Charles Alonzo Kennaday, aged 27, married Frances Elizabeth Kennedy³⁴¹, aged 19, on 11 November 1883 in Cedarvale, Chatauqua, Kansas, USA at Church of Crist. They had eleven children:

Sarah Elizabeth Kennaday³¹² in 1884
 Rosa Marie Kennaday³¹³ in 1886
 Anna Ruth Kennaday³¹⁵ in 1888
 Alonso Kennaday³¹⁷ in 1889
 Henry George Kennaday³¹⁸ in 1890
 Harry Otis Kennaday³¹⁹ in 1892
 Frank Forest Kennaday³²¹ in 1893
 Edward Thomas Kennaday³²³ in 1895
 Alice Oda May Kennaday³²⁵ in 1897
 Charles Fredrick Kennaday³²⁷ in 1898
 Emma Helen Kennaday³²⁹ in 1905

This family is shown as family tree 71.

343. JAMES FRANKLIN KENNEDY (William's great-grandson) was born on 15 November 1866 in Boody, Macon, Illinois to Jesse Rufus Kennedy³⁵⁶ and Sarah Ann Ankrom³⁵⁷, as shown in family tree 72. James died on 21 January 1918, aged 51.

344. LOUISE WHITED (William's great-grandson's wife).

James Franklin Kennedy³⁴³, aged 32, married Louise Whited on 11 March 1899.

345. WILLIAM EDSON KENNEDY (William's great-grandson) was born on 15 October 1868 in Boody, Macon, Illinois to Jesse Rufus Kennedy³⁵⁶ and Sarah Ann Ankrom³⁵⁷, as shown in family tree 72. William died on 12 March 1889, aged 20.

346. GEORGE WASHINGTON KENNEDY (William's great-grandson) was born on 11 October 1870 in Ceder Vale, Chatauqua, Kansas, USA to Jesse Rufus Kennedy³⁵⁶ and Sarah Ann Ankrom³⁵⁷, as shown in family tree 72. George died on 30 March 1931, aged 60.

347. MARY ELIZABETH SKELTON (William's great-grandson's wife) was born on 14 August 1863 in Seligman, Barry, Missouri, USA to James Franklin Skelton⁵³⁶ and Mary Jane Unknown⁵³⁷.

[See also: Indirectly related via Mary Elizabeth Skelton]

George Washington Kennedy³⁴⁶, aged 18, married Mary Elizabeth Skelton, aged 25, on 7 April 1889 in Missouri, USA.

348. SARAH JANE KENNEDY (William's great-granddaughter) was born on 11 December 1872 in Ceder Vale, Chatauqua, Kansas, USA to Jesse Rufus Kennedy³⁵⁶ and Sarah Ann Ankrom³⁵⁷, as shown in family tree 72. Sarah died on 20 March 1880, aged 7.

349. JESSE WIRTZ (William's great-granddaughter) was born to Jesse Rufus Kennedy³⁵⁶ and Sarah Ann Ankrom³⁵⁷, as shown in family tree 72.

Note: *Jesse was raised from infant. And was daughter of Kennaday and Ida Jane Wirts.*

Generation of Grandchildren

350. NANCY KENNEDY (William's granddaughter) was born on 1 January 1821 in Wanesburg, Green, Pennsylvania, USA to John Kennedy³⁶⁵ and Sarah Jane Raynor³⁶⁶, as shown in family tree 73. Nancy died in 1901, aged about 80.

351. BENJAMIN KIRK SHEPHERD (William's granddaughter's husband).

Benjamin Kirk Shepherd married Nancy Kennedy³⁵⁰, aged 21, on 29 December 1842.

352. CHRISTINE KENNEDY (William's granddaughter) was born on 11 July 1822 in Wanesburg, Green, Pennsylvania, USA to John Kennedy³⁶⁵ and Sarah Jane Raynor³⁶⁶, as shown in family tree 73.

353. JACOB KENNEDY (William's grandson) was born on 10 November 1826 in Waynesburg, Green, Pennsylvania USA to John Kennedy³⁶⁵ and Sarah Jane Raynor³⁶⁶, as shown in family tree 73.

354. JAMES LEIGHTON KENNEDY (William's grandson) was born on 10 November 1826 in Waynesburg, Green, Pennsylvania USA to John Kennedy³⁶⁵ and Sarah Jane Raynor³⁶⁶, as shown in family tree 73. James died on 19 March 1875, aged 48.

355. ELIZABETH RHINEHEART (William's grandson's wife). Elizabeth died on 19 March 1875.

James Leighton Kennedy³⁵⁴ married Elizabeth Rhineheart.

356. JESSE RUFUS KENNEDY (William's grandson) was born on 2 March 1831 in Gurnsey, Ohio, USA to John Kennedy³⁶⁵ and Sarah Jane Raynor³⁶⁶, as shown in family tree 73. He became a Pioneer Farmer. Jesse died on 7 August 1899, aged 68, in Ceder Vale, Chatauqua, Kansas, USA.

357. SARAH ANN ANKROM (William's grandson's wife) was born on 12 September 1830 in Green, Pennsylvania, USA to John Ankrom⁵⁴⁹ and Ruth Unknown⁵⁵⁰. Sarah died on 29 March 1920, aged 89, in Ceder Vale, Chautauqua, Kansas, USA.

[See also: Indirectly related via Sarah Ann Ankrom]

Jesse Rufus Kennedy³⁵⁶, aged 20, married Sarah Ann Ankrom, aged 21, on 11 December 1851 in Ohio. They had twelve children:

Emaline Kennedy³³¹ in 1852
 Mariah Kennedy³³² in 1854
 Nanch Isabell Kennedy³³⁴ in 1855
 John Ronnie Kennedy³³⁵ in 1857
 Andrew Kennedy³³⁷ in 1860
 Samuel Rufus Kennedy³³⁹ in 1862
 Frances Elizabeth Kennedy³⁴¹ in 1864
 James Franklin Kennedy³⁴³ in 1866
 William Edson Kennedy³⁴⁵ in 1868
 George Washington Kennedy³⁴⁶ in 1870
 Sarah Jane Kennedy³⁴⁸ in 1872
 Jesse Wirtz³⁴⁹

This family is shown as family tree 72.

358. JONN KENNEDY (William's grandson) was born on 19 June 1833 in Vinton, Ohio, USA to John Kennedy³⁶⁵ and Sarah Jane Raynor³⁶⁶, as shown in family tree 73.

359. LYDIA JARVIS (William's grandson's wife).

Jonn Kennedy³⁵⁸, aged 28, married Lydia Jarvis on 6 October 1861 in Nobel.

360. EMILINE KENNEDY (William's granddaughter) was born on 9 January 1836 in Noble, Ohio, USA to John Kennedy³⁶⁵ and Sarah Jane Raynor³⁶⁶, as shown in family tree 73. Emiline died on 19 May 1923, aged 87.

361. SAMUEL KENNEDY (William's grandson) was born on 28 February 1837 in Zaleski, Vinton, Ohio, USA to John Kennedy³⁶⁵ and Sarah Jane Raynor³⁶⁶, as shown in family tree 73.

362. SARAH JANE KENNEDY (William's granddaughter) was born on 16 June 1840 in Zaleski, Vinton, Ohio, USA to John Kennedy³⁶⁵ and Sarah Jane Raynor³⁶⁶, as shown in family tree 73.

363. ELIZABETH KENNEDY (William's granddaughter) was born on 16 June 1842 to John Kennedy³⁶⁵ and Sarah Jane Raynor³⁶⁶, as shown in family tree 73.

364. REBECCA KENNEDY (William's granddaughter) was born on 9 April 1845 in Vinton, Ohio, USA to John Kennedy³⁶⁵ and Sarah Jane Raynor³⁶⁶, as shown in family tree 73. Rebecca died on 1 January 1882, aged 36.

Generation of Children

365. JOHN KENNEDY (William's son) was born on 9 January 1795 in Dublin, Ireland to William Kennedy³⁶⁷, as shown within family tree 73. He became a Farmer, Soldier in war of 1812. John died on 10 August 1865, aged 70, in JacksoTownsh, Ohio, USA.

366. SARAH JANE RAYNOR (William's daughter-in-law) was born on 10 October 1797 in Waynesburg, Green, Pennsylvania USA to Jake Raynor⁵⁵⁵. Sarah died on 8 April 1888, aged 90.

[See also: Indirectly related via Sarah Jane Raynor]

John Kennedy³⁶⁵, aged about 23, married Sarah Jane Raynor, aged about 20, in 1818. They had eleven children:

Nancy Kennedy³⁵⁰ in 1821
 Christine Kennedy³⁵² in 1822
 Jacob Kennedy³⁵³ in 1826
 James Leighton Kennedy³⁵⁴ in 1826
 Jesse Rufus Kennedy³⁵⁶ in 1831
 Jonn Kennedy³⁵⁸ in 1833
 Emiline Kennedy³⁶⁰ in 1836
 Samuel Kennedy³⁶¹ in 1837
 Sarah Jane Kennedy³⁶² in 1840
 Elizabeth Kennedy³⁶³ in 1842
 Rebecca Kennedy³⁶⁴ in 1845

This family is shown as family tree 73.

Generation of Peers

367. WILLIAM KENNEDY (The subject of this report).
William fathered one son:
 John Kennedy³⁶⁵ in 1795
This family is shown within family tree 73.

5. INDIRECTLY RELATED via BETTY CAROL FITZPATRICK ¹⁵¹
(William's Four-Times-Great-Grandson's wife)

Same generation as William's Great-Great-Great-Grandchildren

368. PETE FITZPATRICK FITZPATRICK (Betty's father).

369. VIRGINIA RUTH GULETT (Betty's mother).

Pete Fitzpatrick Fitzpatrick³⁶⁸ married Virginia Ruth Gulett. They had one daughter:
Betty Carol Fitzpatrick¹⁵¹ in 1947

6. INDIRECTLY RELATED via JOHN DAVID KELLEY ²⁵⁸
(William's Great-Great-Great-Granddaughter's husband)

Same generation as William's Five-Times-Great-Grandchildren

370. GARY SCOTT (John's great-nephew) was born on 3 January 1951 to Pete Scott³⁹⁵ and Dorthy Mae Kelley³⁹⁴.
371. DONNA SCOTT (John's great-niece) was born on 4 August 1959 to Pete Scott³⁹⁵ and Dorthy Mae Kelley³⁹⁴.
372. BOBBY GENE KELLEY (John's great-nephew) was born on 8 August 1954 in Carlisle, Kentucky, USA to Eugene Kelley³⁹⁶ and Opal Unknown³⁹⁷.
373. CHARLES UNKNOWN (John's great-nephew) was born to Mr. Myers⁴⁰⁰ and Juanita Kelley³⁹⁸.
374. CLARENCE UNKNOWN (John's great-nephew) was born to Mr. Myers⁴⁰⁰ and Juanita Kelley³⁹⁸.
375. ELIZABETH FAYE UNKNOWN (John's great-niece) was born to Mr. Myers⁴⁰⁰ and Juanita Kelley³⁹⁸.
376. HAROLED LEE PRUITT, JR. (John's great-nephew) was born to Harold Lee Pruitt⁴⁰² and Mary Elizabeth Kelley⁴⁰¹.
377. DANNY JAMES PRUITT (John's great-nephew) was born to Harold Lee Pruitt⁴⁰² and Mary Elizabeth Kelley⁴⁰¹.
378. RUTH ANN PRUITT (John's great-nephew) was born to Harold Lee Pruitt⁴⁰² and Mary Elizabeth Kelley⁴⁰¹.
379. CRISTINE MAE PRUITT (John's great-niece) was born to Harold Lee Pruitt⁴⁰² and Mary Elizabeth Kelley⁴⁰¹.
380. MICHAEL CAMERON PRUITT (John's great-nephew) was born to Harold Lee Pruitt⁴⁰² and Mary Elizabeth Kelley⁴⁰¹.
381. ALLEN TODD PRUITT (John's great-nephew) was born to Harold Lee Pruitt⁴⁰² and Mary Elizabeth Kelley⁴⁰¹.
382. ROSA E MARY BERRYMAN (John's great-niece) was born on 26 September 1959 to Tommy Berryman⁴⁰⁴ and Wanda Lou Kelley⁴⁰³.
383. GILBART BERRYMAN (John's great-nephew) was born on 20 April 1961 to Tommy Berryman⁴⁰⁴ and Wanda Lou Kelley⁴⁰³.
384. JULIE MAE BERRYMAN (John's great-niece) was born on 2 June 1962 to Tommy Berryman⁴⁰⁴ and Wanda Lou Kelley⁴⁰³. Julie died on 3 September 1963, aged 1.
385. FRED A JEAN BERRYMAN (John's great-niece) was born on 14 September 1963 to Tommy Berryman⁴⁰⁴ and Wanda Lou Kelley⁴⁰³.
386. TOMMY BERRYMAN, II (John's great-nephew) was born on 3 September 1964 to Tommy Berryman⁴⁰⁴ and Wanda Lou Kelley⁴⁰³.
387. BONNIE SUE UNKNOWN (John's great-niece) was born to Mr. Cox⁴⁰⁷ and Cristine Faye Kelley⁴⁰⁵.
388. BILLY JOE UNKNOWN (John's great-nephew) was born to Mr. Cox⁴⁰⁷ and Cristine Faye Kelley⁴⁰⁵.
389. JIMMY UNKNOWN (John's great-nephew) was born to Mr. Cox⁴⁰⁷ and Cristine Faye Kelley⁴⁰⁵.
390. CHIP UNKNOWN (John's great-nephew) was born to Brenda Jane Kelley⁴⁰⁸.
391. KIM UNKNOWN (John's great-niece) was born to Brenda Jane Kelley⁴⁰⁸.
392. AMANDA KELLEY (John's great-niece) was born to Billy Dean Kelley⁴¹² and Ms. Unknown⁴¹³.
393. BILLY DEAN KELLEY (John's great-nephew) was born to Billy Dean Kelley⁴¹² and Ms. Unknown⁴¹³.

Same generation as William's Four-Times-Great-Grandchildren

394. DORTHY MAE KELLEY (John's niece) was born on 3 December 1932 in Carlisle, Kentucky, USA to James Luther Kelley⁴¹⁹ and Cristine Sapp⁴²⁰.
395. PETE SCOTT (John's niece's husband).
Pete Scott married Dorothy Mae Kelley³⁹⁴. They had two children:
Gary Scott³⁷⁰ in 1951
Donna Scott³⁷¹ in 1959
396. EUGENE KELLEY (John's nephew) was born on 25 April 1935 in Carlisle, Kentucky, USA to James Luther Kelley⁴¹⁹ and Cristine Sapp⁴²⁰.
397. OPAL UNKNOWN (John's nephew's wife).
Eugene Kelley³⁹⁶ married Opal Unknown. They had one son:
Bobby Gene Kelley³⁷² in 1954
398. JUANITA KELLEY (John's niece) was born on 15 March 1937 in Carlisle, Kentucky, USA to James Luther Kelley⁴¹⁹ and Cristine Sapp⁴²⁰.
(Juanita married twice. She was married to Mr. Walton³⁹⁹ and Mr. Myers⁴⁰⁰.)
399. MR. WALTON (John's niece's husband).
Mr. Walton married Juanita Kelley³⁹⁸.
400. MR. MYERS (John's niece's husband).
Mr. Myers married Juanita Kelley³⁹⁸. They had three children:
Charles Unknown³⁷³
Clarence Unknown³⁷⁴
Elizabeth Faye Unknown³⁷⁵
401. MARY ELIZABETH KELLEY (John's niece) was born on 2 January 1939 in Carlisle, Kentucky, USA to James Luther Kelley⁴¹⁹ and Cristine Sapp⁴²⁰.
402. HAROLD LEE PRUITT (John's niece's husband).
Harold Lee Pruitt married Mary Elizabeth Kelley⁴⁰¹. They had six children:
Harold Lee Pruitt, Jr.³⁷⁶
Danny James Pruitt³⁷⁷
Ruth Ann Pruitt³⁷⁸
Cristine Mae Pruitt³⁷⁹
Michael Cameron Pruitt³⁸⁰
Allen Todd Pruitt³⁸¹
403. WANDA LOU KELLEY (John's niece) was born on 22 February 1942 in Carlisle, Kentucky, USA to James Luther Kelley⁴¹⁹ and Cristine Sapp⁴²⁰.
404. TOMMY BERRYMAN (John's niece's husband).
Tommy Berryman married Wanda Lou Kelley⁴⁰³. They had five children:
Rosa e Mary Berryman³⁸² in 1959
Gilbart Berryman³⁸³ in 1961
Julie Mae Berryman³⁸⁴ in 1962
Freda Jean Berryman³⁸⁵ in 1963
Tommy Berryman, II³⁸⁶ in 1964
405. CRISTINE FAYE KELLEY (John's niece) was born on 9 December 1945 in Carlisle, Kentucky, USA to James Luther Kelley⁴¹⁹ and Cristine Sapp⁴²⁰.
(Cristine married twice. She was married to Mr. Treadway⁴⁰⁶ and Mr. Cox⁴⁰⁷.)
406. MR. TREADWAY (John's niece's husband).
Mr. Treadway married Cristine Faye Kelley⁴⁰⁵.
407. MR. COX (John's niece's husband).
Mr. Cox married Cristine Faye Kelley⁴⁰⁵. They had three children:
Bonnie Sue Unknown³⁸⁷
Billy Joe Unknown³⁸⁸
Jimmy Unknown³⁸⁹
408. BRENDA JANE KELLEY (John's niece) was born on 25 August 1951 in Carlisle, Kentucky, USA to James Luther Kelley⁴¹⁹ and Cristine Sapp⁴²⁰.
Brenda had two children:
Chip Unknown³⁹⁰
Kim Unknown³⁹¹

409. JAMES LUTHER KELLEY, JR. (John's nephew) was born on 14 February 1953 in Carlisle, Kentucky, USA to James Luther Kelley⁴¹⁹ and Cristine Sapp⁴²⁰.
410. FREDDIE WARREN KELLEY (John's nephew) was born on 24 September 1954 in Carlisle, Kentucky, USA to James Luther Kelley⁴¹⁹ and Cristine Sapp⁴²⁰. Freddie died on 4 November 1956, aged 2, of Drowend, in Carlisle, Kentucky, USA.
411. DONNIE LEE KELLEY (John's nephew) was born on 25 November 1955 in Carlisle, Kentucky, USA to James Luther Kelley⁴¹⁹ and Cristine Sapp⁴²⁰.
412. BILLY DEAN KELLEY (John's nephew) was born on 9 June 1958 in Carlisle, Kentucky, USA to James Luther Kelley⁴¹⁹ and Cristine Sapp⁴²⁰.
413. MS. UNKNOWN (John's nephew's wife).
 Billy Dean Kelley⁴¹² married Ms. Unknown. They had two children:
 Amanda Kelley³⁹²
 Billy Dean Kelley³⁹³
414. WILLIAM BLAINE KELLEY (John's nephew) was born to Talmadge Blane Kelley, Jr.⁴²¹ and Betty Earlywine⁴²².
415. MILDRED ANN KELLEY (John's niece) was born to Talmadge Blane Kelley, Jr.⁴²¹ and Betty Earlywine⁴²².
416. AQUILLA DAVID KELLEY (John's nephew) was born to Talmadge Blane Kelley, Jr.⁴²¹ and Betty Earlywine⁴²².
417. MARY LOU KELLEY (John's niece) was born to Talmadge Blane Kelley, Jr.⁴²¹ and Betty Earlywine⁴²².
418. BEVERLY KELLEY (John's niece) was born to Talmadge Blane Kelley, Jr.⁴²¹ and Betty Earlywine⁴²².

Same generation as William's Great-Great-Great-Grandchildren

419. JAMES LUTHER KELLEY (John's brother) was born on 31 March 1911 to Talmadge Blane Kelley⁴²⁹ and Mary Elizabeth Minton⁴³⁰. James died on 27 March 1956, aged 44, in Carlisle, Kentucky, USA.
420. CRISTINE SAPP (John's sister-in-law) was born on 15 February 1919 to John Harvey Sapp⁵⁶¹ and Mary Miranda Unknown⁵⁶².
[See also: Indirectly related via Cristine Sapp]
 James Luther Kelley⁴¹⁹, aged 21, married Cristine Sapp, aged 13, on 10 June 1932. They had eleven children:
 Dorothy Mae Kelley³⁹⁴ in 1932
 Eugene Kelley³⁹⁶ in 1935
 Juanita Kelley³⁹⁸ in 1937
 Mary Elizabeth Kelley⁴⁰¹ in 1939
 Wanda Lou Kelley⁴⁰³ in 1942
 Cristine Faye Kelley⁴⁰⁵ in 1945
 Brenda Jane Kelley⁴⁰⁸ in 1951
 James Luther Kelley, Jr.⁴⁰⁹ in 1953
 Freddie Warren Kelley⁴¹⁰ in 1954
 Donnie Lee Kelley⁴¹¹ in 1955
 Billy Dean Kelley⁴¹² in 1958
421. TALMADGE BLANE KELLEY, JR. (John's brother) was born on 28 January 1917 to Talmadge Blane Kelley⁴²⁹ and Mary Elizabeth Minton⁴³⁰.
422. BETTY EARLYWINE (John's sister-in-law) was born to Lou Kelley⁵⁶³.
[See also: Indirectly related via Betty Earlywine]
 Talmadge Blane Kelley, Jr.⁴²¹ married Betty Earlywine. They had five children:
 William Blaine Kelley⁴¹⁴
 Mildred Ann Kelley⁴¹⁵
 Aquilla David Kelley⁴¹⁶
 Mary Lou Kelley⁴¹⁷
 Beverly Kelley⁴¹⁸
423. AQUILLA DURHAM KELLEY (John's brother) was born to Talmadge Blane Kelley⁴²⁹ and Mary Elizabeth Minton⁴³⁰.
424. EFRFIE MAE WATKINS (John's cousin) was born to Mr. Watkins⁴³⁵ and Mabel Kelley⁴³⁴.

425. RAYMOND SADLER (John's cousin) was born to Mr. Sadler⁴⁴⁵ and Carrie Minton⁴⁴⁴.
426. JAMES UNKNOWN (John's cousin) was born to Mr. Unknown⁴⁴⁸ and Phillys Minton⁴⁴⁷.
427. EUGENE UNKNOWN (John's cousin) was born to Mr. Unknown⁴⁴⁸ and Phillys Minton⁴⁴⁷.
428. BILL TOM UNKNOWN (John's cousin) was born to Mr. Unknown⁴⁴⁸ and Phillys Minton⁴⁴⁷.

Same generation as William's Great-Great-Grandchildren

429. TALMADGE BLANE KELLEY (John's father) was born on 12 July 1886 to Lewis Kelley⁴⁵¹ and Pamela Frances Bowles⁴⁵². Talmadge died on 6 February 1931, aged 44.
 Note: *Talmadge & wife Mary moved in with Lewis on Mt. Merior Ridge and took care of him for a short time. (Between 1909-1911) Lewis then went from house to house, lived with his children.*
430. MARY ELIZABETH MINTON (John's mother) was born on 28 August 1878 to James M Minton⁴⁵³ and Margaret Johnson⁴⁵⁴. Mary died on 26 January 1961, aged 82, in Carlisle, Kentucky, USA.
 Talmadge Blane Kelley⁴²⁹, aged 23, married Mary Elizabeth Minton, aged 31, on 16 December 1909. They had four children:
 James Luther Kelley⁴¹⁹ in 1911
 Talmadge Blane Kelley, Jr.⁴²¹ in 1917
 John David Kelley²⁵⁸ in 1918
 Aquilla Durham Kelley⁴²³
431. MILTON VARSO KELLEY (John's uncle) was born to Lewis Kelley⁴⁵¹ and Pamela Frances Bowles⁴⁵².
432. HERBERT KELLEY (John's uncle) was born to Lewis Kelley⁴⁵¹ and Pamela Frances Bowles⁴⁵².
433. HERMAN KELLEY (John's uncle) was born to Lewis Kelley⁴⁵¹ and Pamela Frances Bowles⁴⁵².
434. MABEL KELLEY (John's aunt) was born to Lewis Kelley⁴⁵¹ and Pamela Frances Bowles⁴⁵².
435. MR. WATKINS (John's uncle by marriage).
 Mr. Watkins married Mabel Kelley⁴³⁴. They had one daughter:
 Efrfie Mae Watkins⁴²⁴
436. BETTY JANE KELLEY (John's aunt) was born to Lewis Kelley⁴⁵¹ and Pamela Frances Bowles⁴⁵².
437. SILVERINE KELLEY (John's aunt) was born to Lewis Kelley⁴⁵¹ and Pamela Frances Bowles⁴⁵².
438. TONM MC RUTHER (John's uncle by marriage).
 Tonm Mc Ruther married Silverine Kelley⁴³⁷.
439. DELLA MINTON (John's aunt) was born on 26 February 1876 to James M Minton⁴⁵³ and Margaret Johnson⁴⁵⁴.
440. ISABELL MAY MINTON (John's aunt) was born on 15 May 1880 to James M Minton⁴⁵³ and Margaret Johnson⁴⁵⁴.
441. IDA CATHERINE MINTON (John's aunt) was born on 9 May 1882 to James M Minton⁴⁵³ and Margaret Johnson⁴⁵⁴.
442. JAMES MINTON (John's uncle) was born on 7 August 1884 to James M Minton⁴⁵³ and Margaret Johnson⁴⁵⁴.
443. MAGGIE MINTON (John's aunt) was born on 13 April 1886 to James M Minton⁴⁵³ and Margaret Johnson⁴⁵⁴.
444. CARRIE MINTON (John's aunt) was born on 7 June 1888 to James M Minton⁴⁵³ and Margaret Johnson⁴⁵⁴.
445. MR. SADLER (John's uncle by marriage).
 Mr. Sadler married Carrie Minton⁴⁴⁴. They had one son:
 Raymond Sadler⁴²⁵
446. ROSAYELLA MINTON (John's aunt) was born on 7 October 1890 to James M Minton⁴⁵³ and Margaret Johnson⁴⁵⁴.
447. PHILLYS MINTON (John's aunt) was born on 8 October 1892 to James M Minton⁴⁵³ and Margaret Johnson⁴⁵⁴.
448. MR. UNKNOWN (John's uncle by marriage).

Mr. Unknown married Phillys Minton⁴⁴⁷. They had three children:
 James Unknown⁴²⁶
 Eugene Unknown⁴²⁷
 Bill Tom Unknown⁴²⁸

449. WALTER MINTON (John's uncle) was born on 12 August 1894 to James M Minton⁴⁵³ and Margaret Johnson⁴⁵⁴.
 Note: *Lived in Cynthiana, Kentucky had two daughters.*

450. ETHEL MINTON (John's aunt) was born on 1 June 1896 to James M Minton⁴⁵³ and Margaret Johnson⁴⁵⁴.

Same generation as William's Great-Grandchildren

451. LEWIS KELLEY (John's grandfather) was born on 5 February 1852 to William S Kelley⁴⁵⁵ and Elizabeth Smith⁴⁵⁶.
 Lewis died on 25 July 1932, aged 80, in Ad Richeys home in Myers station.

Note: *Lewis Kelley bought house on Mt Merior Ridge with insurance money from Son Herbert who was killed whe he fell from a telephone pole. and son Milton who was a world war vet who died in Dayton, Ohio Hospital neither son was ever married. Lewis walked with a cane. He had leg or legs broke in mill accident with logs. He never had his legs set by a doctor. Lewis's father left his mother (Elizabeth Smith) before Lewis was born never to be heard of again. Elizabeth later married amn named Sparks and had several children. Lewis was raised with his half brothers and sisters.*

452. PAMELIA FRANCES BOWLES (John's grandmother) was born on 2 June 1865.

Lewis Kelley⁴⁵¹, aged 32, married Pamela Frances Bowles, aged 19, on 14 October 1884. They had seven children:
 Talmadge Blane Kelley⁴²⁹ in 1886
 Milton Varso Kelley⁴³¹
 Herbert Kelley⁴³²
 Herman Kelley⁴³³
 Mabel Kelley⁴³⁴
 Betty Jane Kelley⁴³⁶
 Silverine Kelley⁴³⁷

453. JAMES M MINTON (John's grandfather) was born on 3 April 1851. James died on 23 October 1917, aged 66.

Note: *James Minton and Margaret Johnson came from Russell Co. Virginia and were married in Tennessee. (information came from Ant Carrie Sadler taken out of her bible.*

454. MARGARET JOHNSON (John's grandmother) was born on 8 May 1856. Margaret died on 7 March 1938, aged 81.

James M Minton⁴⁵³ married Margaret Johnson in Tennessee. They had eleven children:
 Della Minton⁴³⁹ in 1876
 Mary Elizabeth Minton⁴³⁰ in 1878
 Isabell May Minton⁴⁴⁰ in 1880
 Ida Catherine Minton⁴⁴¹ in 1882
 James Minton⁴⁴² in 1884
 Maggie Minton⁴⁴³ in 1886
 Carrie Minton⁴⁴⁴ in 1888
 Rosayella Minton⁴⁴⁶ in 1890
 Phillys Minton⁴⁴⁷ in 1892
 Walter Minton⁴⁴⁹ in 1894
 Ethel Minton⁴⁵⁰ in 1896

Same generation as William's Grandchildren

455. WILLIAM S KELLEY (John's great-grandfather) was born to Erasmus E Kelley⁴⁵⁷ and Mary Mc Iwoan⁴⁵⁸.

456. ELIZABETH SMITH (John's great-grandmother).

William S Kelley⁴⁵⁵ married Elizabeth Smith on 21 May 1870. They had one son:
 Lewis Kelley⁴⁵¹ in 1852

Same generation as William's Children

457. ERAMUS E KELLEY (John's great-great-grandfather) was born to Edward Kelley⁴⁵⁹ and America Mull⁴⁶⁰.

458. MARY MC IWOAN (John's great-great-grandmother).

Erasmus E Kelley⁴⁵⁷ married Mary Mc Iwoan on 17 March 1856. They had one son:
 William S Kelley⁴⁵⁵

Same generation as William's Peers

459. EDWARD KELLEY (John's great-great-great-grandfather).

Note: *Edward's brother wrote until Dec. 26, 1822. Was probated October term court in 1823. He left everything to his wife Eleanor except \$1.00 to each of his children his will did not mane any children.*

460. AMERICA MULL (John's great-great-great-grandmother).

Edward Kelley⁴⁵⁹ married America Mull on 16 February 1834. They had one son:
Eramus E Kelley⁴⁵⁷

7. INDIRECTLY RELATED via BRUCE DOUGLAS WHITMAN²⁷²
(William's Great-Great-Great-Granddaughter's husband)

Same generation as William's Four-Times-Great-Grandchildren

461. MARCUS PINE WHITMAN (Bruce's son) was born in 1962 to Bruce Douglas Whitman²⁷² and Claudette Irene Corlett⁴⁶².

Same generation as William's Great-Great-Great-Grandchildren

462. CLAUDETTE IRENE CORLETT (Bruce's wife).

Bruce Douglas Whitman²⁷² married Claudette Irene Corlett. They had one son:
Marcus Pine Whitman⁴⁶¹ in 1962

463. LORRAINE MADDEN (Bruce's wife).

Bruce Douglas Whitman²⁷² married Lorraine Madden.

8. INDIRECTLY RELATED via MABLE PIERCE³²²
(William's Great-Great-Grandson's wife)

Same generation as William's Great-Great-Grandchildren

464. ALICE PEARCE (Mable's sister) was born on 28 December 1893 in Denver, Colorado to Thomas Earl Pearce⁴⁶⁶ and Mary Adele Lambs- Cobb⁴⁶⁸.

465. VIRGIE PHIPPS (Mable's half-sister) was born to James Phipps⁴⁶⁷ and Mary Adele Lambs- Cobb⁴⁶⁸.

Same generation as William's Great-Grandchildren

466. THOMAS EARL PEARCE (Mable's father) was born on 6 June 1858 in London, England. He became a Long Distance Runner.

Note: Thomas came to the United States when he was 20 as a long distance runner and he returned to England only once than came back to the United States and settled in Denver, Colorado, where he met Mary. They Thomas was fourteen years older than Mary. When their two girls were young they moved to Saratoga, Wyoming and homesteaded a piece of ground outside of Saratoga toward the Rocky Mountains. Thomas had a brother named Walter and a sister named Elizabeth (Lizzie)

All notes were prepared by: Florence Kenneday.

467. JAMES PHIPPS (Mable's mother's husband) was born in London, England.

James married his indirect relation, Mary Adele Lambs- Cobb⁴⁶⁸.

468. MARY ADELE LAMBS- COBB (Mable's mother) was born on 24 September 1872 in Macon, Missouri.

(Mary married twice. She was married to Thomas Earl Pearce⁴⁶⁶ and James Phipps⁴⁶⁷.)

Note: Not sure which of the two Madin names was her real name and which was the name of the people that raised her. Her Mother was one half Cherokee indian and her father was a white man. She got married while she was in Missouri and in 1888 she again got married to James Phipps. She had two girls, Virgie and I don't know the name of the other girl. When the girls were small Mary, her sister Alice and her husband started for Colorado. They traveled by covered wagon and on the way the younger daughter was bitten by a tarantula and died. Mary and her sister Alice had to leave Missouri because a doctor had advised them to go to a higher and drier climate, as both of them had tuberculosis. Mary's sister finally died from the disease, but Mary lived into her 80's. Mary left Thomas and got custody of the girls, but when Thomas left Saratoga and stole the girls and moved back to Denver where he went to work and put them in an orphanage. I don't know when Mary finally got the girls back but they were eventually back together in Saratoga. While in Saratoga Mary had to earn a living so she became a Practical Nurse to support herself and her daughters.

All Notes were prepared by: Florence Kenneday.

Thomas Earl Pearce⁴⁶⁶ married Mary Adele Lambs- Cobb in Denver, Colorado. They had two children:

Alice Pearce⁴⁶⁴ in 1893

Mable Pierce³²² in 1897

James Phipps⁴⁶⁷ married Mary Adele Lambs- Cobb, aged about 15, in 1888. They had one daughter:

Virgie Phipps⁴⁶⁵

9. INDIRECTLY RELATED via CHARLES ALONZO KENNADAY³⁴²
(William's Great-Granddaughter's husband)

Same generation as William's Great-Great-Grandchildren

469. JACK J KENNADAY (Charles's great-nephew) was born on 18 September 1938 in Saratoga, Carbon, Wyoming, USA to Loyd Andrew Kennaday⁴⁷⁵ and Inez Henderson⁴⁷⁶.
470. CARL L KENNADAY (Charles's great-nephew) was born on 18 December 1940 in Saratoga, Carbon, Wyoming, USA to Loyd Andrew Kennaday⁴⁷⁵ and Inez Henderson⁴⁷⁶.
471. CAROL BRUGUS (Charles's great-nephew's wife).
Carl L Kennaday⁴⁷⁰, aged about 33, married Carol Brugus in 1974.
472. JOY L KENNADAY (Charles's great-niece) was born on 17 April 1942 in Saratoga, Carbon, Wyoming, USA to Loyd Andrew Kennaday⁴⁷⁵ and Inez Henderson⁴⁷⁶.
473. JOHN JENNINGS (Charles's great-niece's husband).
John Jennings married Joy L Kennaday⁴⁷², aged about 19, in 1961.
474. DONALD FAY KENNADAY (Charles's great-nephew) was born on 18 May 1944 in Saratoga, Carbon, Wyoming, USA to Loyd Andrew Kennaday⁴⁷⁵ and Inez Henderson⁴⁷⁶.

Same generation as William's Great-Great-Grandchildren

475. LOYD ANDREW KENNADAY (Charles's nephew) was born on 2 August 1903 in Saratoga, Carbon, Wyoming, USA to Andrew Jackson Kennaday⁴⁸⁴ and Anna Marshal⁴⁸⁵. Loyd died on 10 December 1983, aged 80.
476. INEZ HENDERSON (Charles's nephew's wife) was born on 3 February 1915. Inez died on 22 September 1991, aged 76, in Saratoga, Carbon, Wyoming, USA.
Loyd Andrew Kennaday⁴⁷⁵, aged 34, married Inez Henderson, aged 22, on 23 October 1937 in Saratoga, Carbon, Wyoming, USA. They had four children:
Jack J Kennaday⁴⁶⁹ in 1938
Carl L Kennaday⁴⁷⁰ in 1940
Joy L Kennaday⁴⁷² in 1942
Donald Fay Kennaday⁴⁷⁴ in 1944
477. FAY KENNADAY (Charles's niece) was born on 14 June 1907 in Saratoga, Carbon, Wyoming, USA to Andrew Jackson Kennaday⁴⁸⁴ and Anna Marshal⁴⁸⁵. Fay died on 23 May 1974, aged 66.
Note: *Fay Killed a Bear with a 22 when she was only 12 years old.*

Same generation as William's Great-Grandchildren

478. JAMES EDWARD KENNADAY (Charles's brother) was born on 15 July 1858 in Lexington, Mclean, Illinois, USA to John Hudson Kennaday⁴⁸⁶ and Anne Elizabeth Van Orsdel⁴⁸⁸. James died on 6 June 1934, aged 75.
479. IDA JANE KENNADAY (Charles's sister) was born on 4 April 1861 in Lexington, Mclean, Illinois, USA to John Hudson Kennaday⁴⁸⁶ and Anne Elizabeth Van Orsdel⁴⁸⁸. Ida died on 5 April 1883, aged 22.
480. MARY V KENNADAY (Charles's sister) was born on 12 January 1868 in Cherokee Nation, USA to John Hudson Kennaday⁴⁸⁶ and Anne Elizabeth Van Orsdel⁴⁸⁸. Mary died on 4 October 1869, aged 1.
481. JOHN W KENNADAY (Charles's brother) was born on 5 November 1870 in Springfield, Green, Missouri, USA to John Hudson Kennaday⁴⁸⁶ and Anne Elizabeth Van Orsdel⁴⁸⁸. John died on 19 December 1958, aged 88.
482. ANNE E D KENNADAY (Charles's sister) was born on 29 April 1875 in Lexington, Mclean, Illinois, USA to John Hudson Kennaday⁴⁸⁶ and Anne Elizabeth Van Orsdel⁴⁸⁸. Anne died on 4 October 1960, aged 85.
483. EMMA H KENNADAY (Charles's sister) was born on 10 September 1875 in Windfield, Cowley, Kansas, USA to John Hudson Kennaday⁴⁸⁶ and Anne Elizabeth Van Orsdel⁴⁸⁸.
484. ANDREW JACKSON KENNADAY (Charles's brother) was born on 15 July 1878 in Ceder Vale, Chautauqua, Kansas, USA to John Hudson Kennaday⁴⁸⁶ and Anne Elizabeth Van Orsdel⁴⁸⁸. Andrew died on 8 December 1923, aged 45, in Saratoga, Carbon, Wyoming, USA.
Note: *Brother To Frank. Kennady PK Named after him. At Wyoming Snowy Range.*
485. ANNA MARSHEL (Charles's sister-in-law) was born in 1875. Anna died on 8 December 1960, aged about 85, in Saratoga, Carbon, Wyoming, USA.

Andrew Jackson Kennaday⁴⁸⁴ married Anna Marshel. They had two children:
 Loyd Andrew Kennaday⁴⁷⁵ in 1903
 Fay Kennaday⁴⁷⁷ in 1907

Same generation as William's Grandchildren

486. JOHN HUDSON KENNADAY (Charles's father) was born on 13 June 1825 to James Kennaday⁵¹⁵ and Sarah Hudson⁵¹⁶. John died on 8 November 1912, aged 87.
487. JOHN WILLIAMS (Charles's mother's husband).
 John married his indirect relation, Anne Elizabeth Van Orsdel⁴⁸⁸.
488. ANNE ELIZABETH VAN ORSDEL (Charles's mother) was born on 1 August 1836 in Knox, Indiana, USA to Abram F Van Orsdel, Jr.⁵¹⁷ and Rebecca K Boice⁵¹⁸. Anne died on 10 February 1916, aged 79, in Carbon, Wyoming, USA. She was buried in Kennaday Ranch.
 (Anne married twice. She was married to John Williams⁴⁸⁷ and John Hudson Kennaday⁴⁸⁶.)
 John Williams⁴⁸⁷ married Anne Elizabeth Van Orsdel.
 John Hudson Kennaday⁴⁸⁶, aged 30, married Anne Elizabeth Van Orsdel, aged 19, on 30 August 1855 in Boone, Kentucky, USA. They had eight children:
 Charles Alonzo Kennaday³⁴² in 1856
 James Edward Kennaday⁴⁷⁸ in 1858
 Ida Jane Kennaday⁴⁷⁹ in 1861
 Mary V Kennaday⁴⁸⁰ in 1868
 John W Kennaday⁴⁸¹ in 1870
 Anne E D Kennaday⁴⁸² in 1875
 Emma H Kennaday⁴⁸³ in 1875
 Andrew Jackson Kennaday⁴⁸⁴ in 1878
489. JOSEPH BRYSON KENNADAY (Charles's uncle) was born on 22 February 1823 to James Kennaday⁵¹⁵ and Sarah Hudson⁵¹⁶. Joseph died on 20 May 1899, aged 76.
490. ZARILDA KENNADAY (Charles's aunt) was born on 16 March 1828 to James Kennaday⁵¹⁵ and Sarah Hudson⁵¹⁶.
491. MARY VICKER KENNADAY (Charles's aunt) was born on 18 March 1834 to James Kennaday⁵¹⁵ and Sarah Hudson⁵¹⁶. Mary died on 18 February 1907, aged 72.
492. RACHEL A KENNADAY (Charles's aunt) was born to James Kennaday⁵¹⁵ and Sarah Hudson⁵¹⁶.
493. AXIE KENNADAY (Charles's aunt) was born to James Kennaday⁵¹⁵ and Sarah Hudson⁵¹⁶.
494. ALICE KENNADAY (Charles's aunt) was born to James Kennaday⁵¹⁵ and Sarah Hudson⁵¹⁶.
495. JOSEPH WRIGHT KENNADAY (Charles's uncle) was born to James Kennaday⁵¹⁵ and Sarah Hudson⁵¹⁶.
496. WILLIAM GEORGE VAN ORSDEL (Charles's uncle) was born on 15 December 1827 in Harrisburg, Mercer, Kentucky, USA to Abram F Van Orsdel, Jr.⁵¹⁷ and Rebecca K Boice⁵¹⁸. William died on 19 February 1863, aged 35.
497. SARAH CATTERSON (Charles's aunt by marriage).
 William George Van Orsdel⁴⁹⁶, aged 23, married Sarah Catterson on 22 February 1851.
498. JAMES H VAN ORSDEL (Charles's uncle) was born on 11 February 1830 in Knox, Indiana, USA to Abram F Van Orsdel, Jr.⁵¹⁷ and Rebecca K Boice⁵¹⁸.
499. SALLIE MATOXX (Charles's aunt by marriage).
 James H Van Orsdel⁴⁹⁸, aged 24, married Sallie Matoxx on 22 July 1854.
500. MARY B VAN ORSDEL (Charles's aunt) was born on 21 June 1834 in Knox, Indiana, USA to Abram F Van Orsdel, Jr.⁵¹⁷ and Rebecca K Boice⁵¹⁸. Mary died on 11 March 1914, aged 79.
501. REUBIN THORNHELL (Charles's uncle by marriage).
 Reubin Thornhell married Mary B Van Orsdel⁵⁰⁰.
502. REBECCA ELLEN VAN ORSDEL (Charles's aunt) was born on 24 February 1839 in Lexington, Fayette, Kentucky, USA to Abram F Van Orsdel, Jr.⁵¹⁷ and Rebecca K Boice⁵¹⁸. Rebecca died on 18 January 1921, aged 81.
503. WILLIAM B HEWITT (Charles's uncle by marriage).

William B Hewitt married Rebecca Ellen Van Orsdel⁵⁰², aged 20, on 13 February 1860.

504. MELINDA CATHERINE VAN ORSDEL (Charles's aunt) was born on 14 October 1841 in Lexington, Fayette, Kentucky, USA to Abram F Van Orsdel, Jr.⁵¹⁷ and Rebecca K Boice⁵¹⁸. Melinda died on 6 June 1934, aged 92.

505. JOHN BENJAMIN POLLARD (Charles's uncle by marriage).

John Benjamin Pollard married Melinda Catherine Van Orsdel⁵⁰⁴, aged 20, on 31 December 1861.

506. SARAH E VAN ORSDEL (Charles's aunt) was born on 31 August 1843 in Cynthiana, Scott, Kentucky, USA to Abram F Van Orsdel, Jr.⁵¹⁷ and Rebecca K Boice⁵¹⁸. Sarah died on 27 February 1895, aged 51.

(Sarah married twice. She was married to Thomas Rogers⁵⁰⁷ and Noah Diehl⁵⁰⁸.)

507. THOMAS ROGERS (Charles's uncle by marriage).

Thomas Rogers married Sarah E Van Orsdel⁵⁰⁶, aged 24, on 3 July 1868.

508. NOAH DIEHL (Charles's uncle by marriage).

Noah Diehl married Sarah E Van Orsdel⁵⁰⁶, aged 44, on 13 June 1888.

509. ABRAM VAN ORSDEL (Charles's uncle) was born on 31 December 1845 in Bourbon, Kentucky, USA to Abram F Van Orsdel, Jr.⁵¹⁷ and Rebecca K Boice⁵¹⁸. Abram died on 4 January 1846 as an infant.

510. ISABELL VAN ORSDEL (Charles's aunt) was born on 1 December 1846 in Cynthiana, Scott, Kentucky, USA to Abram F Van Orsdel, Jr.⁵¹⁷ and Rebecca K Boice⁵¹⁸. Isabell died on 24 March 1890, aged 43.

511. JAMES H WALLACE (Charles's uncle by marriage).

James H Wallace married Isabell Van Orsdel⁵¹⁰, aged 20, on 25 December 1866.

512. HENERY GEORGE VAN ORSDEL (Charles's uncle) was born on 17 June 1849 in Owen, Kentucky, USA to Abram F Van Orsdel, Jr.⁵¹⁷ and Rebecca K Boice⁵¹⁸.

(Henry married twice. He was married to Annie E Mitchell⁵¹³ and Mattie Anderson⁵¹⁴.)

513. ANNIE E MITCHELL (Charles's aunt by marriage).

Henry George Van Orsdel⁵¹², aged about 17, married Annie E Mitchell in 1866.

514. MATTIE ANDERSON (Charles's aunt by marriage).

Henry George Van Orsdel⁵¹², aged about 28, married Mattie Anderson in 1877.

Same generation as William's Children

515. JAMES KENNADAY (Charles's grandfather) was born in Dublin, Ireland. James died on 5 May 1855.

516. SARAH HUDSON (Charles's grandmother).

James Kennaday⁵¹⁵ married Sarah Hudson. They had eight children:

Joseph Bryson Kennaday⁴⁸⁹ in 1823

John Hudson Kennaday⁴⁸⁶ in 1825

Zarilda Kennaday⁴⁹⁰ in 1828

Mary Vicker Kennaday⁴⁹¹ in 1834

Rachel A Kennaday⁴⁹²

Axie Kennaday⁴⁹³

Alice Kennaday⁴⁹⁴

Joseph Wright Kennaday⁴⁹⁵

517. ABRAM F VAN ORSDEL, JR. (Charles's grandfather) was born in 1808 to Abram Van Orsdel Van Orsdel⁵³¹ and Ellen Unknown⁵³². Abram died in 1849, aged about 41.

518. REBECCA K BOICE (Charles's grandmother) was born on 16 April 1810 in Harrisburg, Mercer, Kentucky, USA to Ephriam Boice⁵³³ and Mary Vicker Smock⁵³⁴. Rebecca died on 6 April 1900, aged 89, in Clay, City Powel, Kentucky, USA.

Abram F Van Orsdel, Jr.⁵¹⁷, aged about 18, married Rebecca K Boice, aged 16, on 27 February 1827. They had ten children:

William George Van Orsdel⁴⁹⁶ in 1827

James H Van Orsdel⁴⁹⁸ in 1830

Mary B Van Orsdel⁵⁰⁰ in 1834

Anne Elizabeth Van Orsdel⁴⁸⁸ in 1836

Rebecca Ellen Van Orsdel⁵⁰² in 1839

Melinda Catherine Van Orsdel⁵⁰⁴ in 1841

Sarah E Van Orsdel⁵⁰⁶ in 1843

Abram Van Orsdel⁵⁰⁹ in 1845

Isabell Van Orsdel⁵¹⁰ in 1846

Henry George Van Orsdel⁵¹² in 1849

519. MARY B BOICE (Charles's great-aunt) was born to Ephriam Boice⁵³³ and Mary Vicker Smock⁵³⁴.
520. GIDEON WOOD (Charles's great-uncle by marriage).
Gideon Wood married Mary B Boice⁵¹⁹ in 1820 in Harrisburg, Mercer, Kentucky, USA.
521. KATIE BOICE (Charles's great-aunt) was born in Harrisburg, Mercer, Kentucky, USA to Ephriam Boice⁵³³ and Mary Vicker Smock⁵³⁴.
522. SAMUEL RYNEARSON (Charles's great-uncle by marriage).
Samuel Rynearson married Katie Boice⁵²¹.
523. JACOB BOICE (Charles's great-uncle) was born in Harrisburg, Mercer, Kentucky, USA to Ephriam Boice⁵³³ and Mary Vicker Smock⁵³⁴.
524. JANE VAN ORSEDEL (Charles's great-aunt by marriage).
Jacob Boice⁵²³ married Jane Van Orsedel.
525. GEORGE SCOMP (Charles's great-uncle) was born to Jacob Scomp⁵³⁵ and Mary Vicker Smock⁵³⁴.
526. JOHN SCOMP (Charles's great-uncle) was born to Jacob Scomp⁵³⁵ and Mary Vicker Smock⁵³⁴.
527. HENRY SCOMP (Charles's great-uncle) was born to Jacob Scomp⁵³⁵ and Mary Vicker Smock⁵³⁴.
528. ANNIE E SCOMP (Charles's great-aunt) was born to Jacob Scomp⁵³⁵ and Mary Vicker Smock⁵³⁴.
529. SALLY SCOMP (Charles's great-aunt) was born to Jacob Scomp⁵³⁵ and Mary Vicker Smock⁵³⁴.
530. HANNA SCOMP (Charles's great-aunt) was born to Jacob Scomp⁵³⁵ and Mary Vicker Smock⁵³⁴.

Same generation as William's Peers

531. ABRAM VAN ORSDEL VAN ORSDEL (Charles's great-grandfather).
532. ELLEN UNKNOWN (Charles's great-grandmother).
Abram Van Orsdel Van Orsdel⁵³¹ married Ellen Unknown. They had one son:
Abram F Van Orsdel, Jr.⁵¹⁷ in 1808
533. EPHRIAM BOICE (Charles's great-grandfather).
534. MARY VICKER SMOCK (Charles's great-grandmother).
(Mary married twice. She was married to Ephriam Boice⁵³³ and Jacob Scomp⁵³⁵.)
Ephriam Boice⁵³³ married Mary Vicker Smock. They had four children:
Rebecca K Boice⁵¹⁸ in 1810
Mary B Boice⁵¹⁹
Katie Boice⁵²¹
Jacob Boice⁵²³
535. JACOB SCOMP (Charles's great-grandmother's husband) was born in New Jersey, USA.
Jacob Scomp married Mary Vicker Smock⁵³⁴. They had six children:
George Scomp⁵²⁵
John Scomp⁵²⁶
Henry Scomp⁵²⁷
Annie E Scomp⁵²⁸
Sally Scomp⁵²⁹
Hanna Scomp⁵³⁰

10. INDIRECTLY RELATED via MARY ELIZABETH SKELTON ³⁴⁷
(William's Great-Grandson's wife)

Same generation as William's Grandchildren

536. JAMES FRANKLIN SKELTON (Mary's father).

537. MARY JANE UNKNOWN (Mary's mother).

James Franklin Skelton⁵³⁶ married Mary Jane Unknown. They had one daughter:
Mary Elizabeth Skelton³⁴⁷ in 1863

11. INDIRECTLY RELATED via SARAH ANN ANKROM³⁵⁷
(William's Grandson's wife)

Same generation as William's Grandchildren

538. RICHARD ANKROM (Sarah's brother) was born on 5 February 1827 in Green, Pennsylvania, USA to John Ankrom⁵⁴⁹ and Ruth Unknown⁵⁵⁰.
539. SOLOMON ANKROM (Sarah's brother) was born on 8 August 1828 in Green, Pennsylvania, USA to John Ankrom⁵⁴⁹ and Ruth Unknown⁵⁵⁰. Solomon died on 2 June 1850, aged 21.
540. JOHN ELLERY ANKROM (Sarah's brother) was born on 2 June 1833 in Green, Pennsylvania, USA to John Ankrom⁵⁴⁹ and Ruth Unknown⁵⁵⁰. John died on 14 June 1850, aged 17.
541. MARY ANN ANKROM (Sarah's sister) was born on 14 July 1835 to John Ankrom⁵⁴⁹ and Ruth Unknown⁵⁵⁰.
542. MARTHA ANN ANKROM (Sarah's sister) was born on 4 November 1837 in Green, Pennsylvania, USA to John Ankrom⁵⁴⁹ and Ruth Unknown⁵⁵⁰. Martha died on 24 June 1855, aged 17.
543. WILLIAM ANKROM (Sarah's brother) was born on 7 April 1840 in Green, Pennsylvania, USA to John Ankrom⁵⁴⁹ and Ruth Unknown⁵⁵⁰.
544. URIAH ANKROM (Sarah's brother) was born on 29 May 1842 in Green, Pennsylvania, USA to John Ankrom⁵⁴⁹ and Ruth Unknown⁵⁵⁰. Uriah died on 3 March 1860, aged 17.
545. ELIZABETH ANKROM (Sarah's sister) was born on 27 June 1844 in Green, Pennsylvania, USA to John Ankrom⁵⁴⁹ and Ruth Unknown⁵⁵⁰.
546. MIRIAH ANKROM (Sarah's sister) was born on 28 December 1846 in Green, Pennsylvania, USA to John Ankrom⁵⁴⁹ and Ruth Unknown⁵⁵⁰.
547. CLEMENTINE ANKROM (Sarah's sister) was born on 21 November 1848 in Green, Pennsylvania, USA to John Ankrom⁵⁴⁹ and Ruth Unknown⁵⁵⁰. Clementine died on 8 April 1866, aged 17.
548. THOMAS ANKROM (Sarah's brother) was born on 1 May 1853 in Green, Pennsylvania, USA to John Ankrom⁵⁴⁹ and Ruth Unknown⁵⁵⁰.

Same generation as William's Children

549. JOHN ANKROM (Sarah's father) was born on 9 August 1809 in Green, Pennsylvania, USA to William Ankrom⁵⁵¹ and Mary Eagor⁵⁵². John died on 12 May 1887, aged 77.
550. RUTH UNKNOWN (Sarah's mother) was born on 2 April 1807 to Joseph Ankrom⁵⁵³ and Elizabeth Sellers⁵⁵⁴. John Ankrom⁵⁴⁹, aged 16, married Ruth Unknown, aged 19, on 7 May 1826. They had twelve children:
- Richard Ankrom⁵³⁸ in 1827
 - Solomon Ankrom⁵³⁹ in 1828
 - Sarah Ann Ankrom³⁵⁷ in 1830
 - John Ellery Ankrom⁵⁴⁰ in 1833
 - Mary Ann Ankrom⁵⁴¹ in 1835
 - Martha Ann Ankrom⁵⁴² in 1837
 - William Ankrom⁵⁴³ in 1840
 - Uriah Ankrom⁵⁴⁴ in 1842
 - Elizabeth Ankrom⁵⁴⁵ in 1844
 - Miriah Ankrom⁵⁴⁶ in 1846
 - Clementine Ankrom⁵⁴⁷ in 1848
 - Thomas Ankrom⁵⁴⁸ in 1853

Same generation as William's Peers

551. WILLIAM ANKROM (Sarah's grandfather).
552. MARY EAGOR (Sarah's grandmother).
William Ankrom⁵⁵¹ married Mary Eagor. They had one son:
John Ankrom⁵⁴⁹ in 1809
553. JOSEPH ANKROM (Sarah's grandfather).

554. ELIZABETH SELLERS (Sarah's grandmother).

Joseph Ankrom⁵⁵³ married Elizabeth Sellers. They had one daughter:
Ruth Unknown⁵⁵⁰ in 1807

12. INDIRECTLY RELATED via SARAH JANE RAYNOR³⁶⁶
(William's Daughter-in-law)

Same generation as William's Peers

555. JAKE RAYNOR (Sarah's father).
Jake fathered one daughter:
Sarah Jane Raynor³⁶⁶ in 1797

13. INDIRECTLY RELATED via CRISTINE SAPP⁴²⁰
(John David Kelley's Sister-in-law)

Same generation as William's Great-Great-Grandchildren

556. EVERETT SAPP (Cristine's brother) was born to John Harvey Sapp⁵⁶¹ and Mary Miranda Unknown⁵⁶².
557. LIZZIE SAPP (Cristine's sister) was born to John Harvey Sapp⁵⁶¹ and Mary Miranda Unknown⁵⁶².
558. ARCHIE SAPP (Cristine's brother) was born to John Harvey Sapp⁵⁶¹ and Mary Miranda Unknown⁵⁶².
559. ROY SAPP (Cristine's brother) was born to John Harvey Sapp⁵⁶¹ and Mary Miranda Unknown⁵⁶².
560. CLARA BELLE SAPP (Cristine's sister) was born to John Harvey Sapp⁵⁶¹ and Mary Miranda Unknown⁵⁶².

Same generation as William's Great-Great-Grandchildren

561. JOHN HARVEY SAPP (Cristine's father). John died on 18 December 1958.
562. MARY MIRANDA UNKNOWN (Cristine's mother). Mary died in 1946.
- John Harvey Sapp⁵⁶¹ married Mary Miranda Unknown. They had six children:
- Cristine Sapp⁴²⁰ in 1919
 - Everett Sapp⁵⁵⁶
 - Lizzie Sapp⁵⁵⁷
 - Archie Sapp⁵⁵⁸
 - Roy Sapp⁵⁵⁹
 - Clara Belle Sapp⁵⁶⁰

14. INDIRECTLY RELATED via BETTY EARLYWINE⁴²²
(John David Kelley's Sister-in-law)

Same generation as William's Great-Great-Grandchildren

563. LOU KELLEY (Betty's mother).

Lou Kelley was married. She had one daughter:

Betty Earlywine⁴²²

15. FAMILY TREES

The following family trees each show the reported children, parents, grandparents and great-grandparents of a family group. In order to reduce redundancy, any family group which is wholly included within another family tree may not be reported separately.

Above each of the great-grandparent boxes (top row), a continuation family tree reference number in angle brackets is shown if the great-grandparent is recorded as a child in the continuation tree. A continuation reference number is also shown to the left of a grandparent or parent box if that individual has siblings reported in the continuation tree; and beneath a child box (bottom row) if that individual has children reported in the continuation tree.

In cases of multiple marriages, a continuation reference number preceded by "=" is shown to the right of a parent box. This number references the previous and/or next tree in which that individual is shown with another partner.

1. BOYD, James Vencent & SOBO, Brenda Sue
2. SOBO, Randy Eugene & JOHNSON, Kim Eileen
3. KENNADAY, Todd & JORGENSEN, Joyce Ellen
4. HUNNICUTT, Cristian & KELLEY, Lisa June
5. ASBURY, James Mickel & KELLEY, Lisa June
6. LETT, Tim & CURTIS, Anita Carol
7. CURTIS, David Earl & BENNER, Toni
8. SOBO, Cornell Alexander, Jr. & KENNADAY, Charlotte Arlene
9. KENNADAY, Thomas Eugene & BENSON, Janice
10. GEPPERT, August Henry & KENNADAY, Patty Ray
11. RAMSEY, Earl Efton (Butch) & HUBBARD, Rosa L
12. HAYES, Bob & RAMSEY, Afton Ernstine (Marier)
13. KENNADAY, Jack Wayne & BRANT, Carol Lee
14. KENNADAY, Gary Forrest & THOMPSON, Alice
15. KENNADAY, Michael Joseph & WILLIAMS, Carolyn
16. LOTT, Jimmy Ray & DOLLAR HYDE, Ellen
17. BLUNT, Al & LOTT, Rosa Lee
18. LOTT, Calvin Jay & STURGESS, Jo Ann
19. SLOANE, Mr. & LOTT, Mable Bea
20. KELLEY, Ronald David, Sr. & FITZPATRICK, Betty Carol
21. CURTIS, Norman Perry & KELLEY, Carolyn June
22. JOHNSON, Gordon & MARIER, Sherry Jean
23. FORRESTER, Micheal A & MARIER, Jane Marie
24. KENNADAY, David Debernardi & SMITH, Paula Jo
25. KENNADAY, Steven Scott & LAVELLE, Catherine Susan
26. KENNADAY, Steven Scott & REED, Danielle
27. KENNADAY, Fredrick Frank & YOUNG, Brigid Ann
28. WHITMAN, Nelson Chester & PENDERGRASS, Cecelia Kay
29. WHITMAN, Nelson Chester & CORLETT, Claudette Irene
30. WHITMAN, Boyd David & THOMPSON, Carolyn M
31. WHITMAN, Richard Ward & JOUETT, Robin Knipp
32. BARTLETT, Joseph Grant & WHITMAN, Charlotte Louize
33. THOMPSON, Tommy M & WHITMAN, Marcella Ann
34. SMITH, Fred Winton & WHITMAN, Phillis Lana
35. SELF, Stanley Howard & WHITMAN, Laurel Alice
36. PAGE, Ronald Otis & CAIRNS, Linda Ann
37. CAMPBELL, Craig & CAIRNS, Christine Marie
38. CAIRNS, Jack Lavoy, Jr. & CASSLER, Rebecca
39. HANSEN, Alan & CAIRNS, Elizabeth Kay
40. CAIRNS, William Wayne & PORTER, Kae
41. COOPER, John Ellery & CAIRNS, Rebecca Gay
42. JEBENS, Carlie & WILSON, Phyllis Ann
43. KENNADAY, Thomas Earl & REAM, Gladys Eleanor
44. RAMSEY, Earl N & KENNADAY, Florence Mae
45. STOCKWELL, Ellen (Dude) & KENNADAY, Forest Jack
46. LOTT, Calvin & KENNADAY, Rose Marie
47. KELLEY, John David & KENNADAY, Iva June
48. JOHNSON, Gordon & KENNADAY, Bonnie Jean
49. MARIER, James Martin & KENNADAY, Bonnie Jean
50. KENNADAY, Lincoln Frank & DEBERNARDI, Joan Olivia
51. WHITMAN, Bruce Douglas & DAVIDSON, Frances Amonda

52. ROGERSON, Robert Orrin & DAVIDSON, Vita Maude
53. BLACKBURN, Harvey Alton & DAVIDSON, Louize Gertrude
54. DAVIDSON, Chester Clark & DADISMAN, Norma Hilda
55. ACKERSON, Walter Cecil & DAVIDSON, Eleanora Alice
56. DAVIDSON, Charles Daniel & NOLLER, Earlene Dee
57. HARNED, David Debernardi & DAVIDSON, Myrtle Rae
58. REDMAN, Ronald Clark & DAVIDSON, Myrtle Rae
59. CAIRNS, Jack Lavoy & JOHNSON, Beverly Ann
60. WILSON, Albert Norman & CAIRNS, Margaret Faunita
61. SCHMELING, Craig Martin & CAIRNS, Judy Ann
62. PETERS, Fred & KENNADAY, Rosa Marie
63. STEWART, Ed & KENNADAY, Anna Ruth
64. KENNADAY, Frank Forest & PIERCE, Mable
65. KENNADAY, Edward Thomas & MANNAHAN, Alice
66. DAVIDSON, Fairfax Harry & KENNADAY, Alice Oda May
67. KENNADAY, Charles Fredrick & BAYS, Margaret
68. CAIRNS, Logan Turner & KENNADAY, Emma Helen
69. SHIDLER, Alferd & KENNEDY, Mariah
70. KENNEDY, John Ronnie & MARTINDALE, Nancy Alice
71. KENNADAY, Charles Alonzo & KENNEDY, Frances Elizabeth
72. KENNEDY, Jesse Rufus & ANKROM, Sarah Ann
73. KENNEDY, John & RAYNOR, Sarah Jane

1. James Vencent Boyd & Brenda Sue Sobo

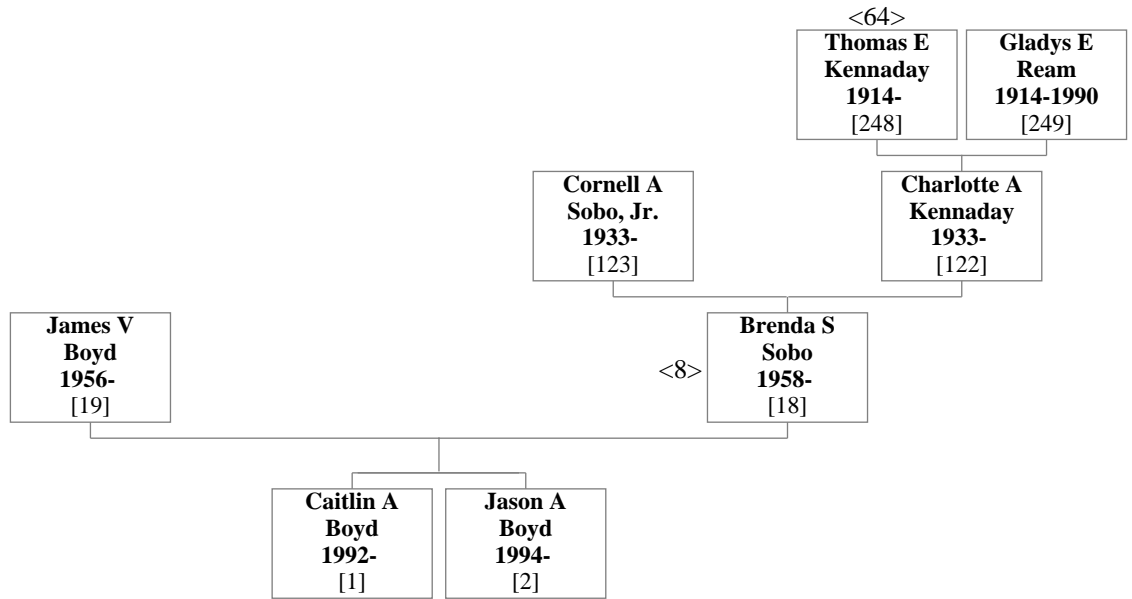

2. Randy Eugene Sobo & Kim Eileen Johnson

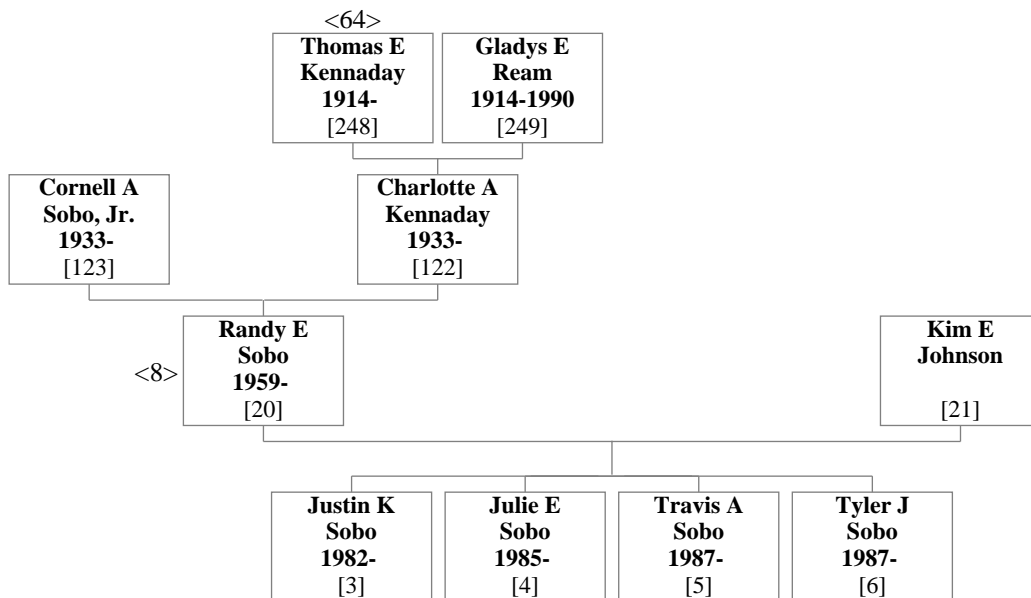

3. Todd Kennaday & Joyce Ellen Jorgensen

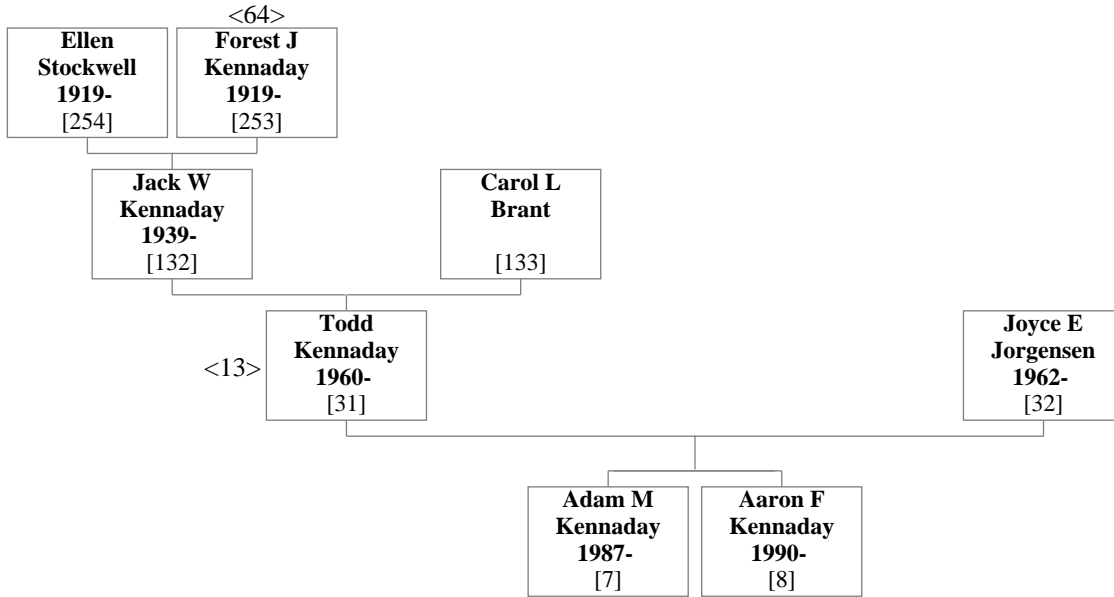

4. Cristian Hunnicutt & Lisa June Kelley

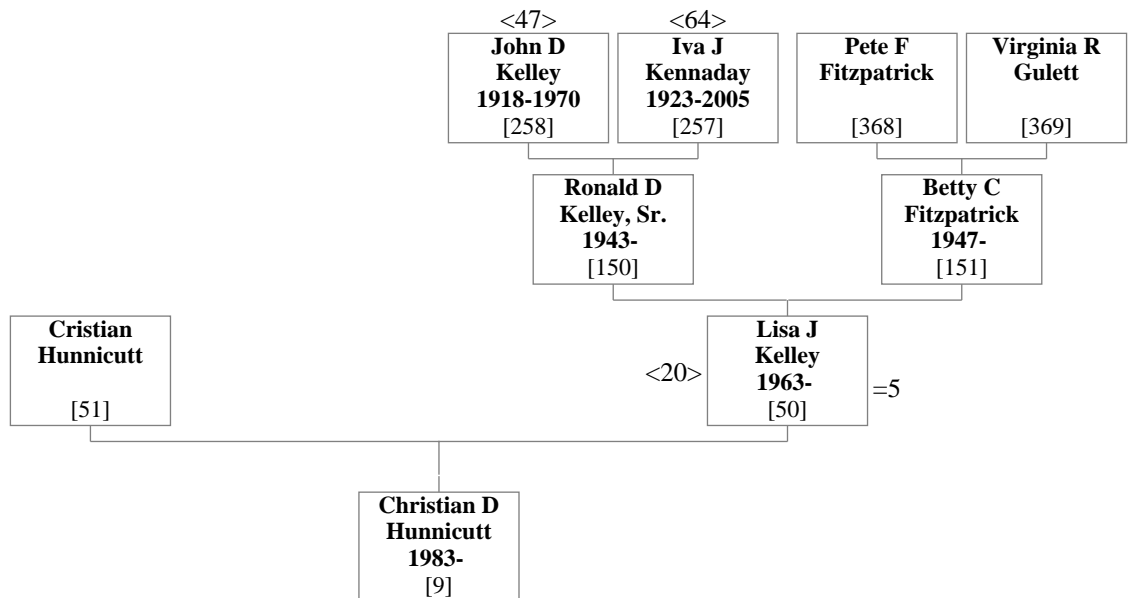

5. James Mickel Asbury & Lisa June Kelley

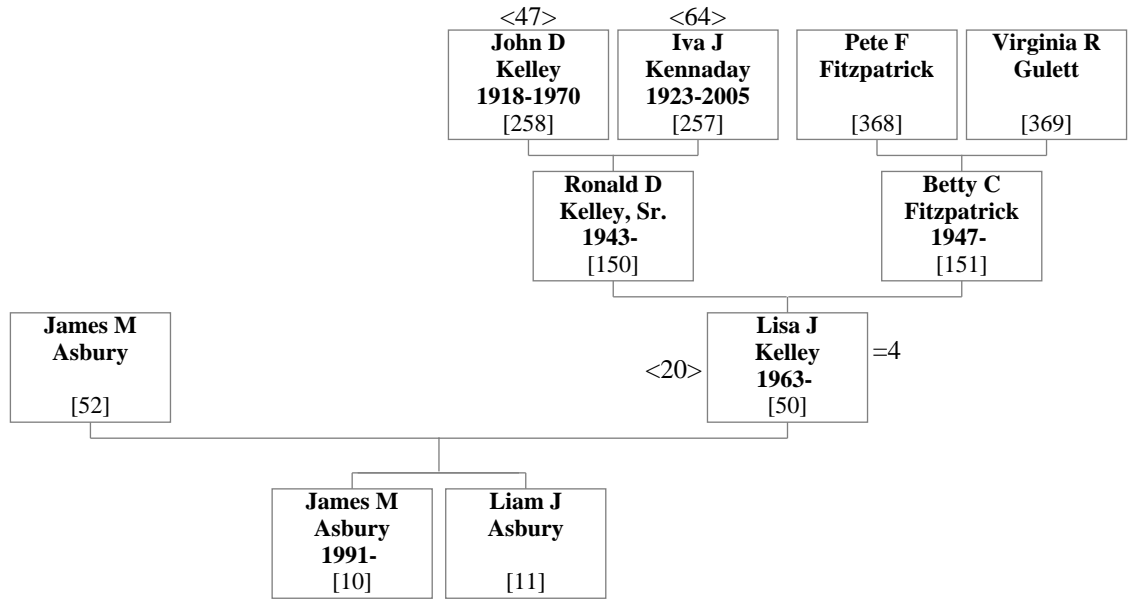

6. Tim Lett & Anita Carol Curtis

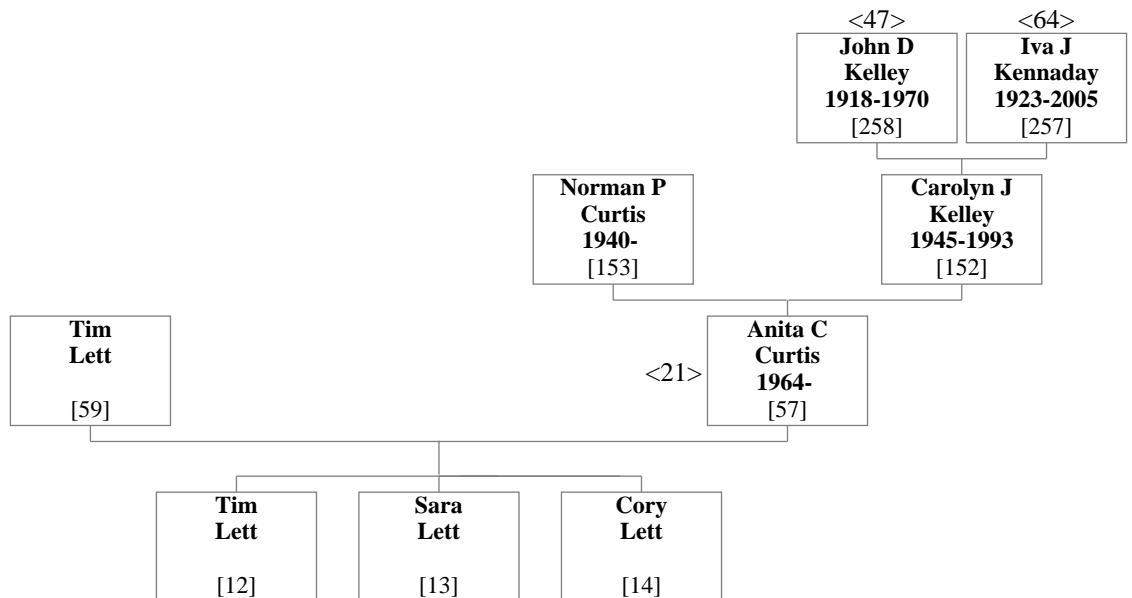

9. Thomas Eugene Kennaday & Janice Benson

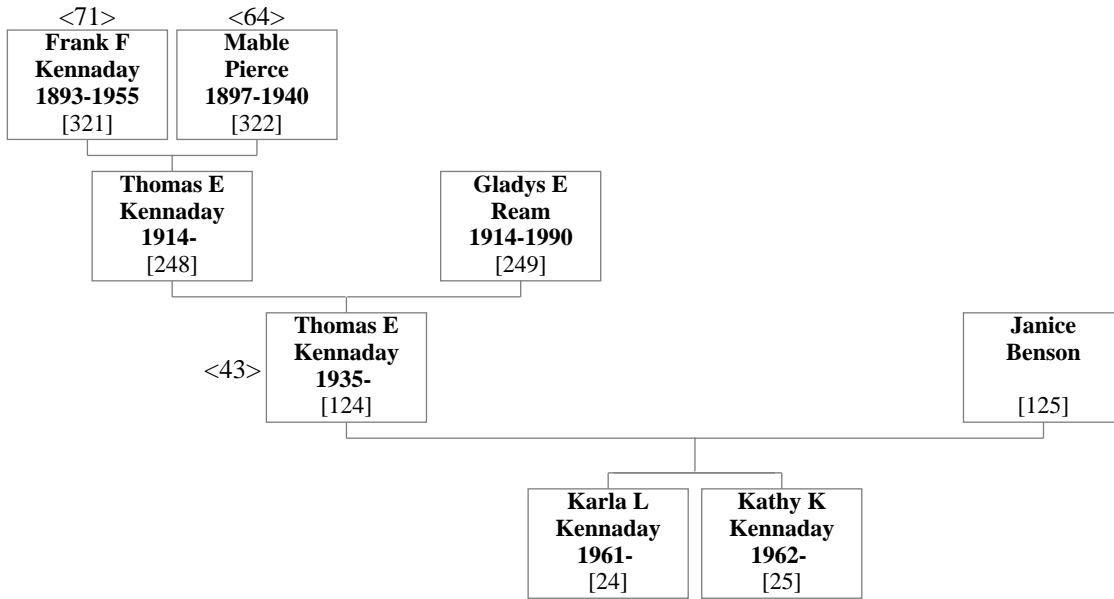

10. August Henry Geppert & Patty Ray Kennaday

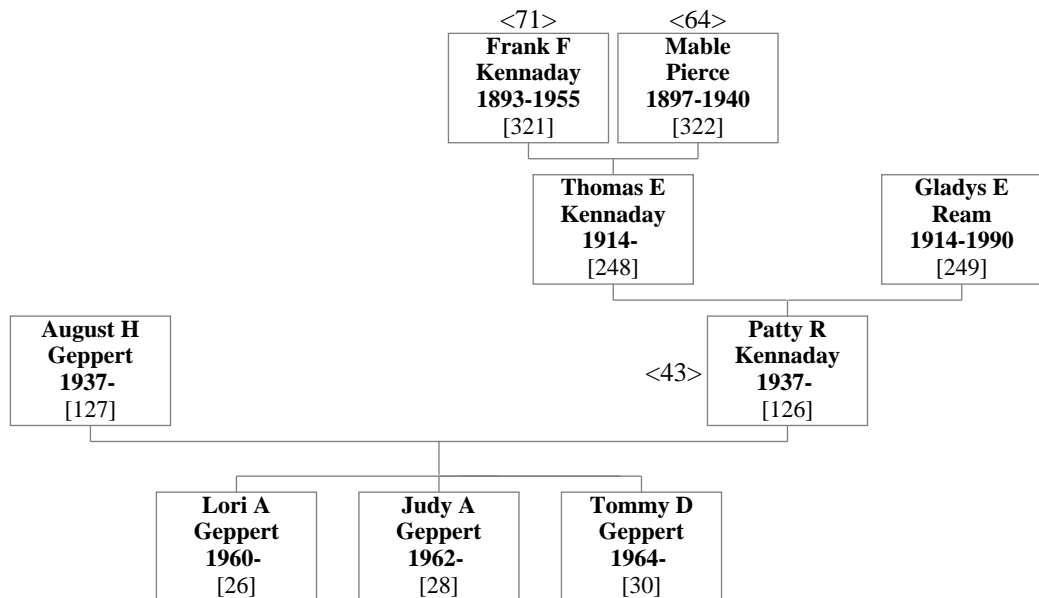

11. Earl Efton (Butch) Ramsey & Rosa L Hubbard

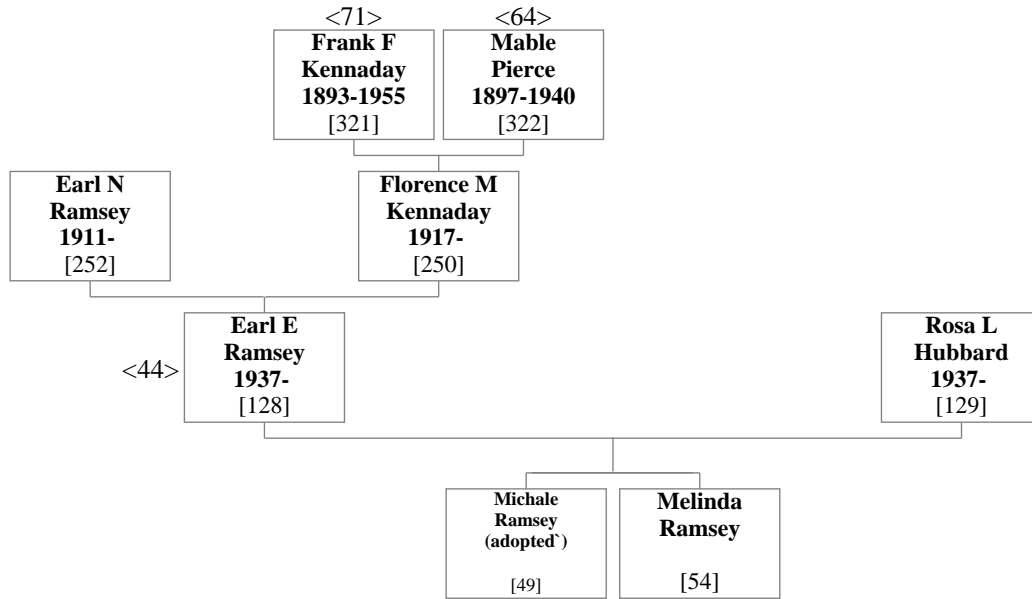

12. Bob Hayes & Afton Ernstine (Marier) Ramsey

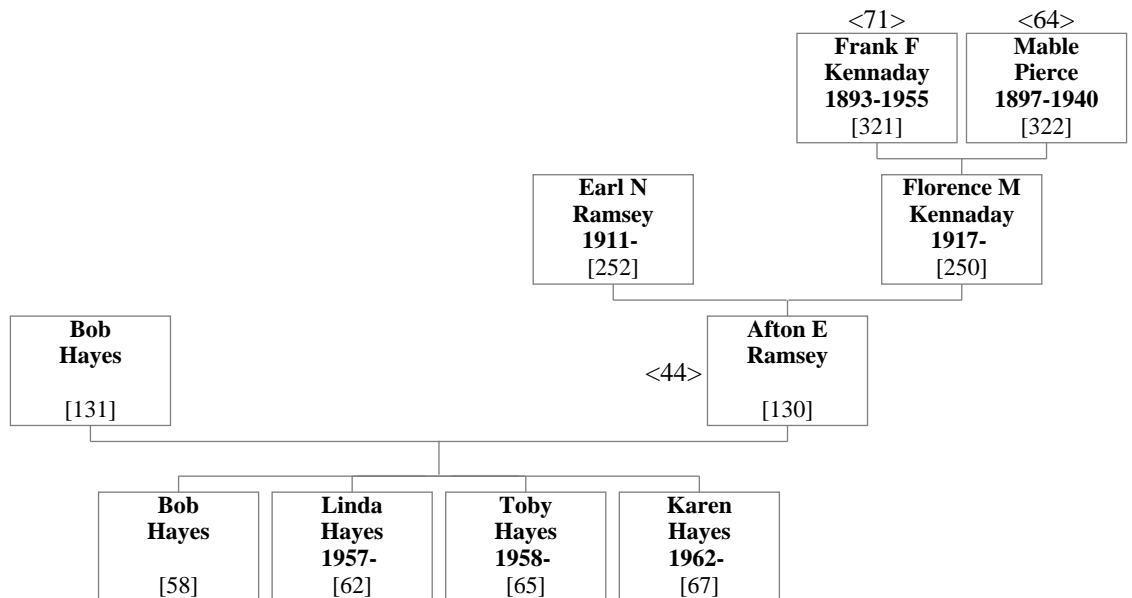

13. Jack Wayne Kennaday & Carol Lee Brant

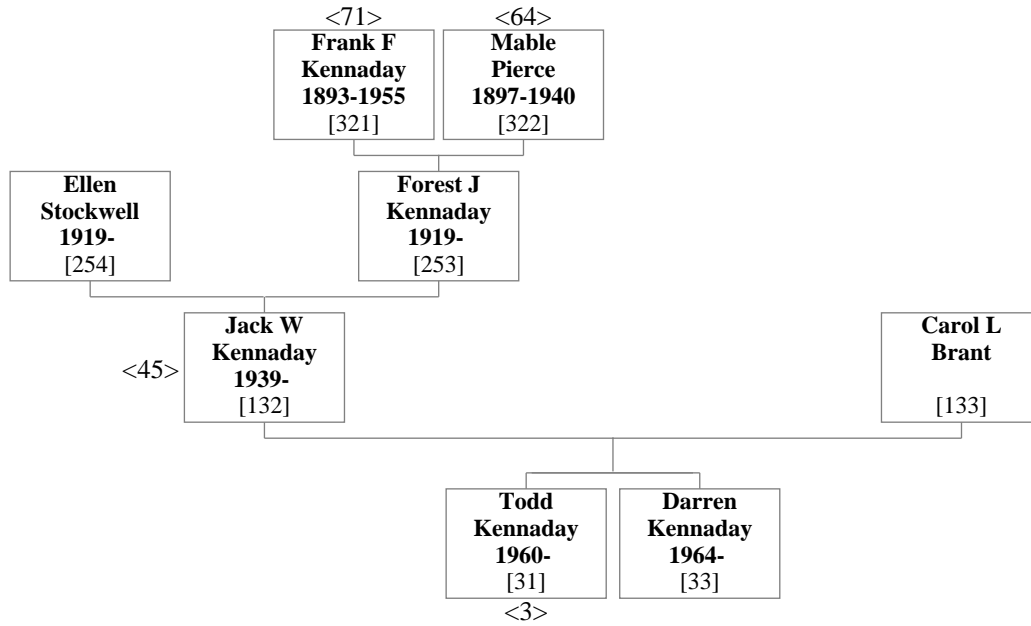

14. Gary Forrest Kennaday & Alice Thompson

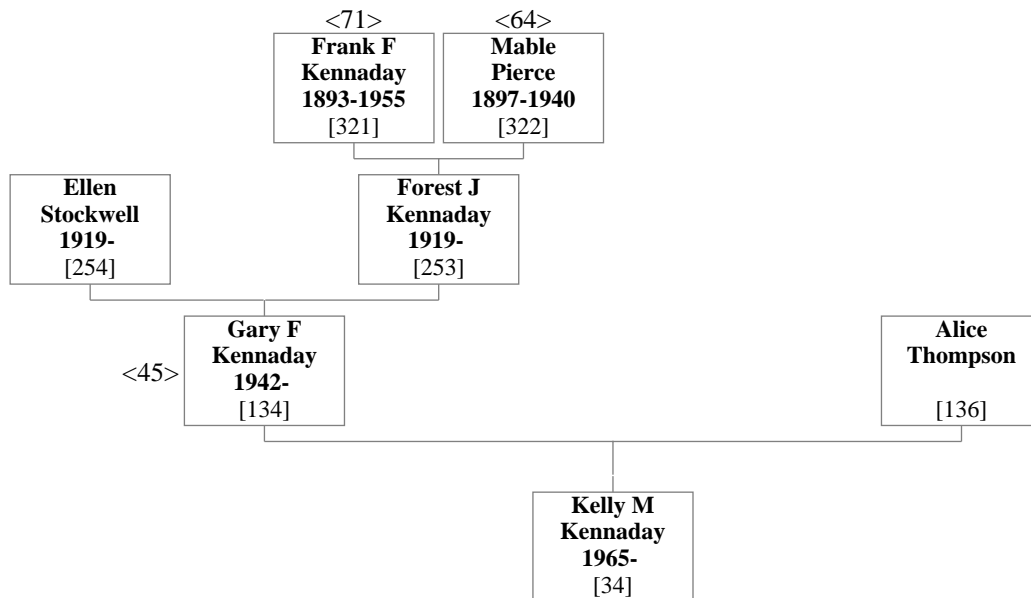

15. Michael Joseph Kennaday & Carolyn Williams

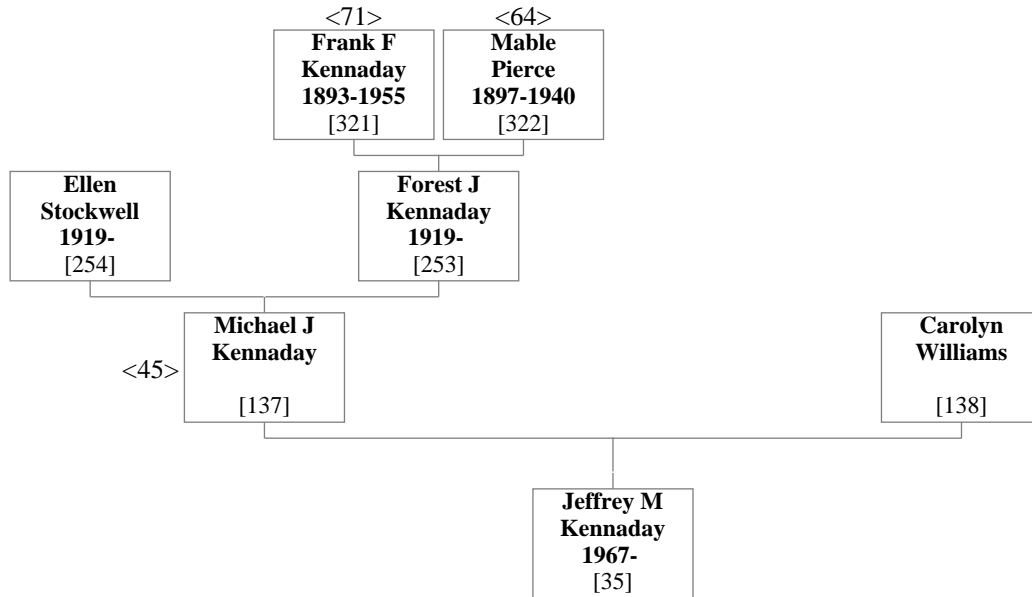

16. Jimmy Ray Lott & Ellen Dollar Hyde

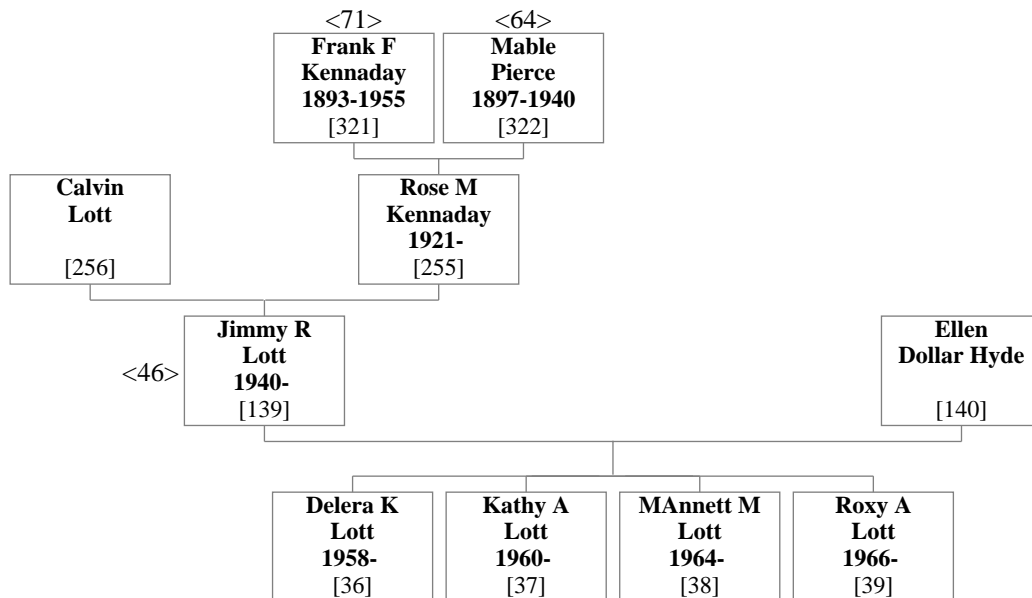

17. Al Blunt & Rosa Lee Lott

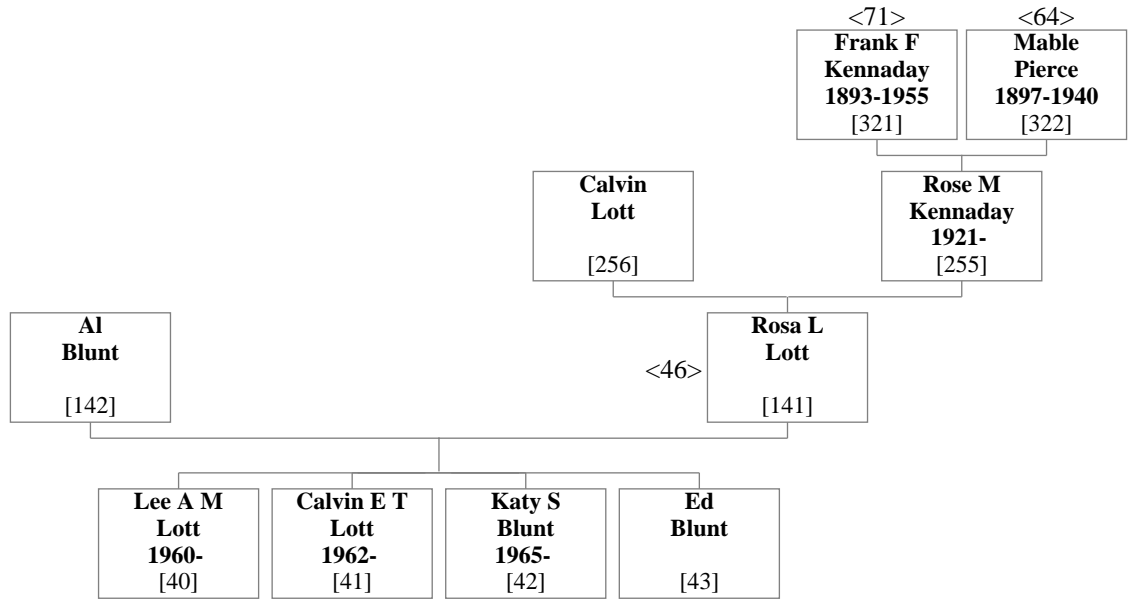

18. Calvin Jay Lott & Jo Ann Sturgess

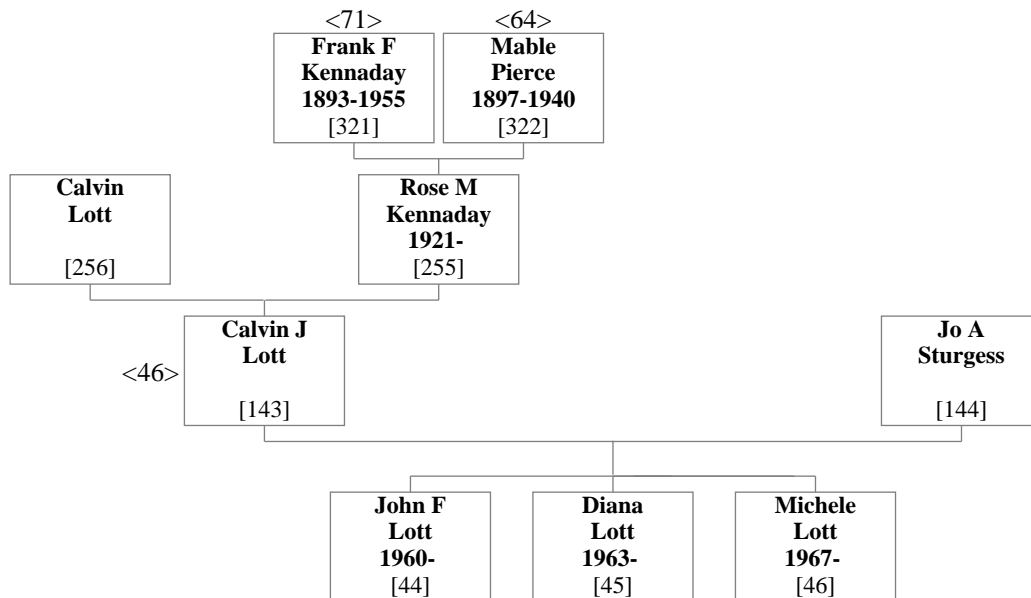

19. Mr. Sloane & Mable Bea Lott

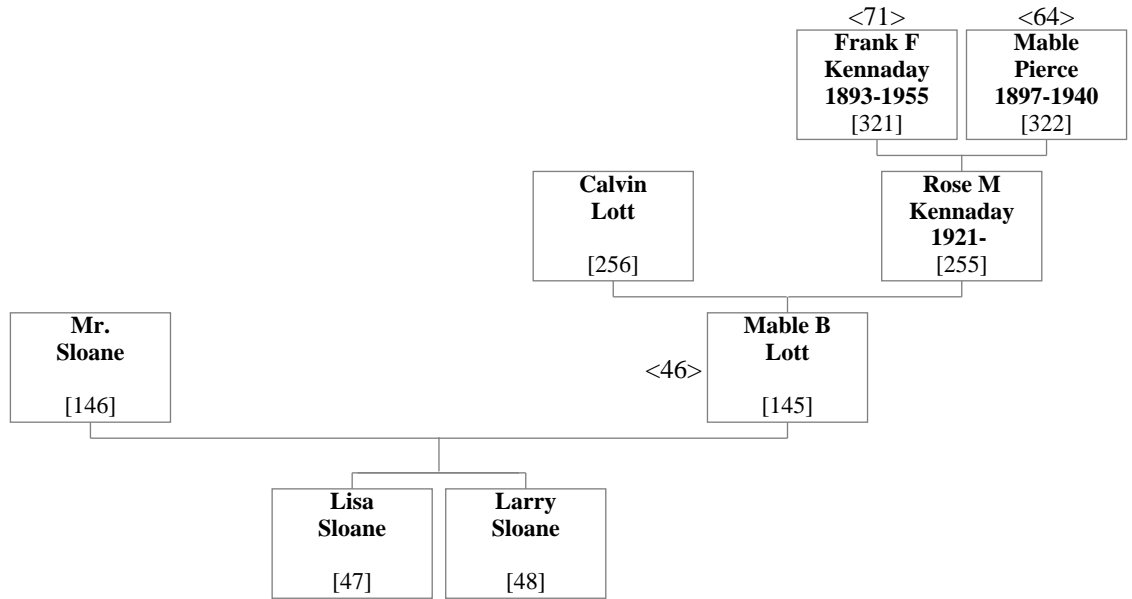

20. Ronald David Kelley, Sr. & Betty Carol Fitzpatrick

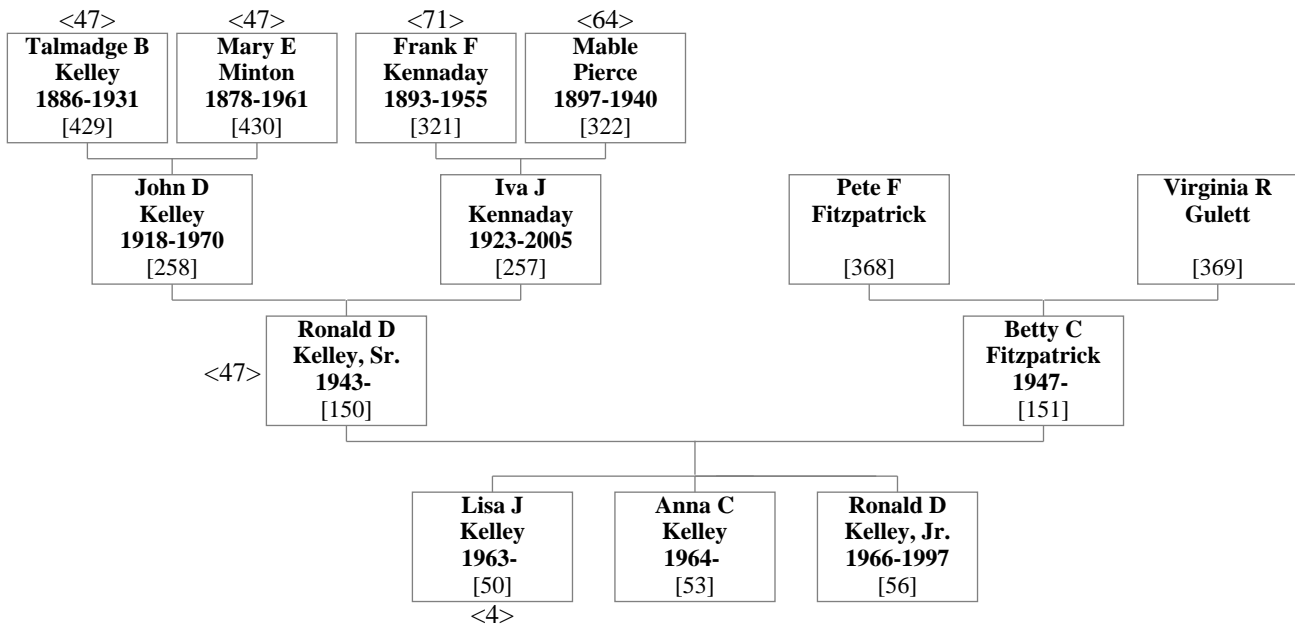

21. Norman Perry Curtis & Carolyn June Kelley

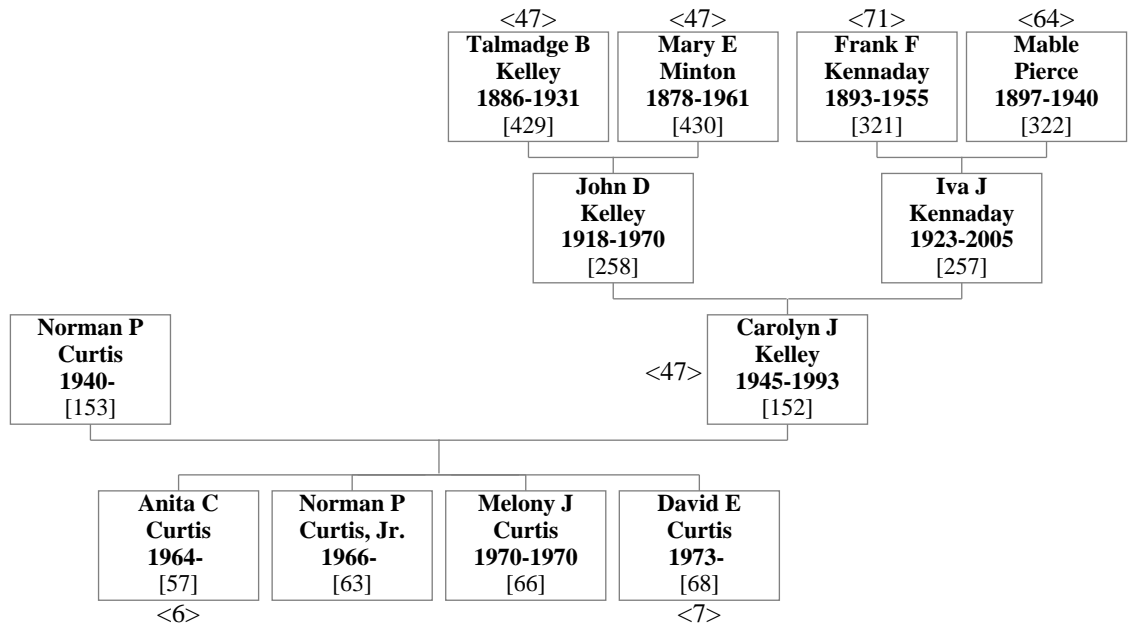

22. Gordon Johnson & Sherry Jean Marier

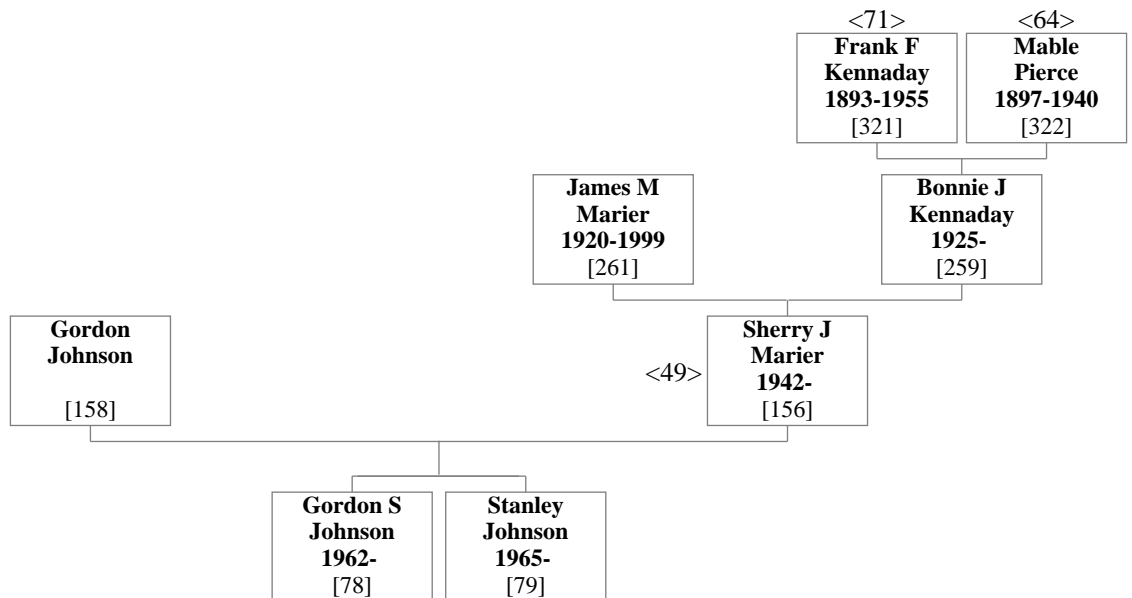

23. Micheal A Forrester & Jane Marie Marier

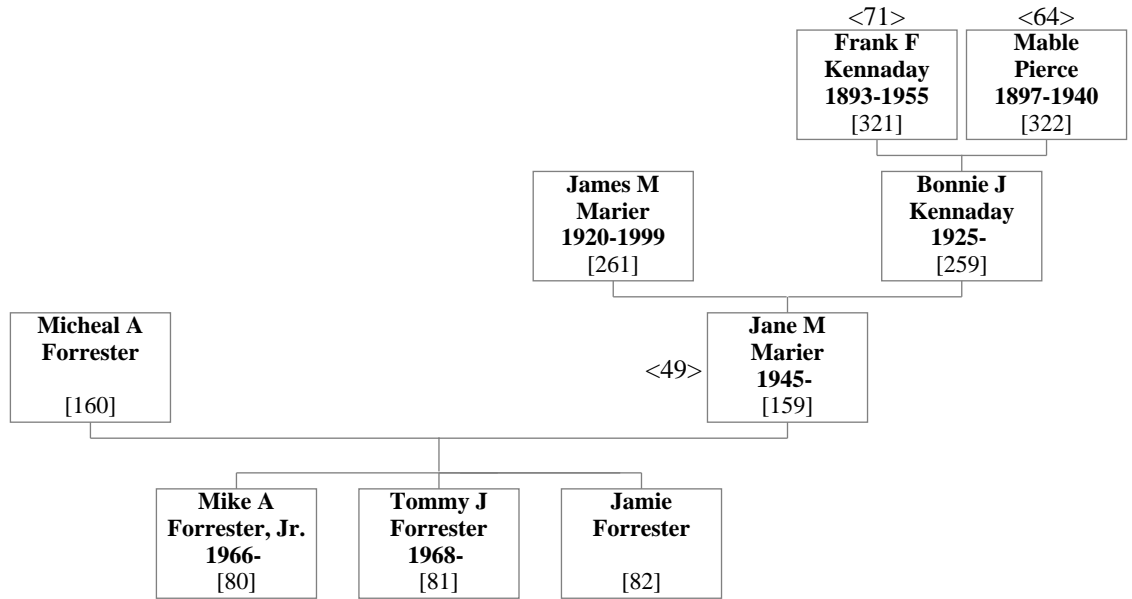

24. David Debernardi Kennaday & Paula Jo Smith

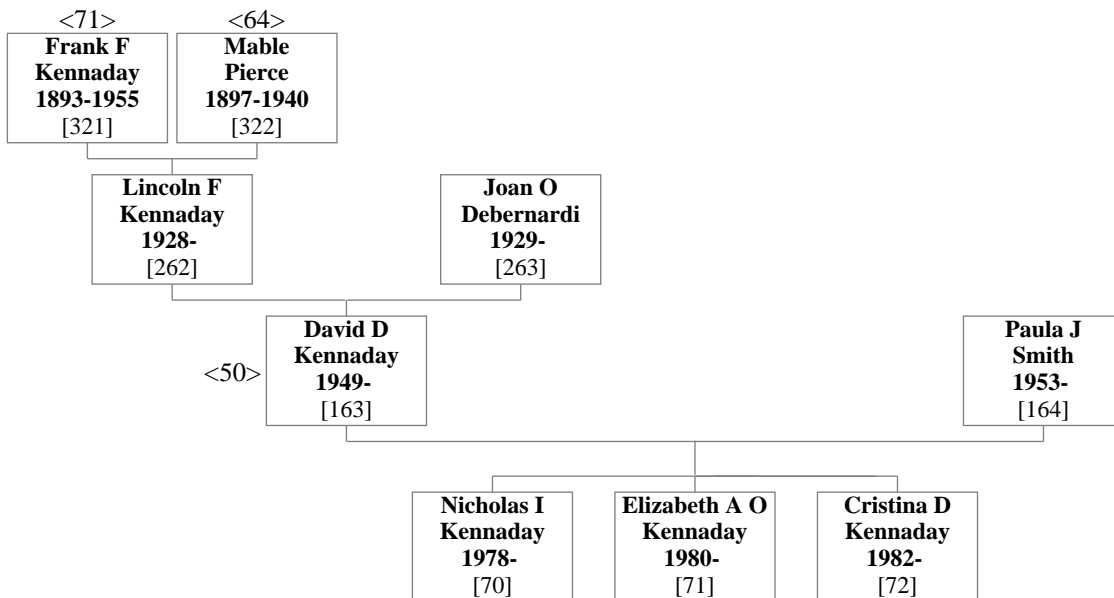

25. Steven Scott Kennaday & Catherine Susan Lavelle

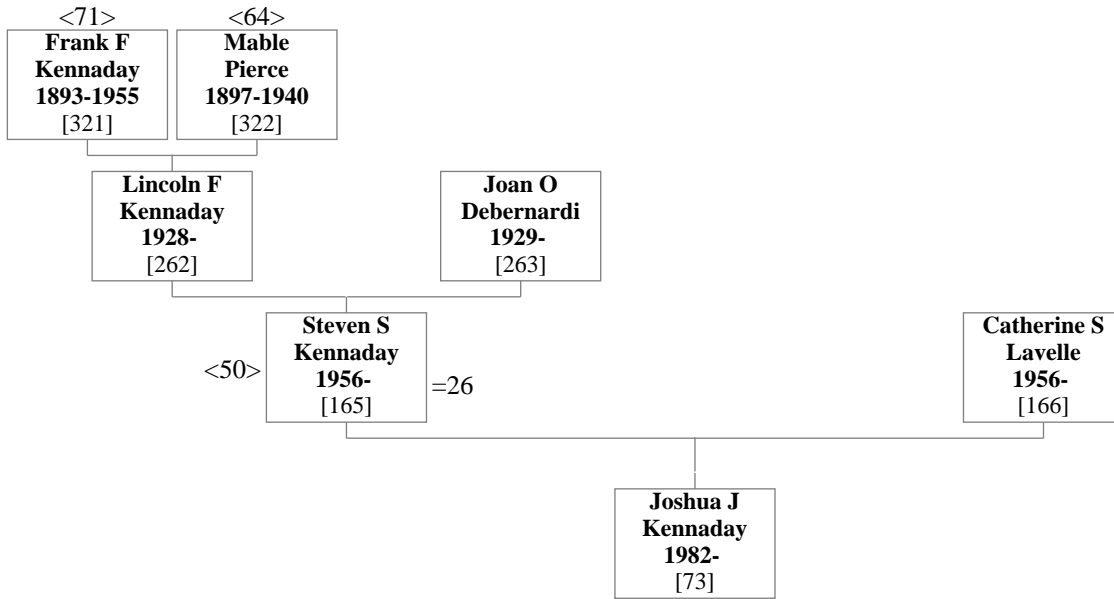

26. Steven Scott Kennaday & Danielle Reed

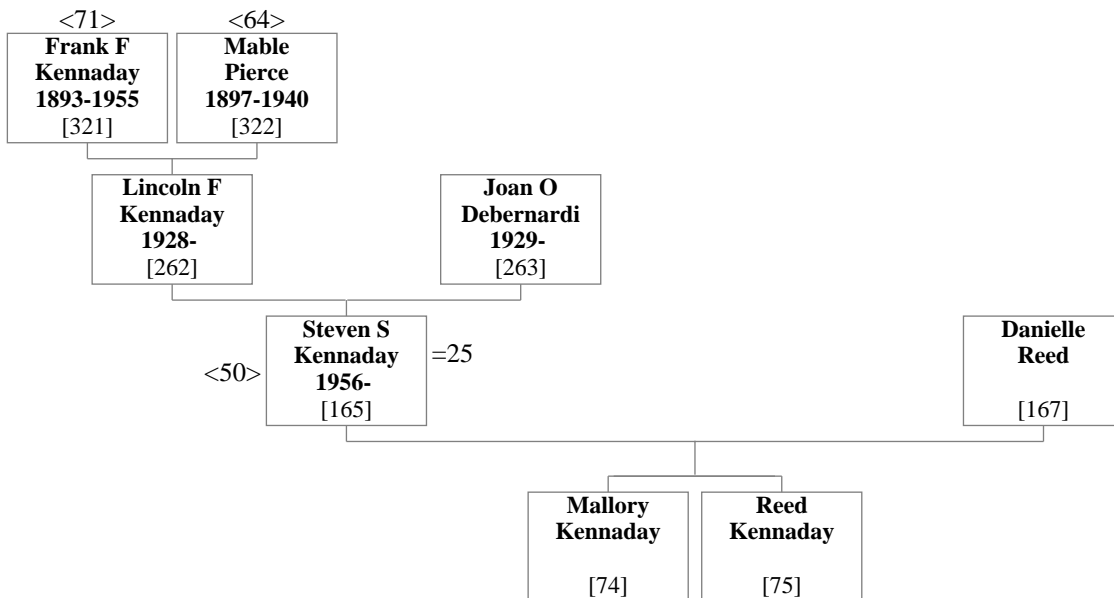

27. Fredrick Frank Kennaday & Brigid Ann Young

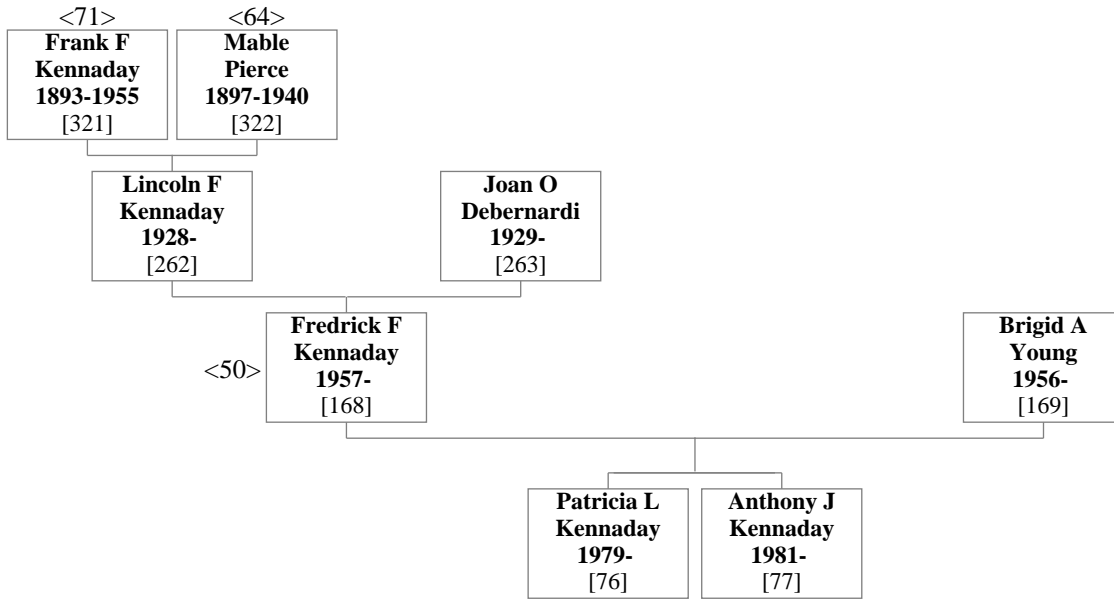

28. Nelson Chester Whitman & Cecelia Kay Pendergrass

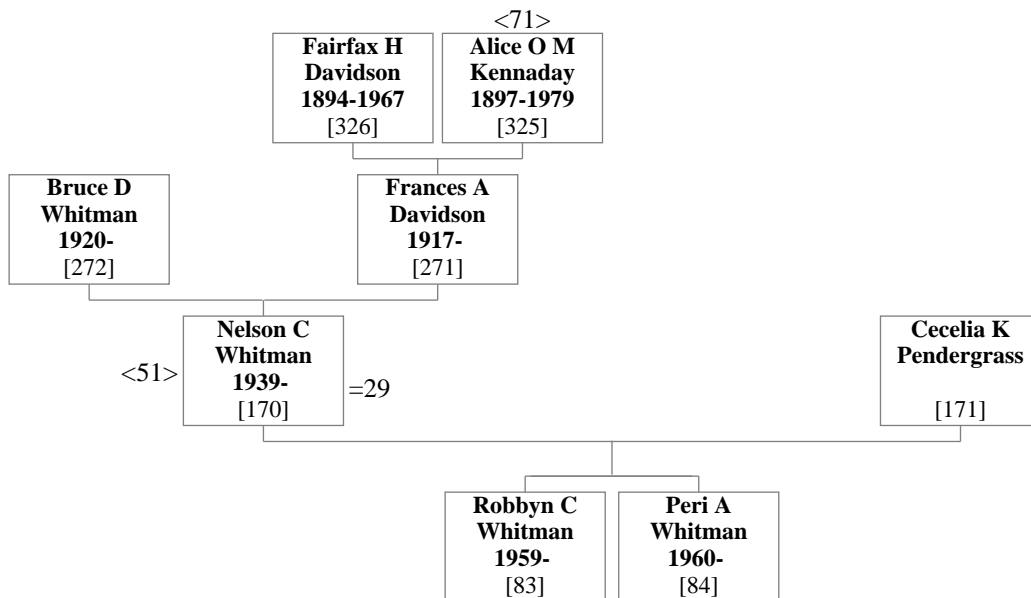

29. Nelson Chester Whitman & Claudette Irene Corlett

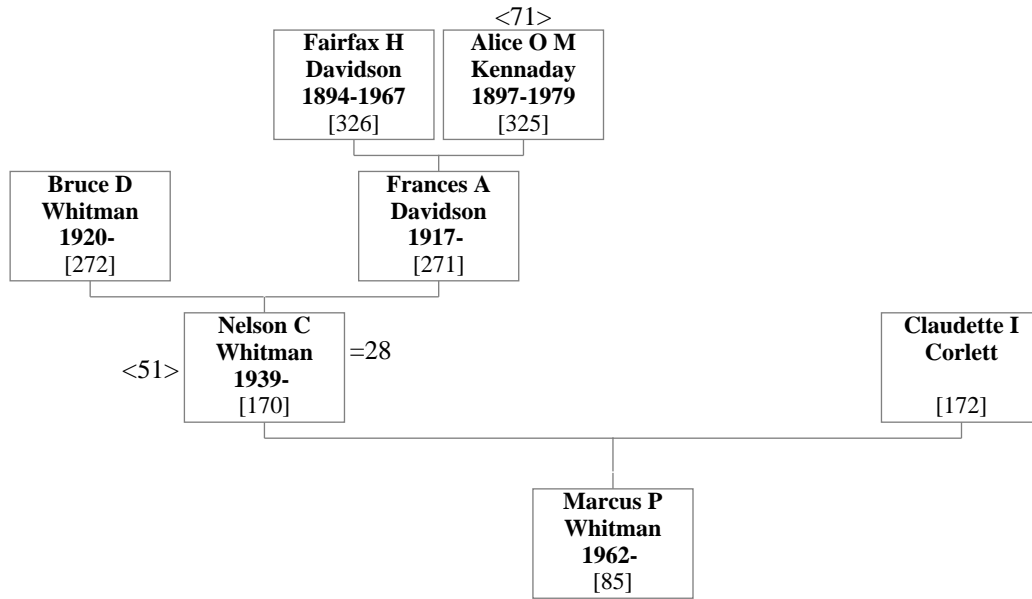

30. Boyd David Whitman & Carolyn M Thompson

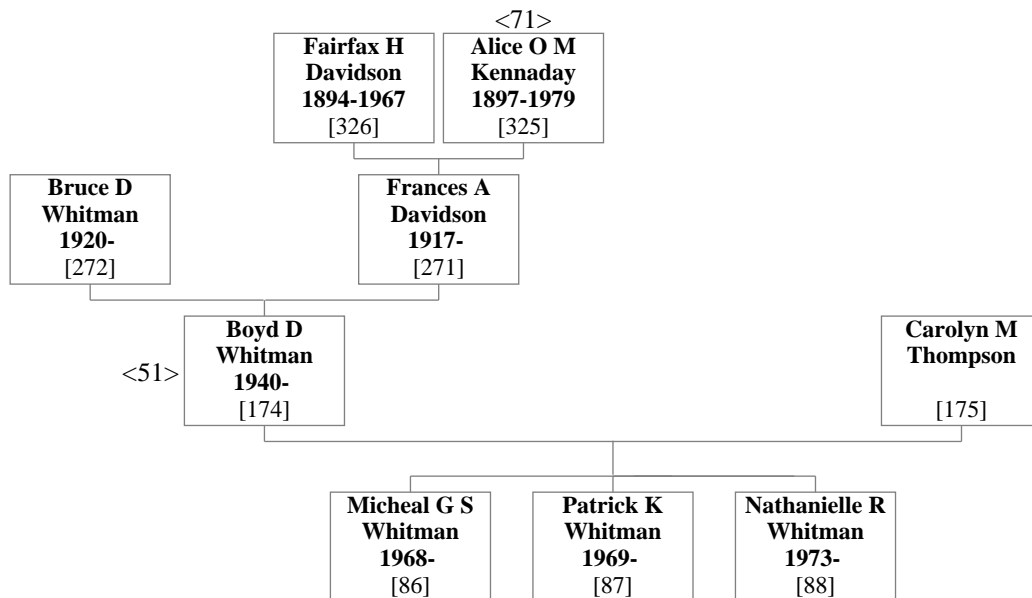

31. Richard Ward Whitman & Robin Knipp Jouett

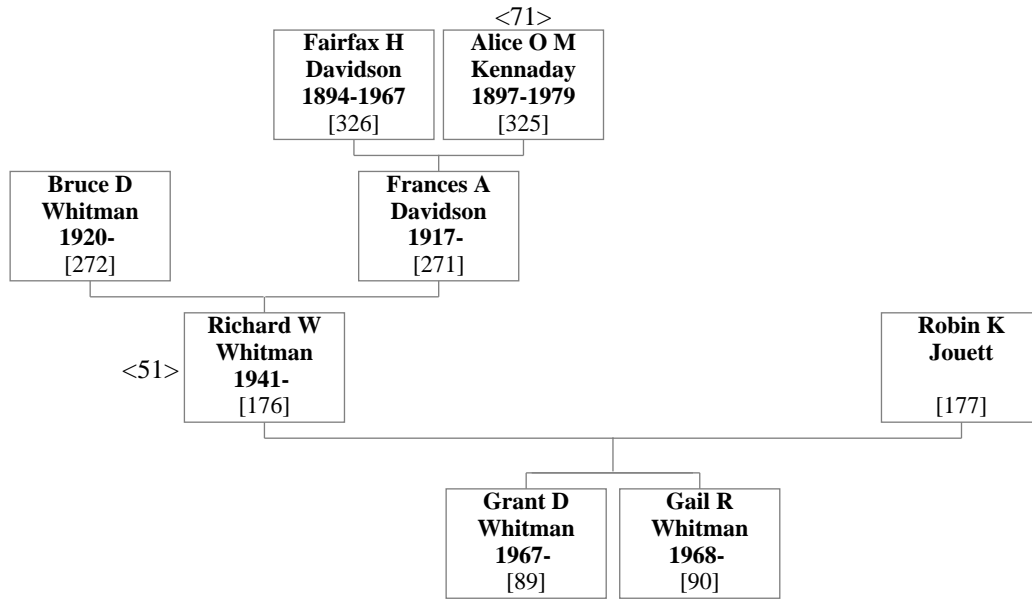

32. Joseph Grant Bartlett & Charlotte Louise Whitman

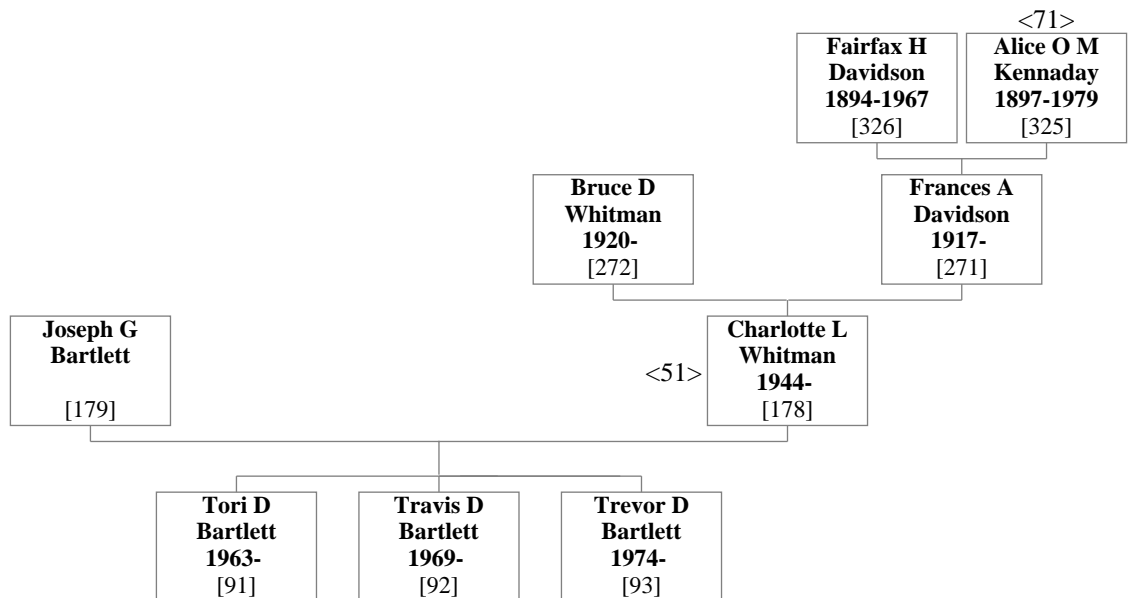

33. Tommy M Thompson & Marcella Ann Whitman

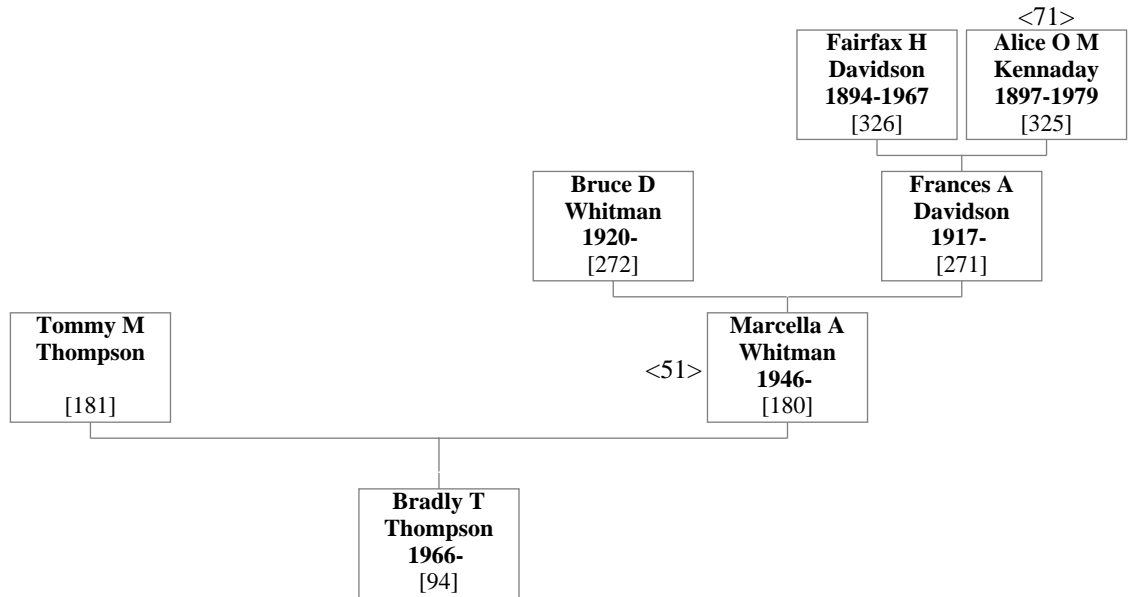

34. Fred Winton Smith & Phillis Lana Whitman

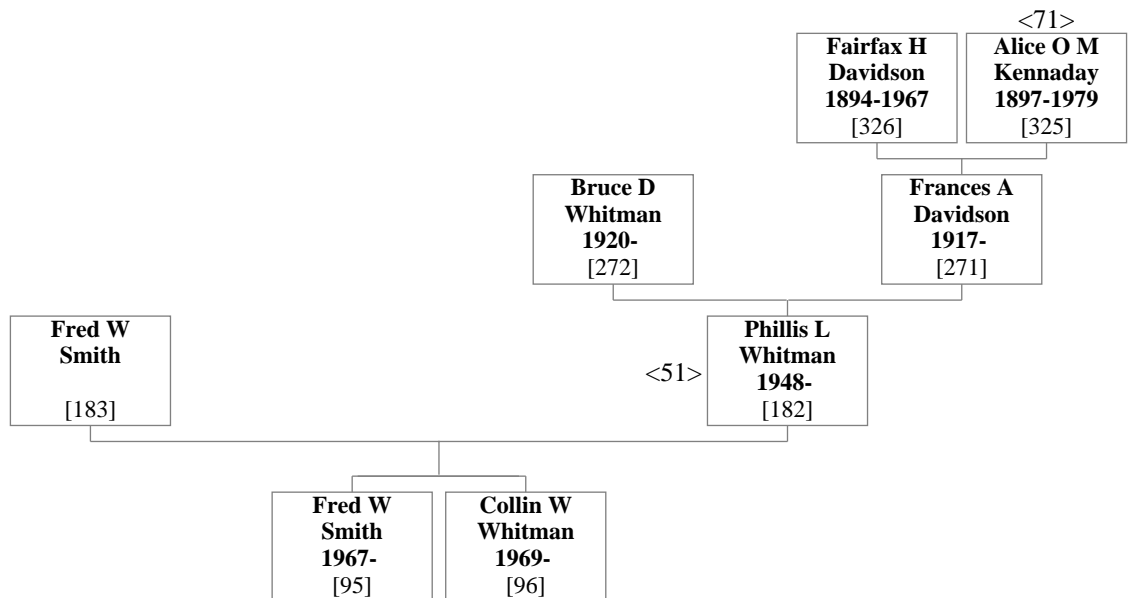

35. Stanley Howard Self & Laurel Alice Whitman

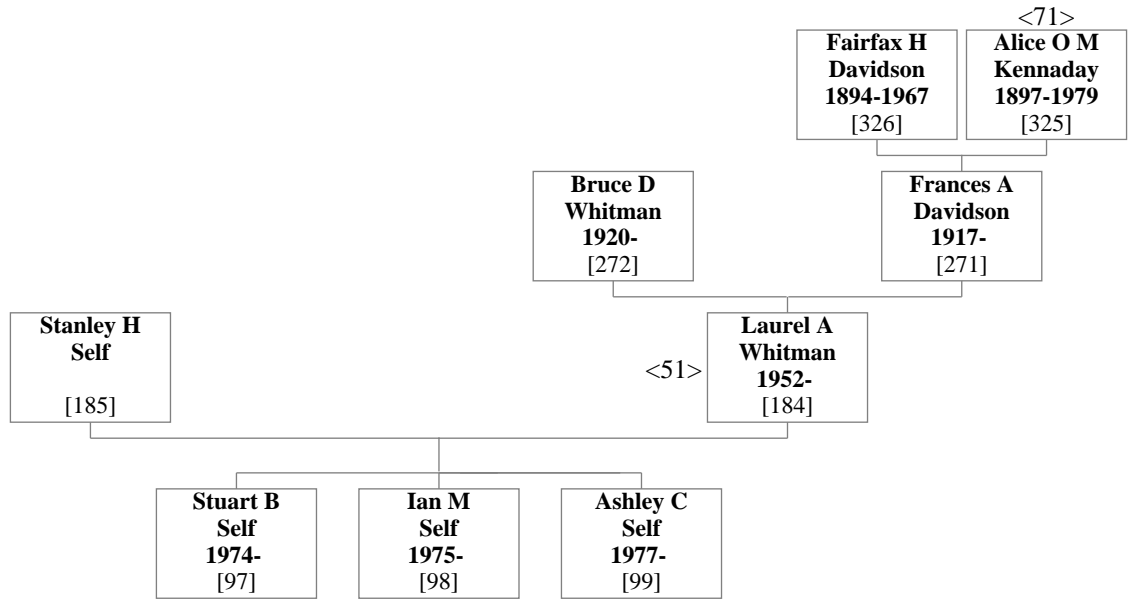

36. Ronald Otis Page & Linda Ann Cairns

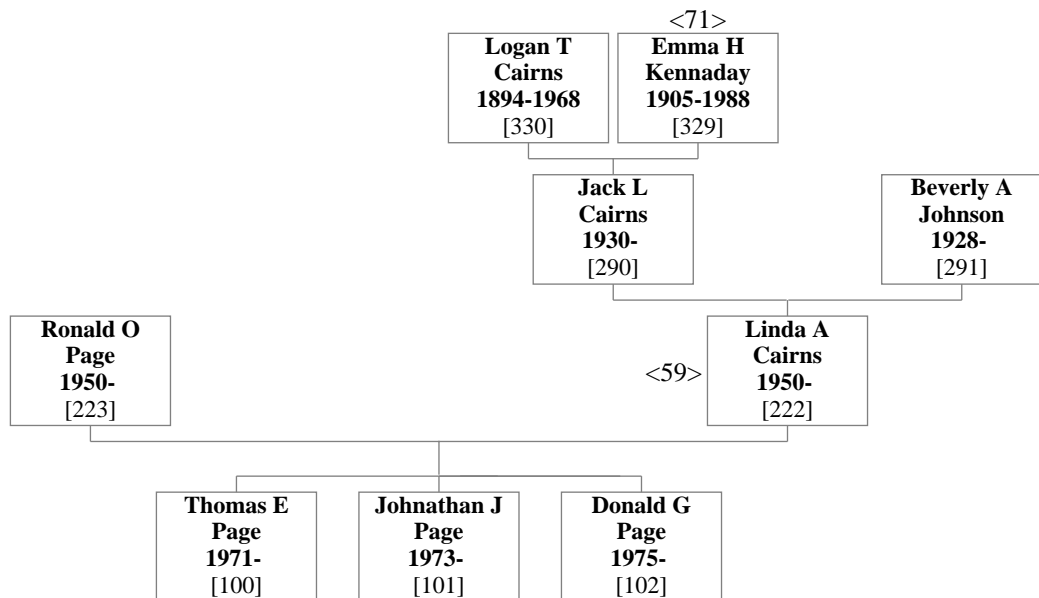

37. Craig Campbell & Christine Marie Cairns

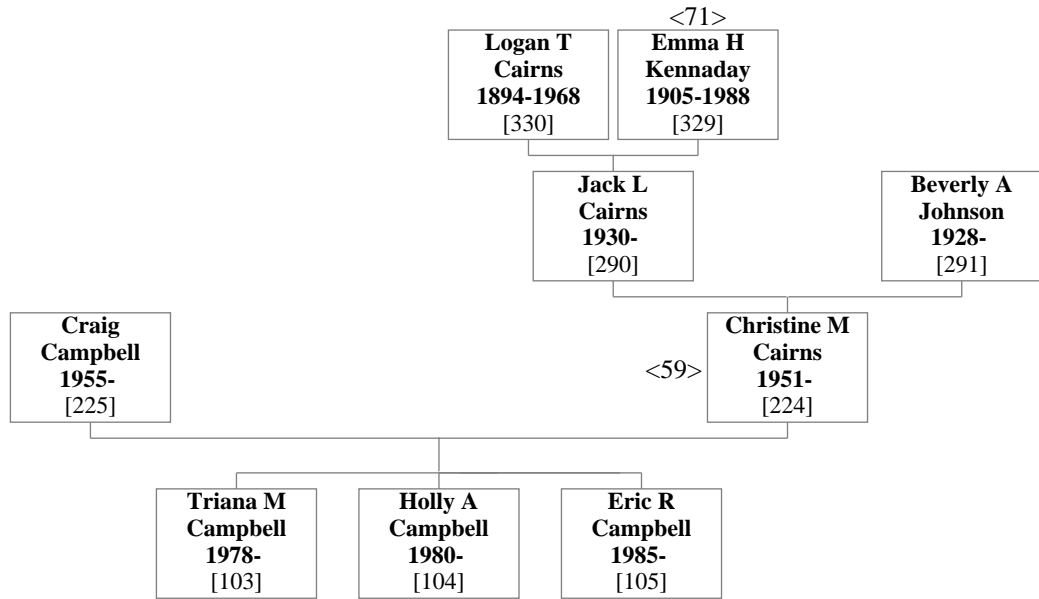

38. Jack Lavoy Cairns, Jr. & Rebecca Cassler

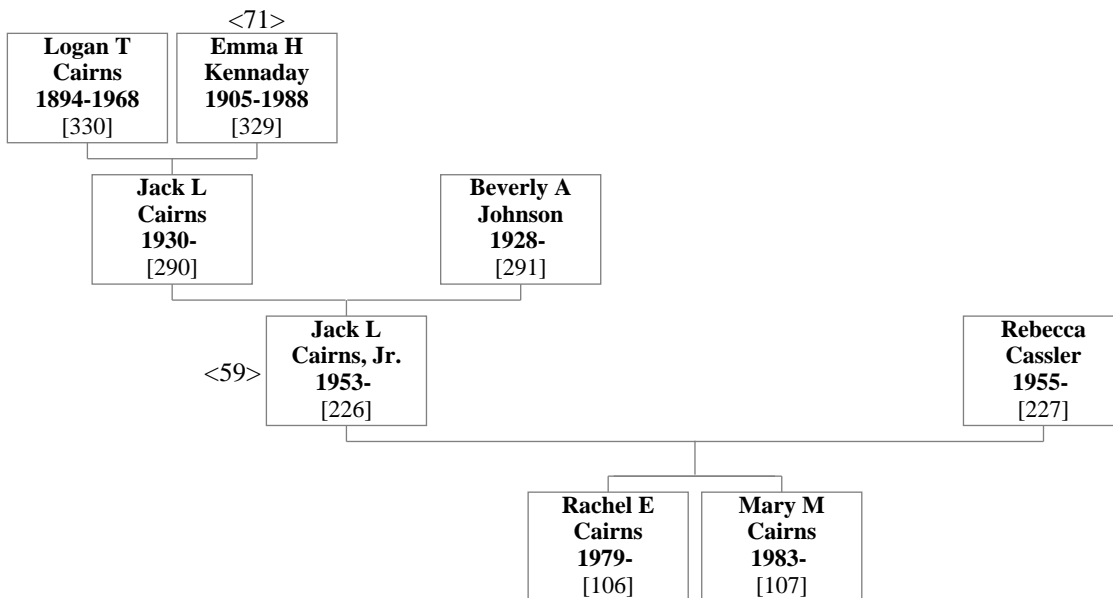

39. Alan Hansen & Elizabeth Kay Cairns

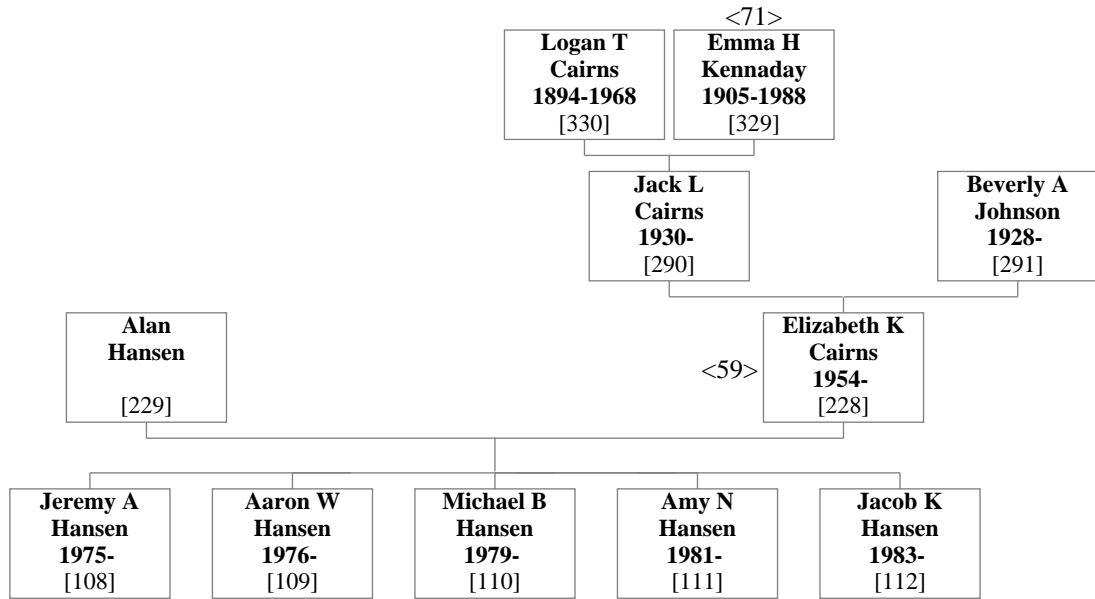

40. William Wayne Cairns & Kae Porter

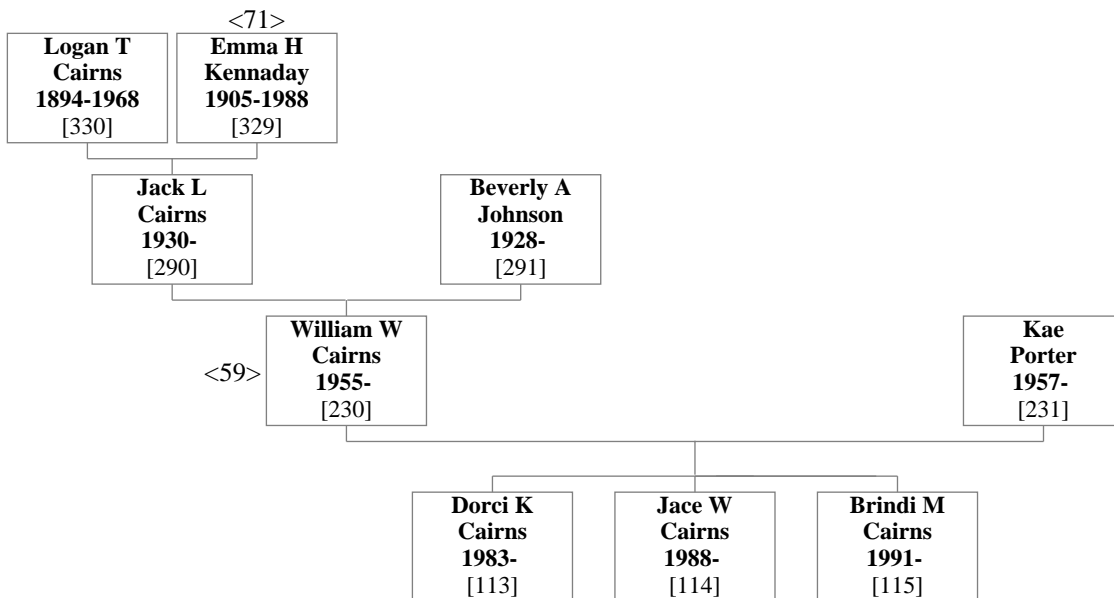

41. John Ellery Cooper & Rebecca Gay Cairns

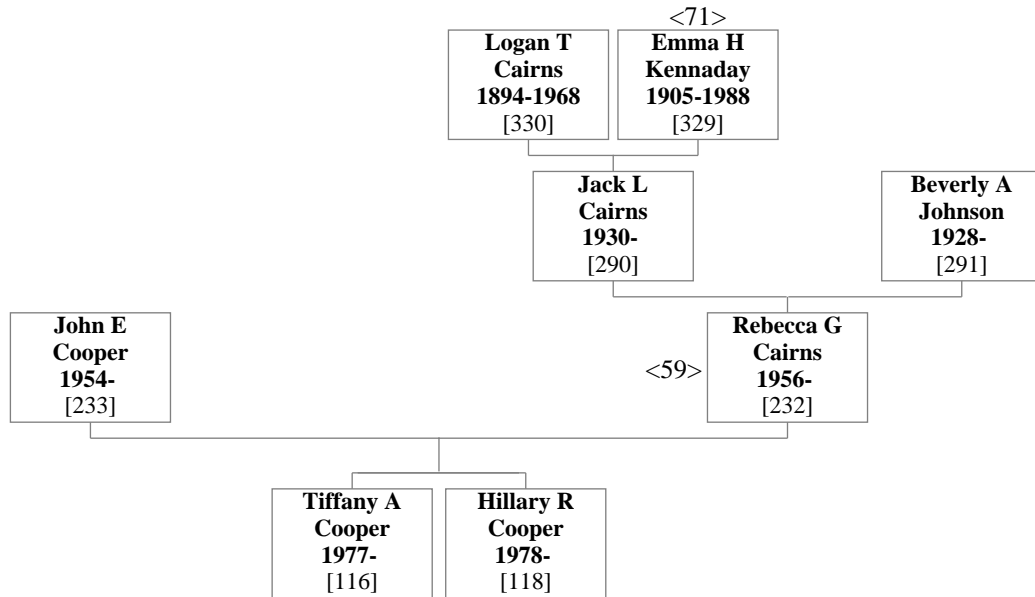

42. Carlie Jebens & Phyllis Ann Wilson

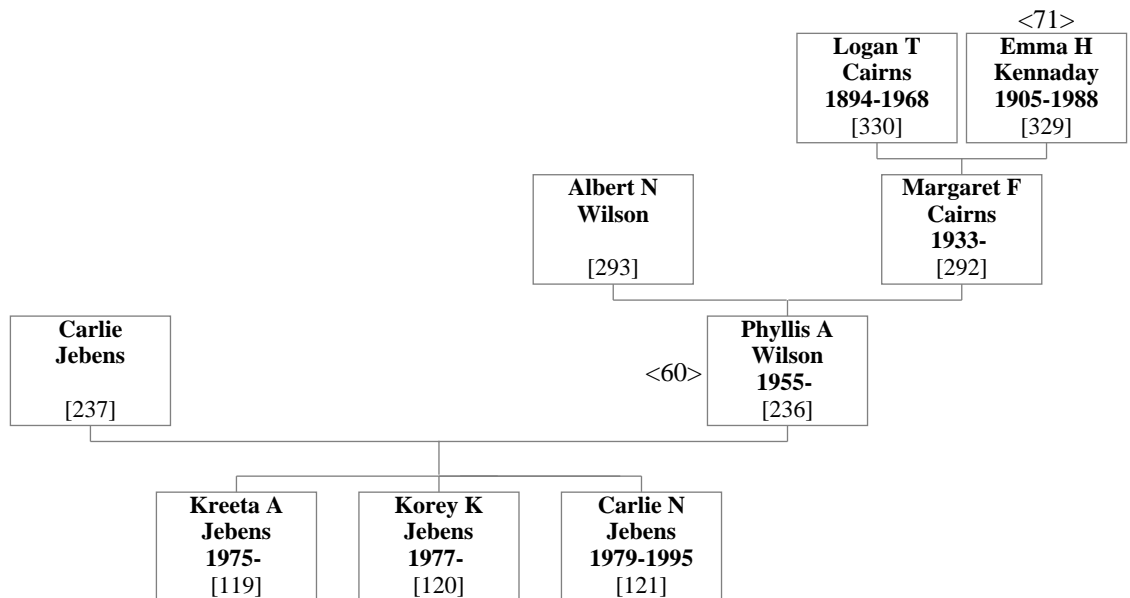

43. Thomas Earl Kennaday & Gladys Eleanor Ream

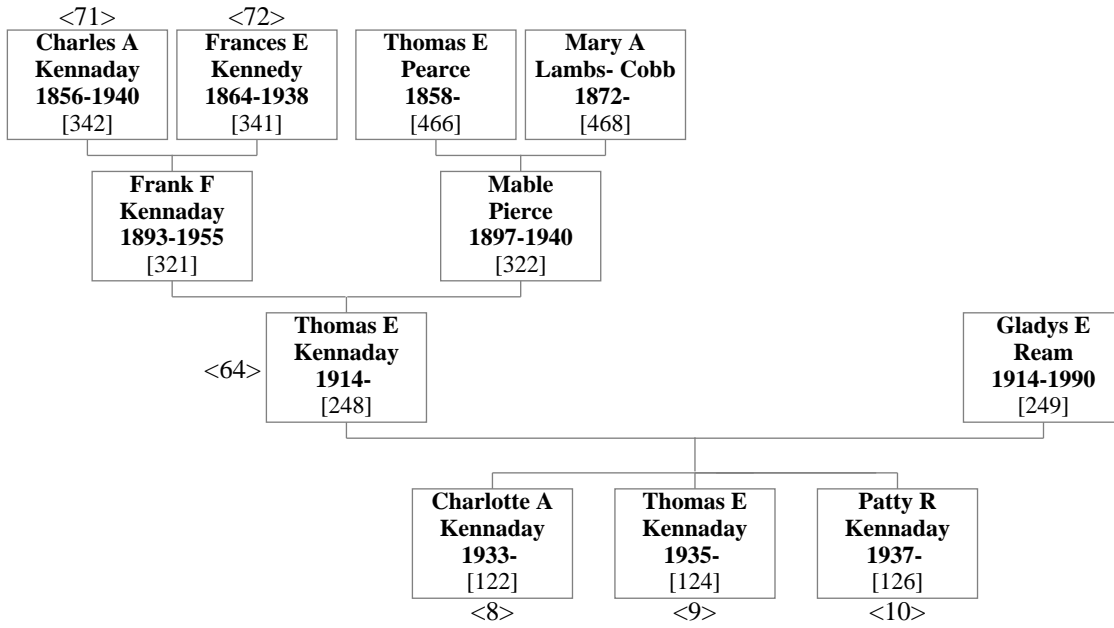

44. Earl N Ramsey & Florence Mae Kennaday

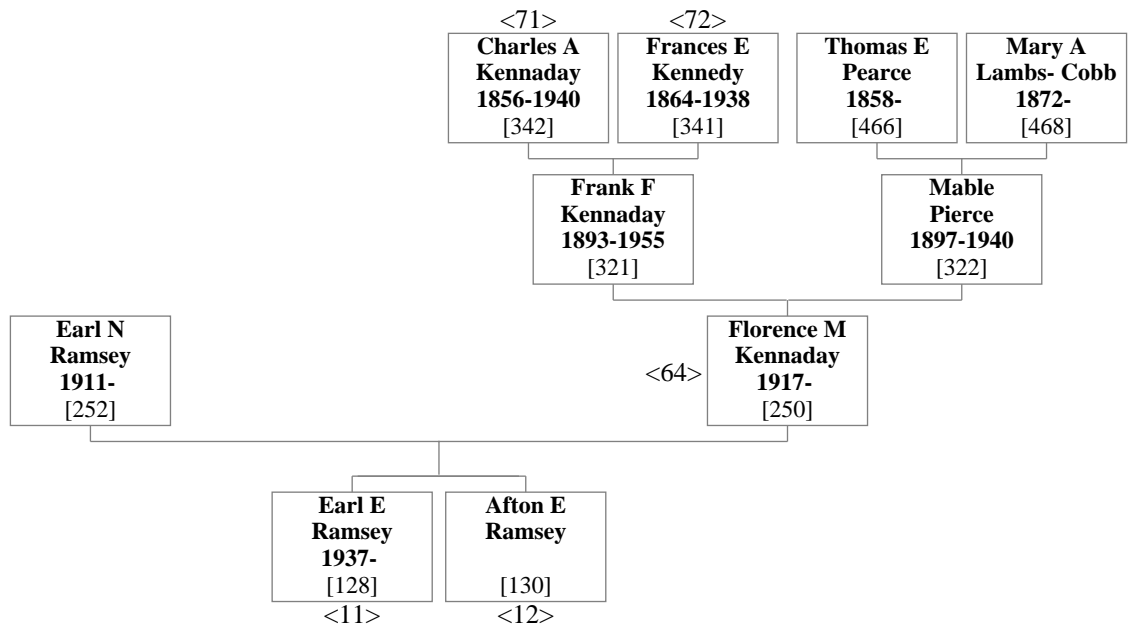

45. Ellen (Dude) Stockwell & Forest Jack Kennaday

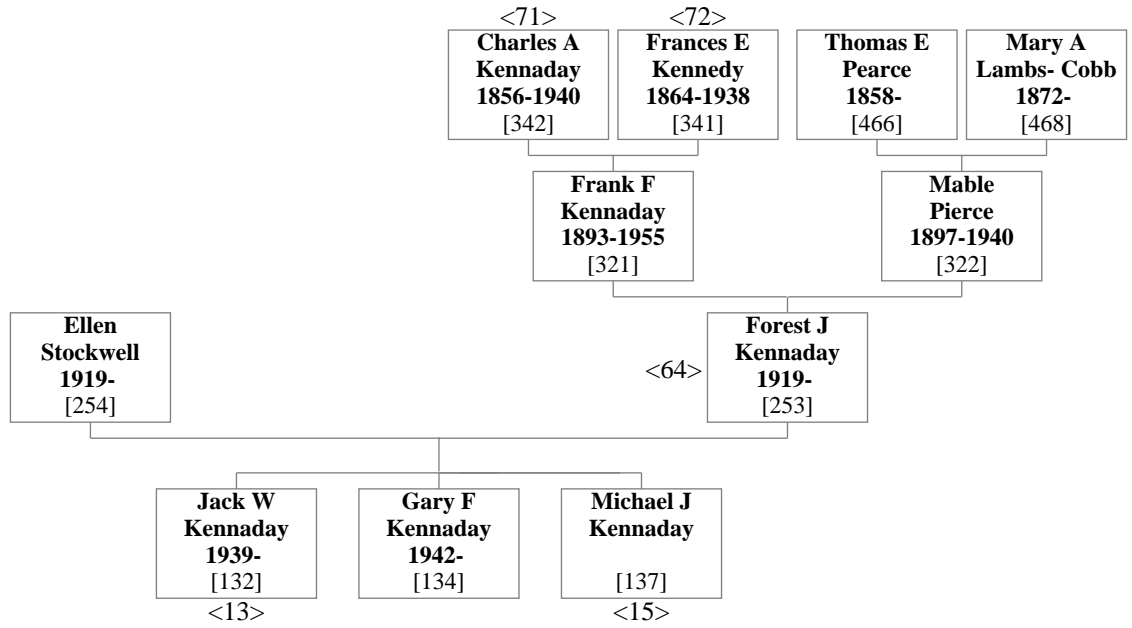

46. Calvin Lott & Rose Marie Kennaday

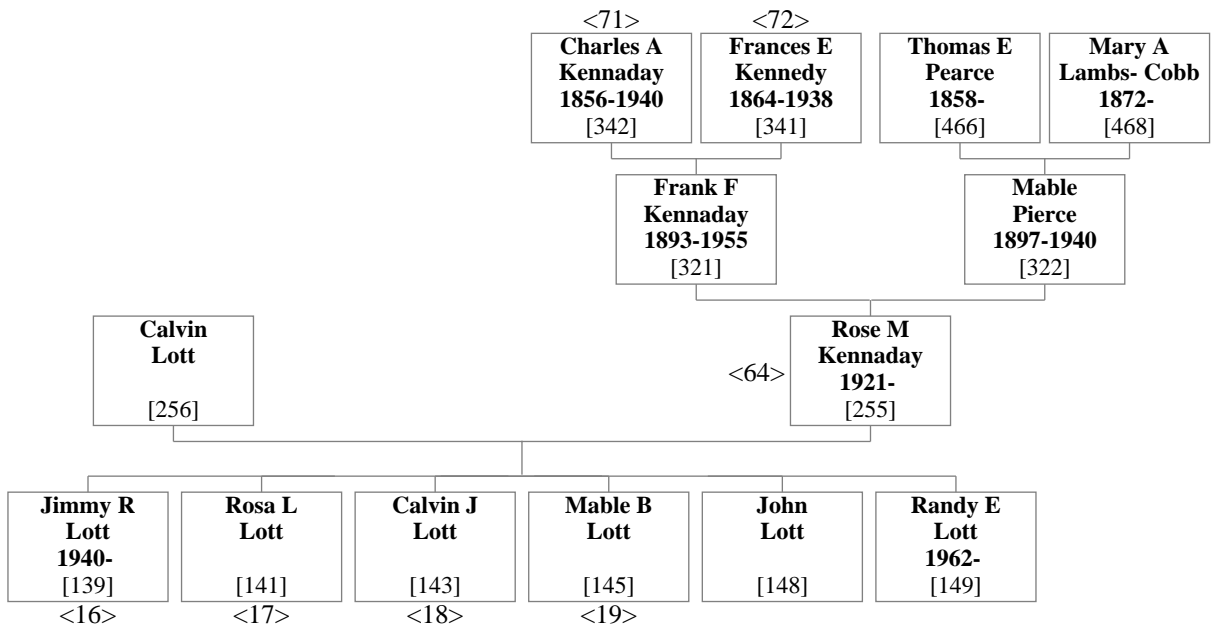

47. John David Kelley & Iva June Kennaday

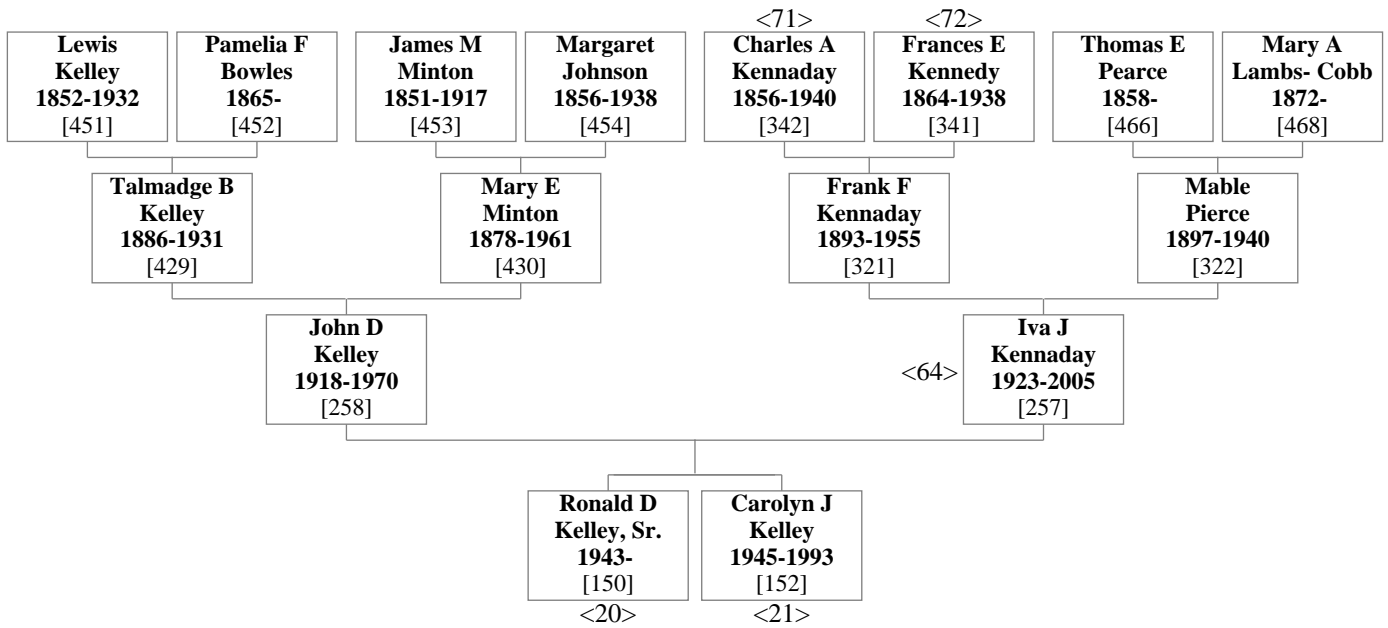

48. Gordon Johnson & Bonnie Jean Kennaday

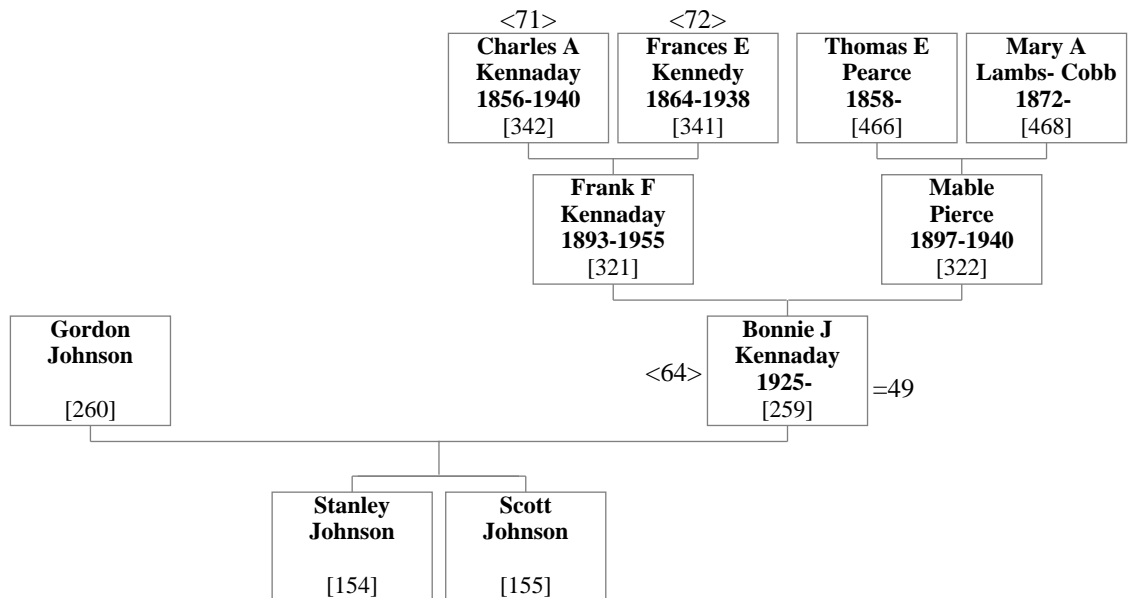

49. James Martin Marier & Bonnie Jean Kennaday

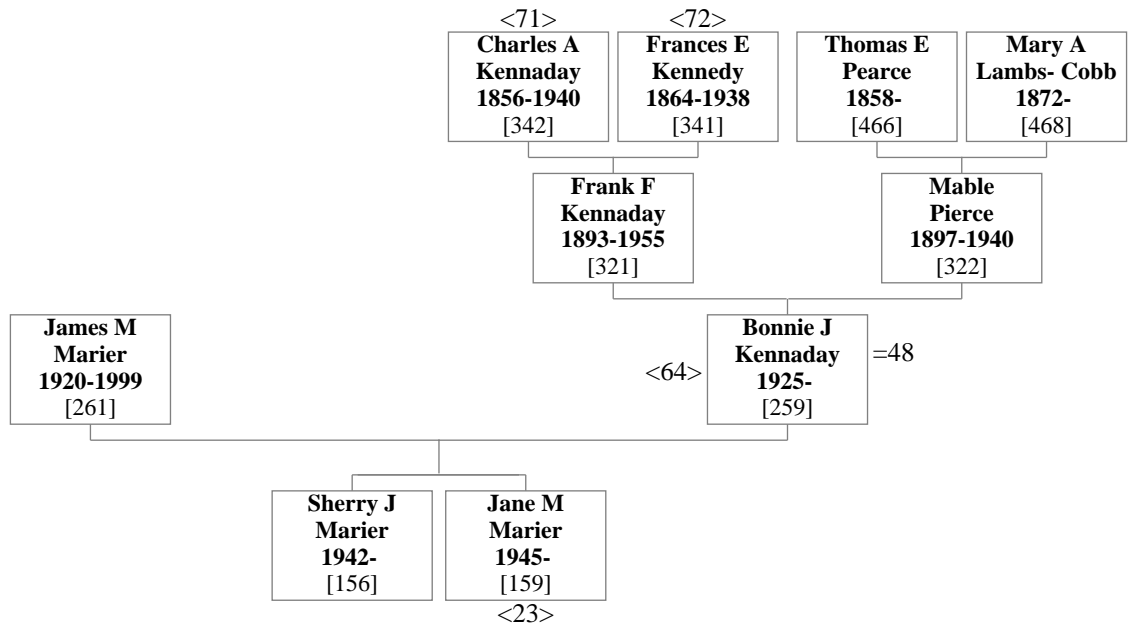

50. Lincoln Frank Kennaday & Joan Olivia Debernardi

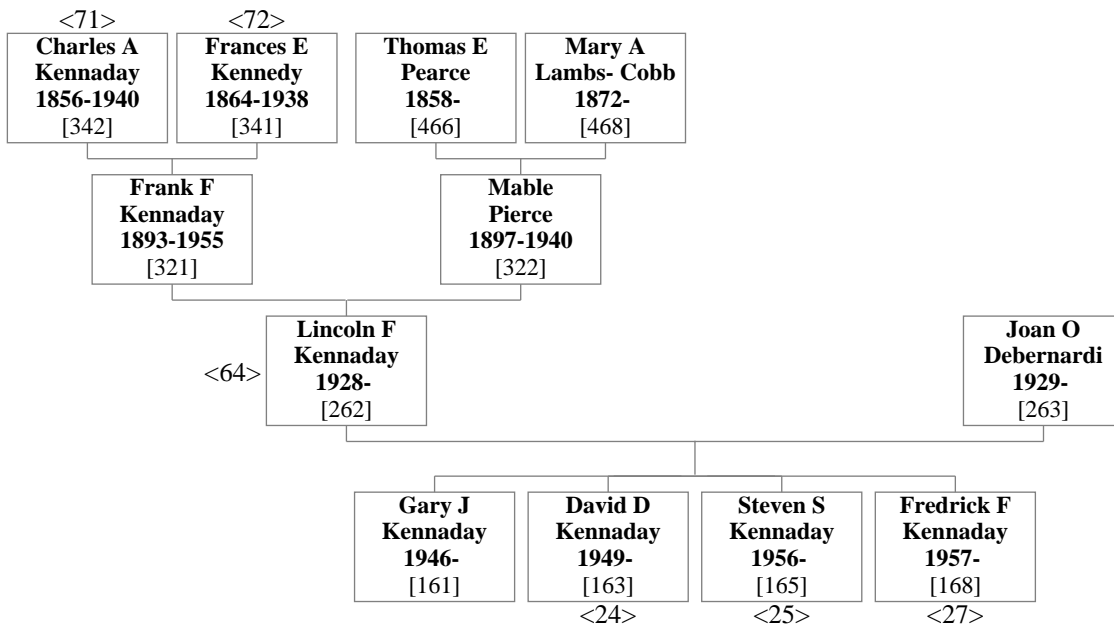

51. Bruce Douglas Whitman & Frances Amonda Davidson

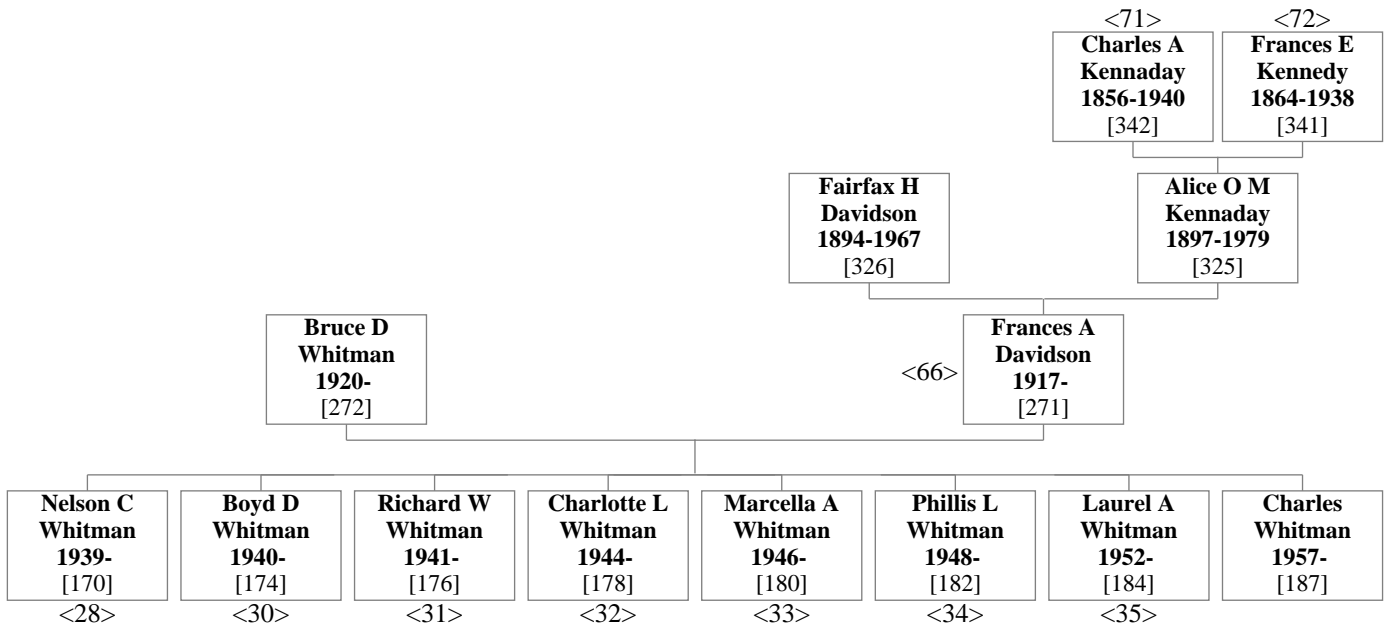

52. Robert Orrin Rogerson & Vita Maude Davidson

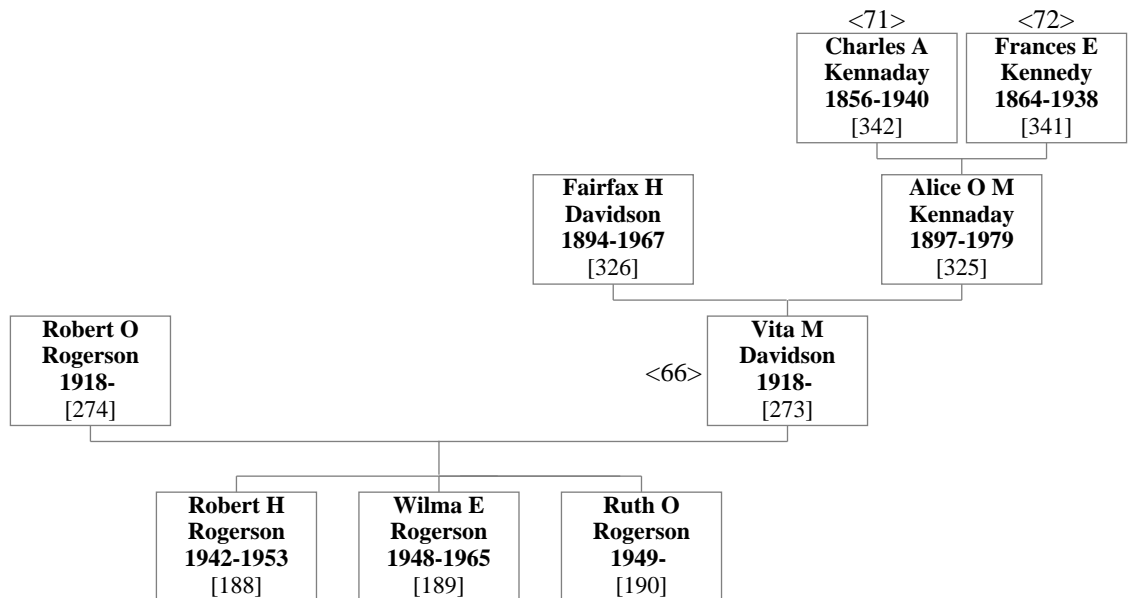

53. Harvey Alton Blackburn & Louize Gertrude Davidson

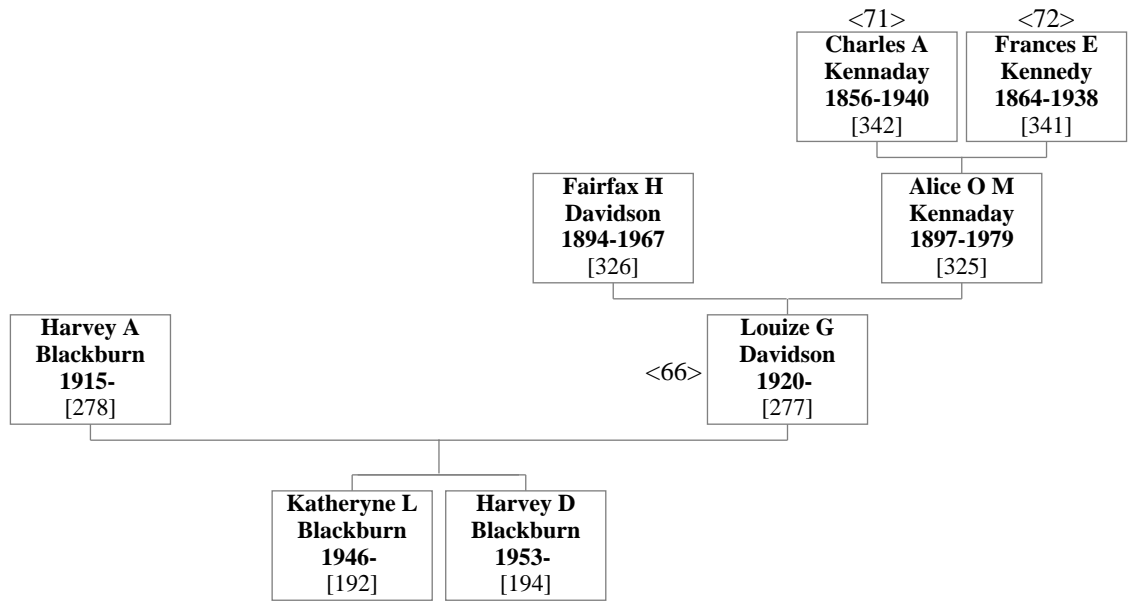

54. Chester Clark Davidson & Norma Hilda Dadisman

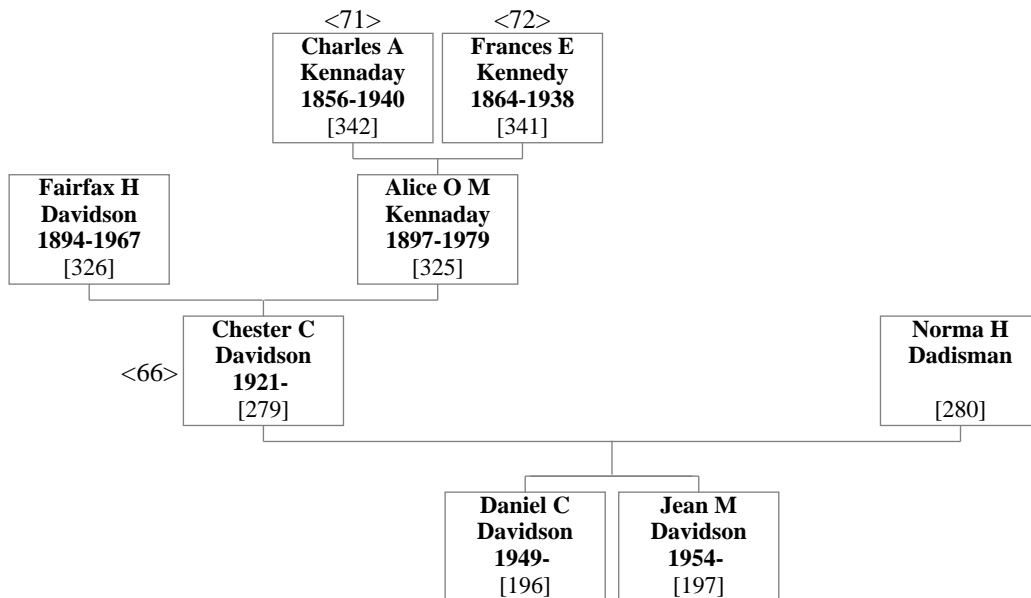

55. Walter Cecil Ackerson & Eleanora Alice Davidson

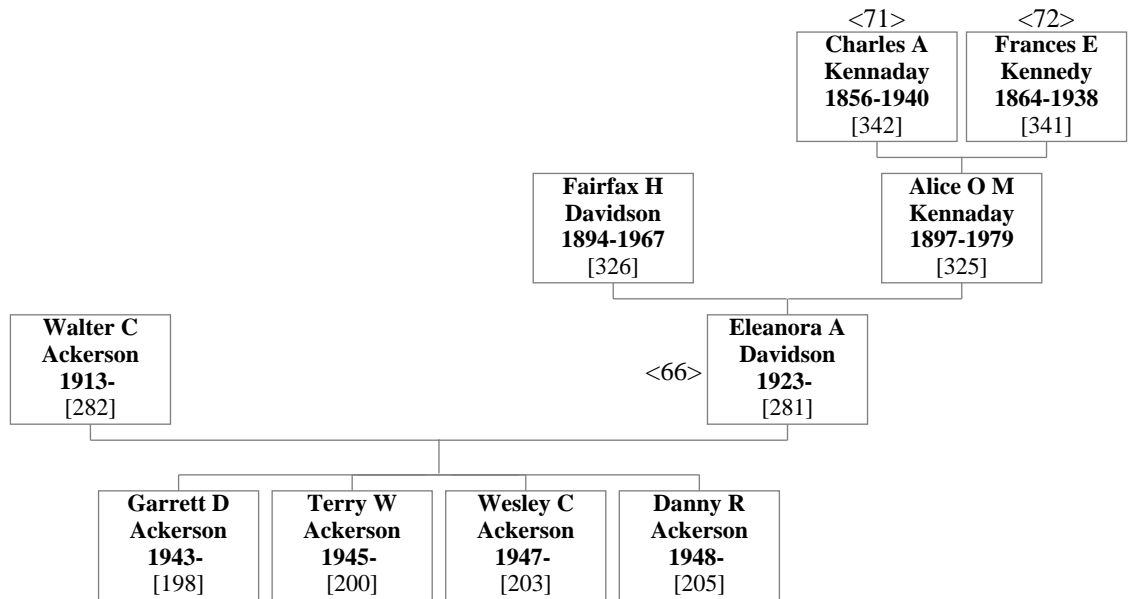

56. Charles Daniel Davidson & Earlene Dee Noller

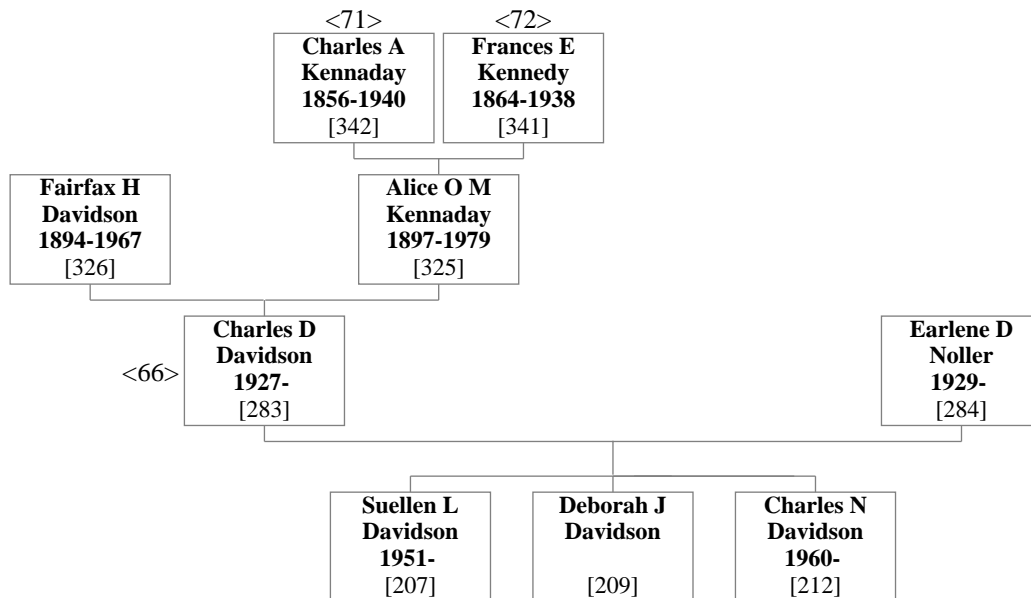

57. David Debernardi Harned & Myrtle Rae Davidson

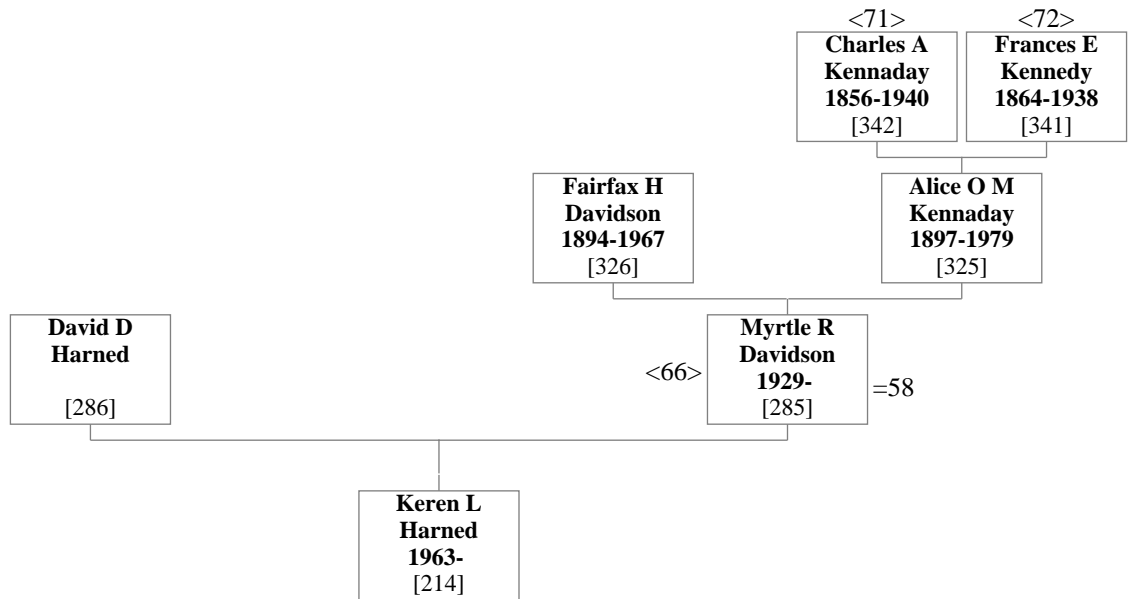

58. Ronald Clark Redman & Myrtle Rae Davidson

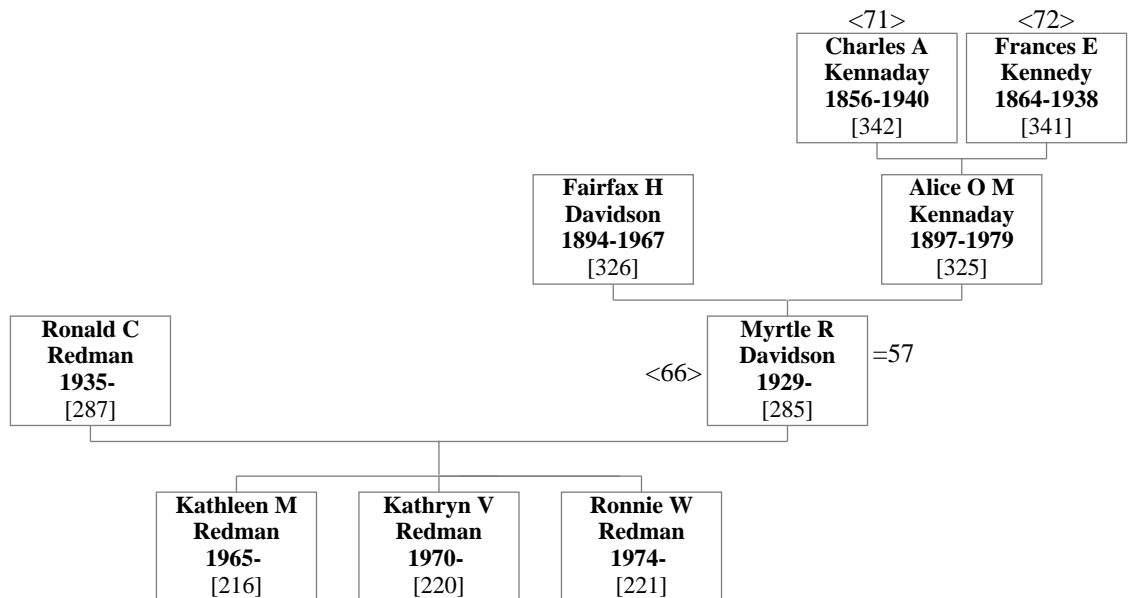

59. Jack Lavoy Cairns & Beverly Ann Johnson

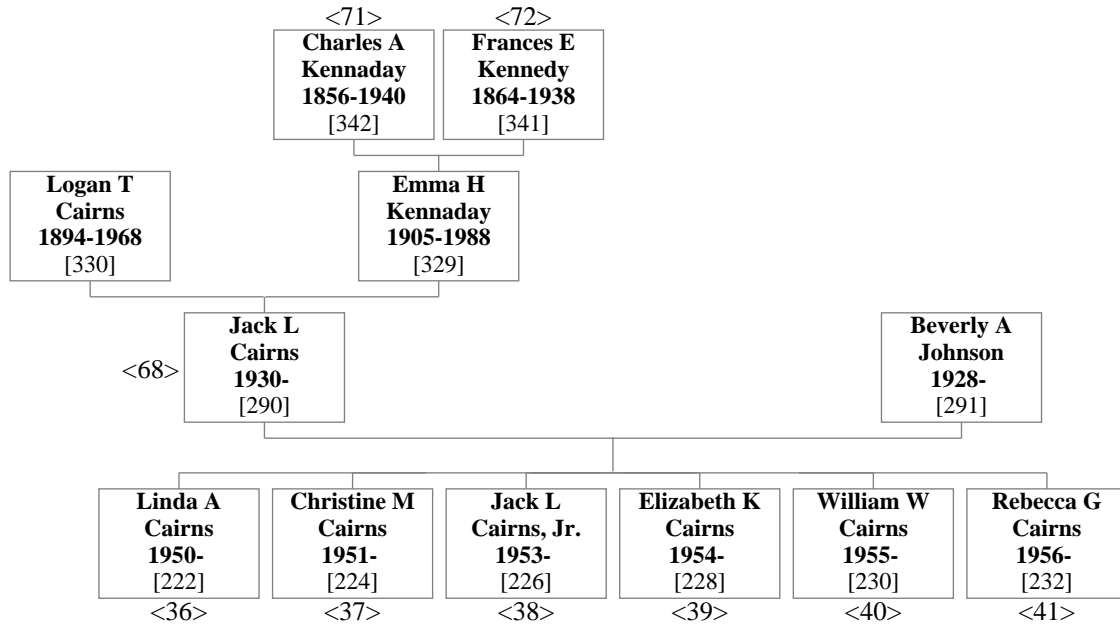

60. Albert Norman Wilson & Margaret Faunita Cairns

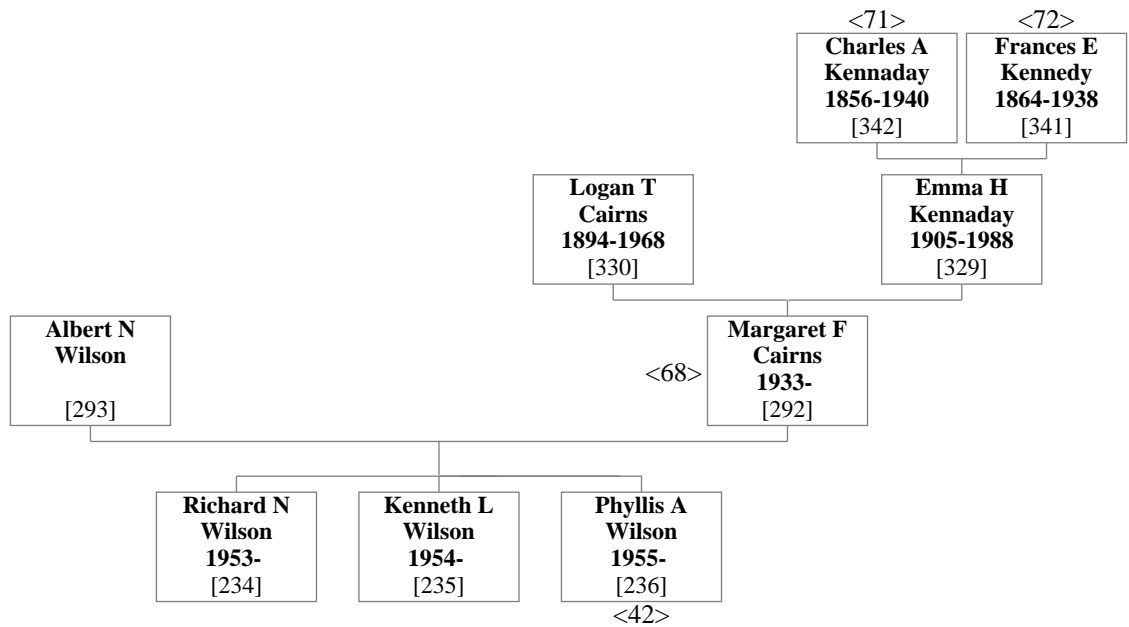

61. Craig Martin Schmeling & Judy Ann Cairns

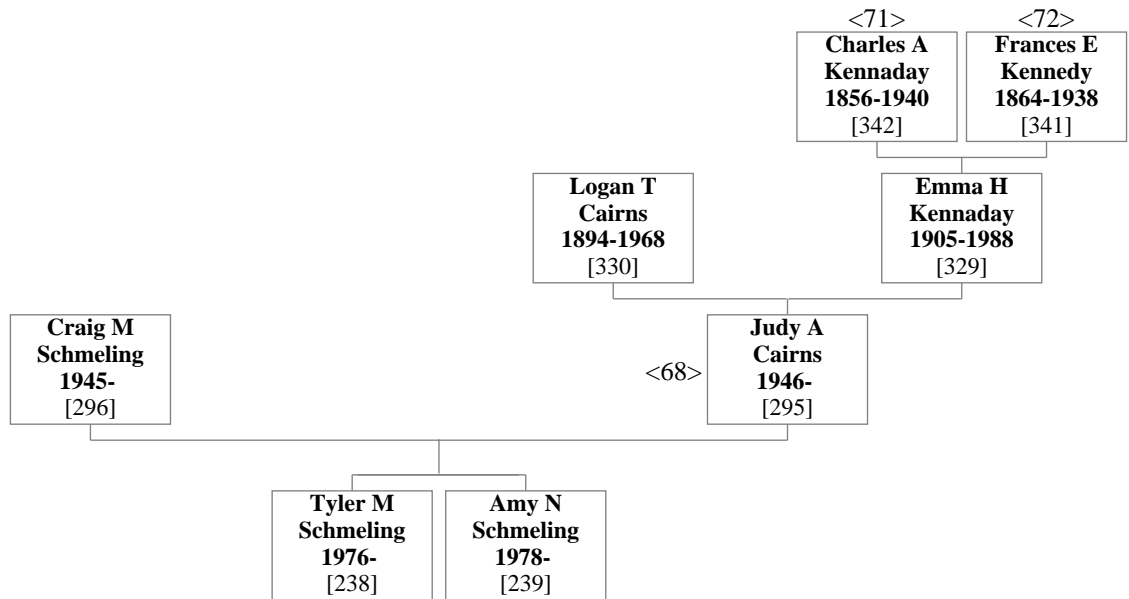

62. Fred Peters & Rosa Marie Kennaday

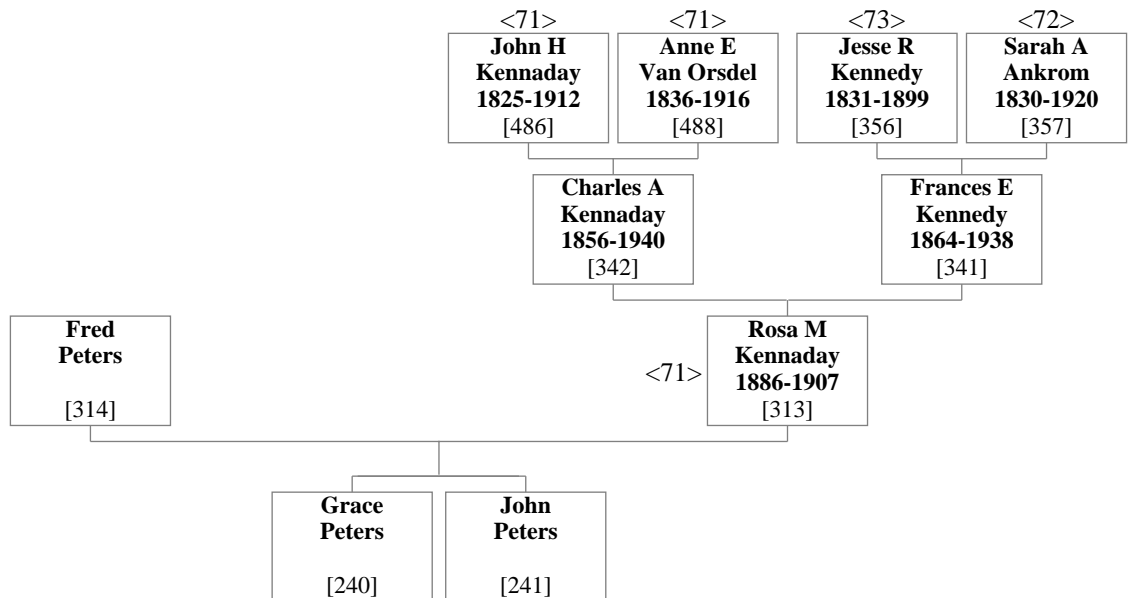

63. Ed Stewart & Anna Ruth Kennaday

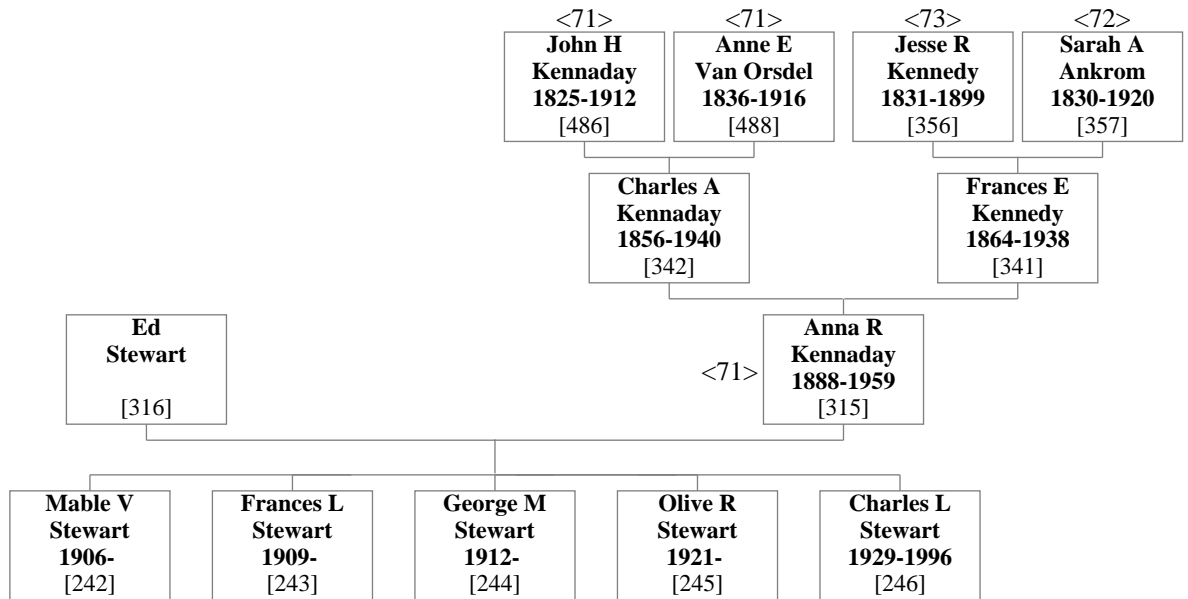

64. Frank Forest Kennaday & Mable Pierce

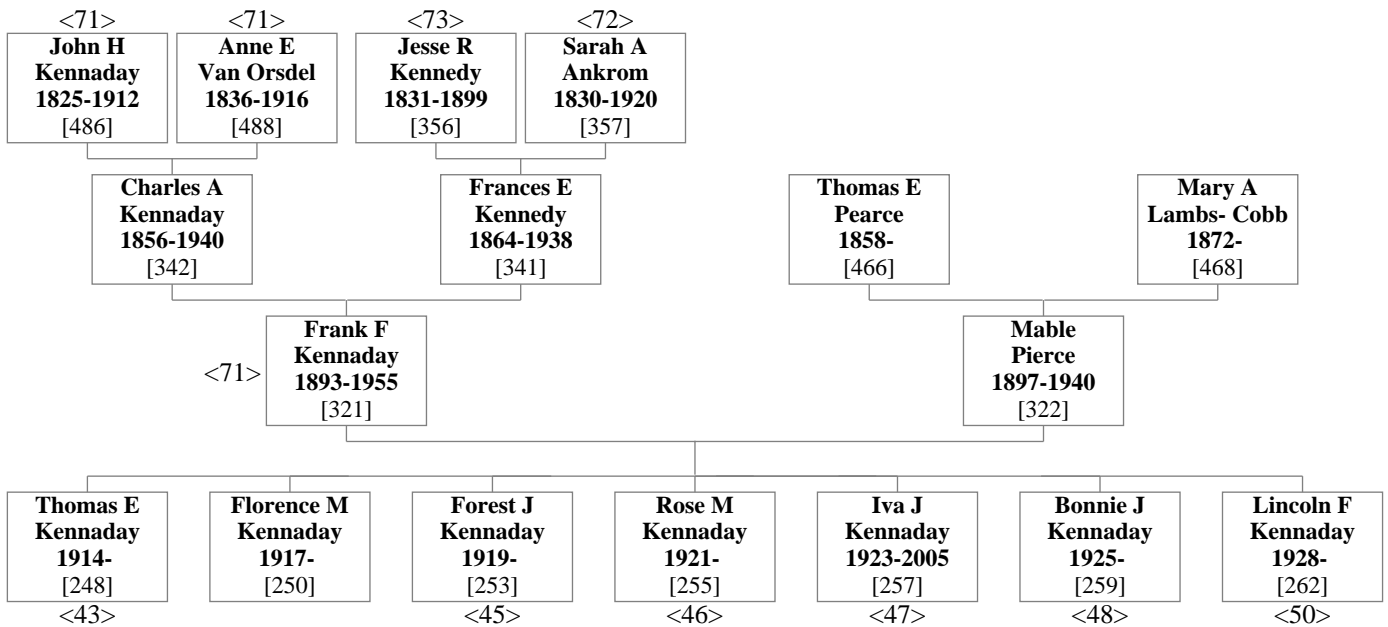

65. Edward Thomas Kennaday & Alice Mannahan

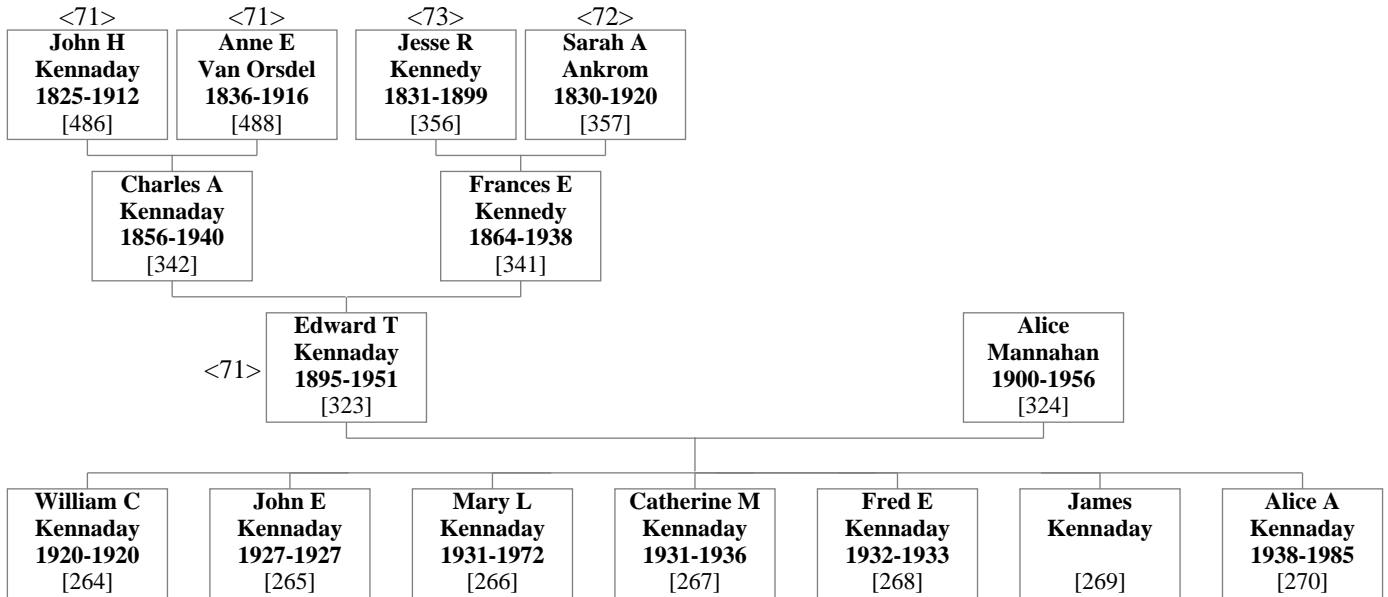

66. Fairfax Harry Davidson & Alice Oda May Kennaday

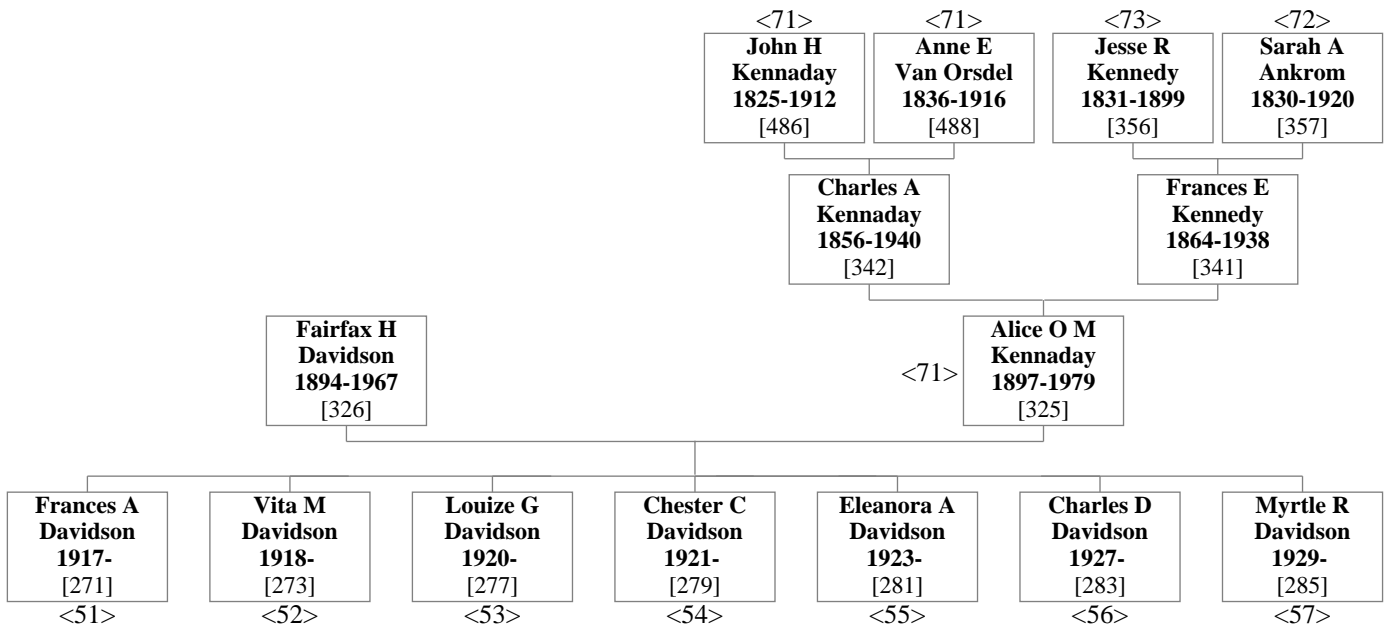

67. Charles Fredrick Kennaday & Margaret Bays

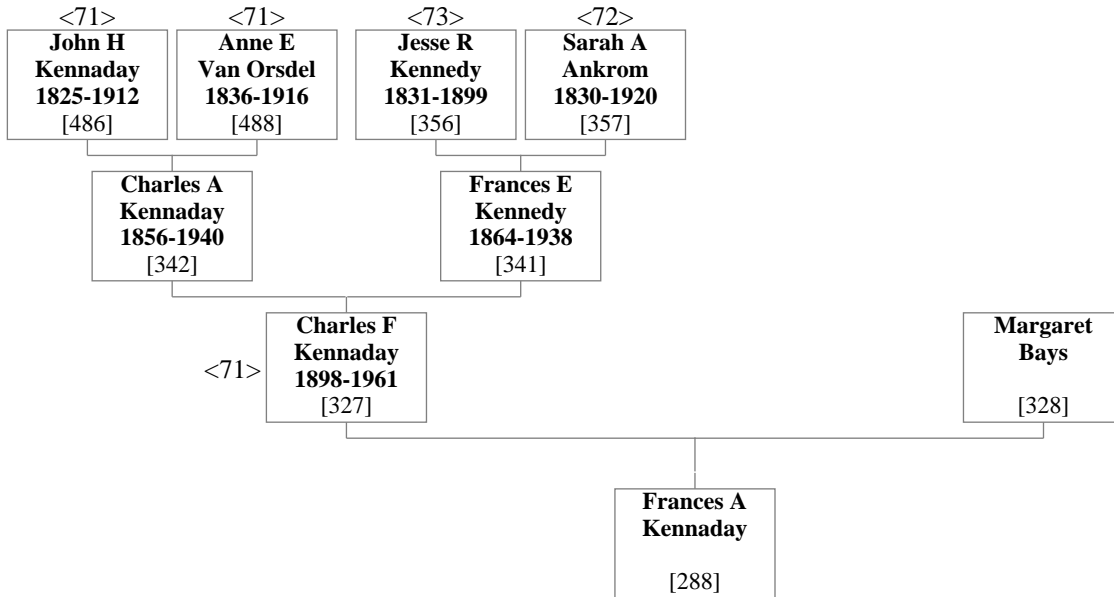

68. Logan Turner Cairns & Emma Helen Kennaday

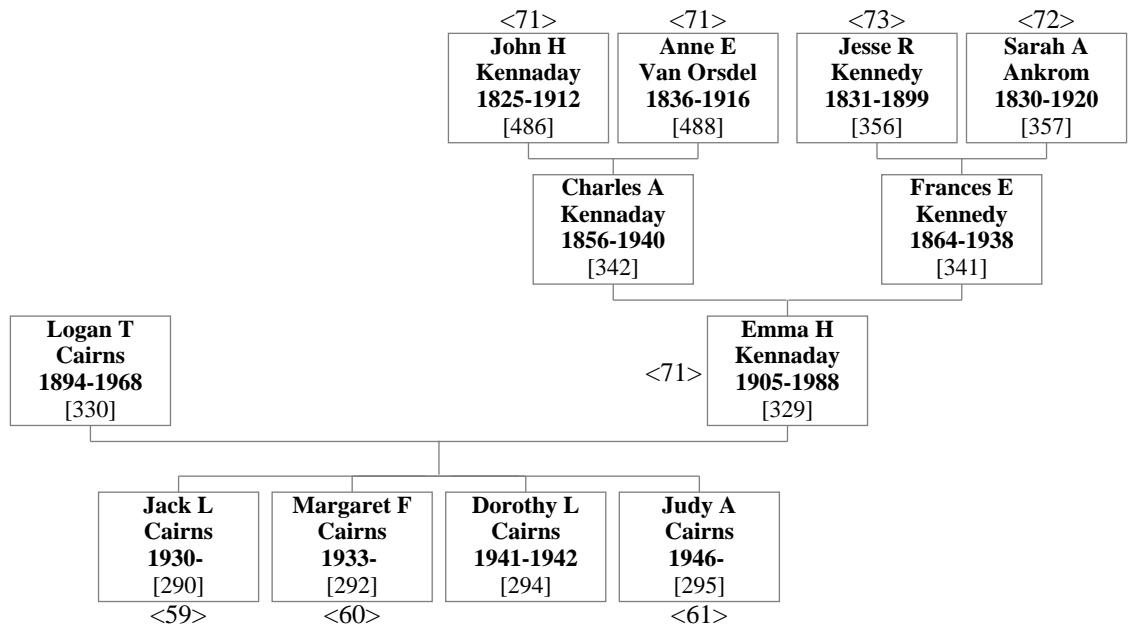

69. Alferd Shidler & Mariah Kennedy

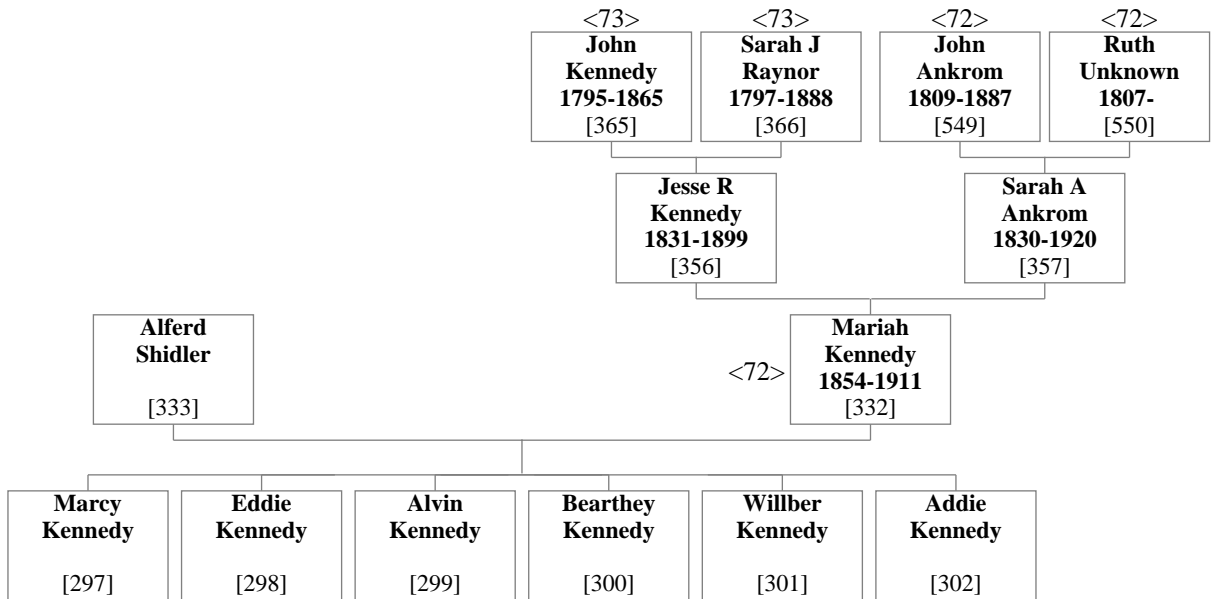

70. John Ronnie Kennedy & Nancy Alice Martindale

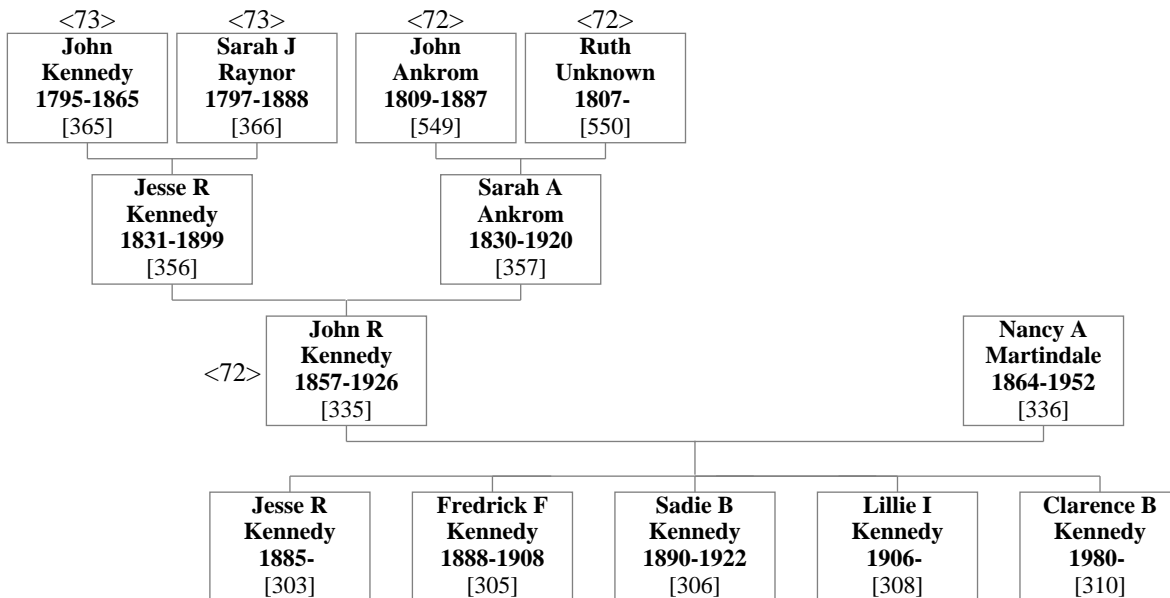

71. Charles Alonzo Kennaday & Frances Elizabeth Kennedy

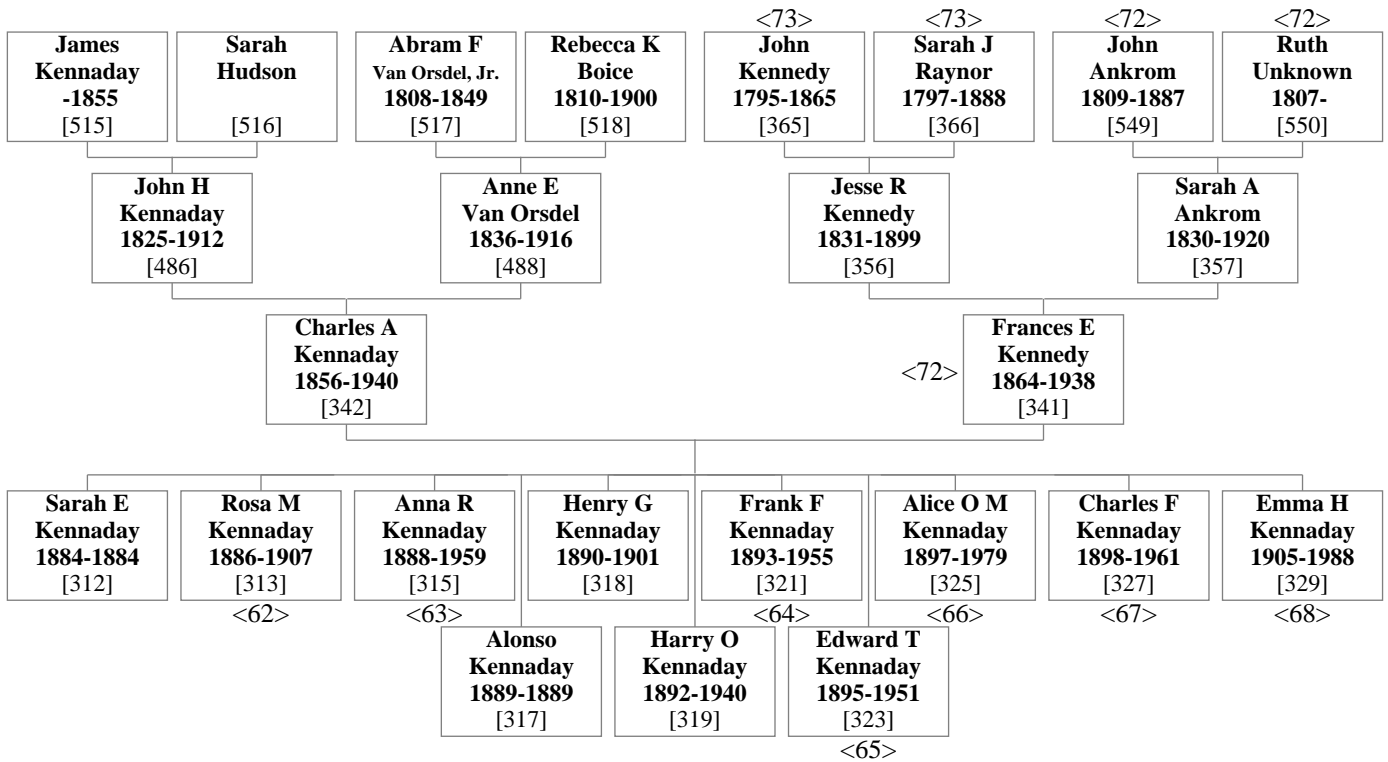

72. Jesse Rufus Kennedy & Sarah Ann Ankrom

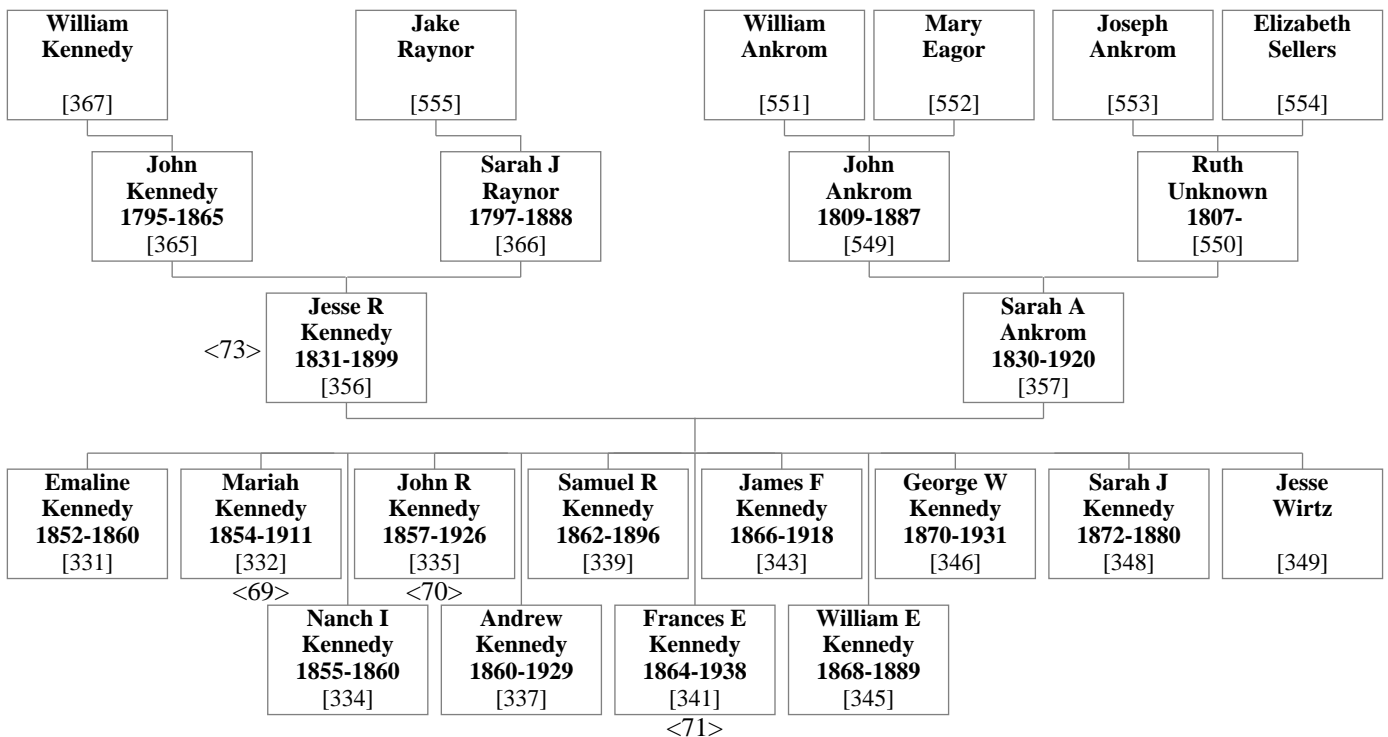

73. John Kennedy & Sarah Jane Raynor

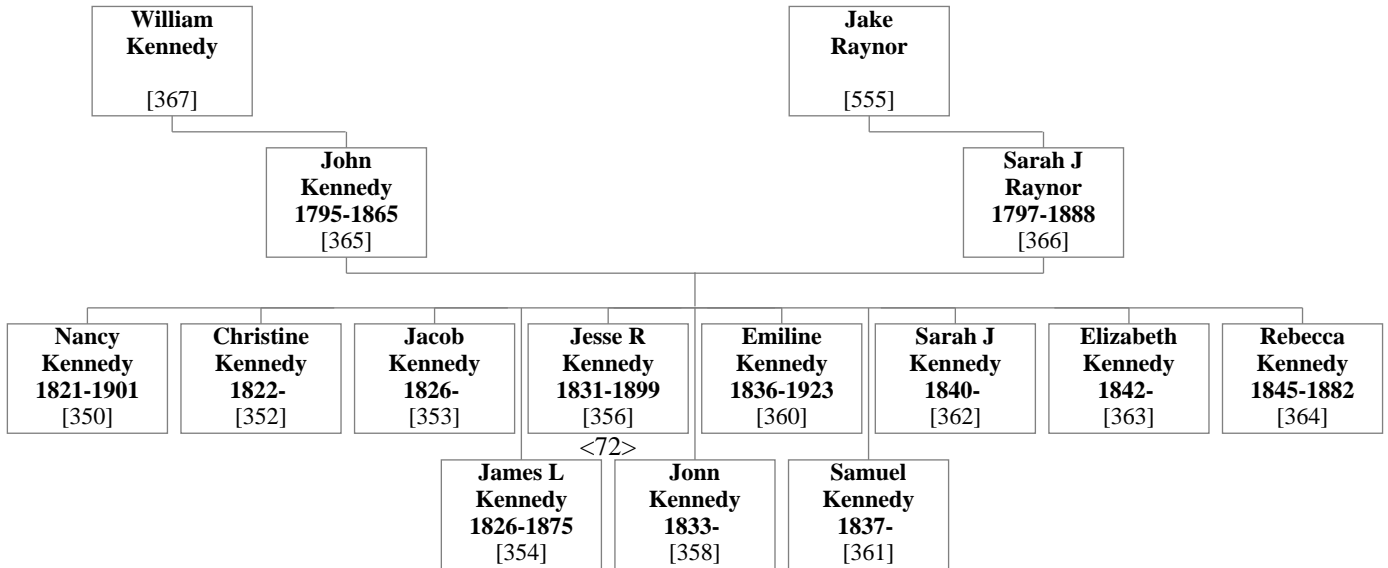

16. INDEX OF PLACES

1951

Birth of Rita Dianne Rhoads¹⁶².

AD RICHEYS HOME IN MYERS STATION

Death of Lewis Kelley⁴⁵¹ on 25 July 1932.

CARLISLE KENTUCKY, CARLISLE CEMETARY

Burial of John David Kelley²⁵⁸.

COLORADO, DENVER

Marriage of Thomas Earl Pearce⁴⁶⁶ and Mary Adele Lambs- Cobb⁴⁶⁸.

Birth of Alice Pearce⁴⁶⁴ on 28 December 1893.

Birth of Mable Pierce³²² on 5 January 1897.

CREMATION: ASHES ON GRAVE OF MELONY JO CURTIS DAUGHTER

Burial of Carolyn June Kelley¹⁵².

ENGLAND, LONDON

Birth of James Phipps⁴⁶⁷.

Birth of Thomas Earl Pearce⁴⁶⁶ on 6 June 1858.

ILLINOIS, MACON, BOODY

Birth of James Franklin Kennedy³⁴³ on 15 November 1866.

Birth of William Edson Kennedy³⁴⁵ on 15 October 1868.

INDIANA, INDIANAPOLIS, WASHINGTON PARK CEMETERY

Burial of Ronald David Kelley, Jr.⁵⁶.

IRELAND, DUBLIN

Birth of James Kennaday⁵¹⁵.

Birth of John Kennedy³⁶⁵ on 9 January 1795.

KENNADAY RANCH

Burial of Anne Elizabeth Van Orsdel⁴⁸⁸.

KENTUCKY, CARLISLE, CARLISLE CEMETARY

Burial of Iva June Kennaday²⁵⁷.

KENTUCKY, CARLISLE, CEMETERY, CARLISLE

Burial of Melony Jo Curtis⁶⁶.

MISSOURI, MACON

Birth of Mary Adele Lambs- Cobb⁴⁶⁸ on 24 September 1872.

NICARAQUA, MANAQUA

Birth of Caitlin Arlena Boyd¹ in 1992.

NOBEL

Marriage of Jonn Kennedy³⁵⁸ and Lydia Jarvis³⁵⁹ on 6 October 1861.

OHIO

Marriage of Jesse Rufus Kennedy³⁵⁶ and Sarah Ann Ankrom³⁵⁷ on 11 December 1851.

OREGON

Birth of Todd Kennaday³¹ on 5 May 1960.

PENNSYLVANIA USA, GREEN, WAYNESBURG

Birth of Sarah Jane Raynor³⁶⁶ on 10 October 1797.

Birth of James Leighton Kennedy³⁵⁴ on 10 November 1826.

PENNSYLVANIA USA, GREEN, WANYNESBURG

Birth of Jacob Kennedy³⁵³ on 10 November 1826.

TENNESSE

Birth of Cristian Hunnicutt⁵¹.

TENNESSEE

Marriage of James M Minton⁴⁵³ and Margaret Johnson⁴⁵⁴.

TEXAS, ANTONIO

Marriage of Thomas Eugene Kennaday¹²⁴ and Janice Benson¹²⁵ in 1960.

USA AT CHURCH OF CRIST, KANSAS, CHAUAUQUA, CEDARVALE

Marriage of Charles Alonzo Kennaday³⁴² and Frances Elizabeth Kennedy³⁴¹ on 11 November 1883.

USA, ARIZONA, ORANGE, PHOENIX

Birth of Joyce Ellen Jorgensen³² in 1962.

USA, CALAFORINA, HUMBOLDT, BLUE LAKE

Birth of Olive Ruth Stewart²⁴⁵ in 1921.

Birth of Charles Leroy Stewart²⁴⁶ in 1929.

USA, CALAFORINA, ORANGE, ANAHEIM

Birth of Adam Malaki Kennaday⁷ in 1987.

Birth of Aaron Forest Kennaday⁸ in 1990.

USA, CALIFORINA, NAPA, VALLEJO

Birth of Karla Lynn Kennaday²⁴ on 8 July 1961.

Birth of Kathy Kay Kennaday²⁵ in 1962.

USA, CALIFORNIA, LOS ANGELES, BURBANK

Birth of Brigid Ann Young¹⁶⁹ in 1956.

USA, CALIFORNIA, SAN DIAGO, SAN DIAGO

Birth of Patricia Leigh Kennaday⁷⁶ in 1979.

USA, CALIFORNIA, VAN NUYS

Birth of Catherine Susan Lavelle¹⁶⁶ in 1956.

USA, CHEROKEE NATION

Birth of Mary V Kennaday⁴⁸⁰ on 12 January 1868.

USA, COLORADO, ADAMS, DENVER

Birth of Frances Amonda Davidson²⁷¹ in 1917.

USA, COLORADO, DENVER, DENVER

Marriage of Logan Turner Cairns³³⁰ and Emma Helen Kennaday³²⁹ on 3 December 1925.

USA, COLORADO, ELPASO, COLORADO SPRINGS

Birth of Ronald Otis Page²²³ in 1950.

USA, COLORADO, MOFFAT, CRAIG

Birth of Jeremy Alan Hansen¹⁰⁸ in 1975.

USA, COLORADO, PUEBLO

Birth of Ronald David Kelley, Sr.¹⁵⁰ on 10 September 1943.

USA, COLORADO, SUPERIOR

Birth of Gladys Eleanor Ream²⁴⁹ in 1914.

USA, IDAHO, BONNEVILLE, IDAHO FALLS

- Birth of Aaron Wayne Hansen¹⁰⁹ in 1976.
- Birth of Michael Brent Hansen¹¹⁰ in 1979.
- Birth of Amy Nicole Hansen¹¹¹ in 1981.
- Birth of Jacob Karl Hansen¹¹² in 1983.
- Birth of Dorci Kae Cairns¹¹³ in 1983.
- Birth of Jace William Cairns¹¹⁴ in 1988.
- Birth of Brindi Michelle Cairns¹¹⁵ in 1991.

USA, ILLINOIS, MCLEAN, LEXINGTON

- Birth of James Edward Kennaday⁴⁷⁸ on 15 July 1858.
- Birth of Ida Jane Kennaday⁴⁷⁹ on 4 April 1861.
- Birth of Anne E D Kennaday⁴⁸² on 29 April 1875.

USA, INDIANA, INDIANAPOLIS

- Birth of Christian David Hunnicutt⁹ on 10 January 1983.
- Death of Iva June Kennaday²⁵⁷ on 16 March 2005.

USA, INDIANA, KNOX

- Birth of James H Van Orsdel⁴⁹⁸ on 11 February 1830.
- Birth of Mary B Van Orsdel⁵⁰⁰ on 21 June 1834.
- Birth of Anne Elizabeth Van Orsdel⁴⁸⁸ on 1 August 1836.

USA, INDIANA, MARION, INDIANAPOLIS

- Birth of Norman Perry Curtis, Jr.⁶³ on 28 August 1966.
- Birth of Melony Jo Curtis⁶⁶ on 14 January 1970.
- Death of Melony Jo Curtis⁶⁶ on 8 December 1970.
- Birth of David Earl Curtis⁶⁸ on 17 April 1973.
- Birth of Mercedes Curtis¹⁵ in August 1994.
- Birth of Savanna June Curtis¹⁶ on 14 June 1995.
- Death of Ronald David Kelley, Jr.⁵⁶ on 15 September 1997.

USA, KANSAS, CHAUTAUQUA, CEADER VALE

- Death of Jesse Rufus Kennedy³⁵⁶ on 7 August 1899.

USA, KANSAS, CHAUTAUQUA, CEDER VALE

- Birth of George Washington Kennedy³⁴⁶ on 11 October 1870.
- Birth of Sarah Jane Kennedy³⁴⁸ on 11 December 1872.
- Birth of Andrew Jackson Kennaday⁴⁸⁴ on 15 July 1878.
- Birth of Sarah Elizabeth Kennaday³¹² on 1 November 1884.
- Birth of Jesse Rufus Kennedy³⁰³ on 17 May 1885.
- Birth of Rosa Marie Kennaday³¹³ on 22 January 1886.
- Birth of Fredrick Fay Kennedy³⁰⁵ on 21 January 1888.
- Birth of Anna Ruth Kennaday³¹⁵ on 30 January 1888.
- Birth of Alonso Kennaday³¹⁷ on 4 April 1889.
- Birth of Sadie Bell Kennedy³⁰⁶ on 2 January 1890.
- Birth of Henry George Kennaday³¹⁸ on 11 May 1890.
- Birth of Lillie Irene Kennedy³⁰⁸ on 4 May 1906.
- Death of Sarah Ann Ankrom³⁵⁷ on 29 March 1920.
- Death of Anna Ruth Kennaday³¹⁵ on 6 November 1959.
- Birth of Clarence Bland Kennedy³¹⁰ on 9 April 1980.

USA, KANSAS, COWLEY, WINDFIELD

- Birth of Emma H Kennaday⁴⁸³ on 10 September 1875.

USA, KENTUCKY, BOONE

- Marriage of John Hudson Kennaday⁴⁸⁶ and Anne Elizabeth Van Orsdel⁴⁸⁸ on 30 August 1855.

USA, KENTUCKY, BOURBON

Birth of Abram Van Orsdel⁵⁰⁹ on 31 December 1845.

USA, KENTUCKY, BOURBON, PARIS

Birth of Betty Carol Fitzpatrick¹⁵¹ on 14 April 1947.

USA, KENTUCKY, CARLISLE

Birth of Dorothy Mae Kelley³⁹⁴ on 3 December 1932.

Birth of Eugene Kelley³⁹⁶ on 25 April 1935.

Birth of Juanita Kelley³⁹⁸ on 15 March 1937.

Birth of Mary Elizabeth Kelley⁴⁰¹ on 2 January 1939.

Birth of Wanda Lou Kelley⁴⁰³ on 22 February 1942.

Birth of Carolyn June Kelley¹⁵² on 8 February 1945.

Birth of Cristine Faye Kelley⁴⁰⁵ on 9 December 1945.

Birth of Brenda Jane Kelley⁴⁰⁸ on 25 August 1951.

Birth of James Luther Kelley, Jr.⁴⁰⁹ on 14 February 1953.

Birth of Bobby Gene Kelley³⁷² on 8 August 1954.

Birth of Freddie Warren Kelley⁴¹⁰ on 24 September 1954.

Birth of Donnie Lee Kelley⁴¹¹ on 25 November 1955.

Death of James Luther Kelley⁴¹⁹ on 27 March 1956.

Death of Freddie Warren Kelley⁴¹⁰ on 4 November 1956.

Birth of Billy Dean Kelley⁴¹² on 9 June 1958.

Death of Mary Elizabeth Minton⁴³⁰ on 26 January 1961.

Marriage of Norman Perry Curtis¹⁵³ and Carolyn June Kelley¹⁵² on 12 January 1963.

Marriage of Ronald David Kelley, Sr.¹⁵⁰ and Betty Carol Fitzpatrick¹⁵¹ on 6 April 1963.

Birth of Lisa June Kelley⁵⁰ on 18 December 1963.

Death of John David Kelley²⁵⁸ on 12 April 1970.

USA, KENTUCKY, CITY POWEL, CLAY

Death of Rebecca K Boice⁵¹⁸ on 6 April 1900.

USA, KENTUCKY, CLAY

Birth of Charles Alonzo Kennaday³⁴² on 8 November 1856.

USA, KENTUCKY, CYNTHIANA

Birth of James Mickel Asbury⁵².

USA, KENTUCKY, FAYETTE, LEXINGTON

Birth of Rebecca Ellen Van Orsdel⁵⁰² on 24 February 1839.

Birth of Melinda Catherine Van Orsdel⁵⁰⁴ on 14 October 1841.

USA, KENTUCKY, FLEMMINGBURG

Marriage of John David Kelley²⁵⁸ and Iva June Kennaday²⁵⁷ on 8 August 1948.

USA, KENTUCKY, LEXINGTON

Birth of Ronald David Kelley, Jr.⁵⁶ on 9 June 1966.

Birth of James Mathew Asbury¹⁰ on 28 June 1991.

USA, KENTUCKY, MERCER, HARRISBURG

Birth of Katie Boice⁵²¹.

Birth of Jacob Boice⁵²³.

Birth of Rebecca K Boice⁵¹⁸ on 16 April 1810.

Marriage of Gideon Wood⁵²⁰ and Mary B Boice⁵¹⁹ in 1820.

Birth of William George Van Orsdel⁴⁹⁶ on 15 December 1827.

USA, KENTUCKY, NICHLOS, ICARLISLE

Birth of Anita Carol Curtis⁵⁷ on 9 April 1964.

USA, KENTUCKY, OWEN

Birth of Henry George Van Orsdel⁵¹² on 17 June 1849.

USA, KENTUCKY, SCOTT, CYNTHIANA

Birth of Sarah E Van Orsdel⁵⁰⁶ on 31 August 1843.
 Birth of Isabell Van Orsdel⁵¹⁰ on 1 December 1846.

USA, MISSOURI

Marriage of George Washington Kennedy³⁴⁶ and Mary Elizabeth Skelton³⁴⁷ on 7 April 1889.

USA, MISSOURI, BARRY, SELIGMAN

Birth of Mary Elizabeth Skelton³⁴⁷ on 14 August 1863.

USA, MISSOURI, GREEN, SPRINGFIELD

Birth of John W Kennaday⁴⁸¹ on 5 November 1870.

USA, MISSOURI, POLK

Death of Nancy Alice Martindale³³⁶ on 27 August 1952.

USA, NEW JERSEY

Birth of Jacob Scomp⁵³⁵.

USA, NEW MEXICO, RIO ARRIBA, EL VADO

Birth of James Martin Marier²⁶¹ on 22 February 1920.

USA, NEW YORK, YONKERS

Birth of John Ellery Cooper²³³ in 1954.

USA, OHIO, CLEVELAND

Birth of James Vencent Boyd¹⁹ in 1956.

USA, OHIO, GURNSEY

Birth of Jesse Rufus Kennedy³⁵⁶ on 2 March 1831.

USA, OHIO, JACKSONTOWNSH

Death of John Kennedy³⁶⁵ on 10 August 1865.

USA, OHIO, NOBLE

Birth of Emiline Kennedy³⁶⁰ on 9 January 1836.

USA, OHIO, VENTON, ZALESKI

Birth of Frances Elizabeth Kennedy³⁴¹ on 19 September 1864.

USA, OHIO, VINTON

Birth of Jonn Kennedy³⁵⁸ on 19 June 1833.
 Birth of Rebecca Kennedy³⁶⁴ on 9 April 1845.
 Birth of John Ronnie Kennedy³³⁵ on 26 December 1857.
 Birth of Andrew Kennedy³³⁷ on 20 August 1860.

USA, OHIO, VINTON, ZALESKI

Birth of Samuel Kennedy³⁶¹ on 28 February 1837.
 Birth of Sarah Jane Kennedy³⁶² on 16 June 1840.

USA, OREGON, DOUGLAS, GLIDE

Birth of Joshua Jolin Kennaday⁷³ in 1982.

USA, OREGON, DOUGLAS, ROSEBURG

Birth of Joan Olivia Debernardi²⁶³ on 30 April 1929.
 Birth of Gary Jo Kennaday¹⁶¹ on 4 March 1946.
 Birth of David Debernardi Kennaday¹⁶³ on 8 January 1949.
 Birth of Paula Jo Smith¹⁶⁴ in 1953.
 Birth of Steven Scott Kennaday¹⁶⁵ on 5 March 1956.

USA, OREGON, DOUGLAS, ROSEBURG (continued)

- Birth of Fredrick Frank Kennaday¹⁶⁸ on 5 May 1957.
- Birth of Nicholas Isaiah Kennaday⁷⁰ in 1978.
- Birth of Elizabeth Alta Olivia Kennaday⁷¹ in 1980.
- Birth of Anthony Joseph Kennaday⁷⁷ in 1981.
- Birth of Cristina Dianne Kennaday⁷² in 1982.

USA, ORGAN, JACKSON, MEDFORD

- Birth of Randy Eugene Sobo²⁰ on 7 July 1959.
- Birth of Teresa Lynn Sobo²² on 19 August 1960.
- Birth of Justin Kyle Sobo³ in 1982.
- Birth of Julie Erin Sobo⁴ in 1985.
- Birth of Tyler Jamison Sobo⁶ in 1987.
- Birth of Travis Andrew Sobo⁵ in 1987.

USA, ORGAN, KLAMATH, FALLS, KLAMATH

- Birth of Brenda Sue Sobo¹⁸ on 22 March 1958.

USA, ORGAND, WASHINGTON, PORTLAND

- Birth of August Henry Geppert¹²⁷ in 1937.
- Birth of Lori Ann Geppert²⁶ on 18 February 1960.
- Birth of Judy Arlene Geppert²⁸ in 1962.
- Birth of Tommy Duane Geppert³⁰ in 1964.

USA, PENNSYLVANIA, GREEN

- Birth of John Ankrom⁵⁴⁹ on 9 August 1809.
- Birth of Richard Ankrom⁵³⁸ on 5 February 1827.
- Birth of Solomon Ankrom⁵³⁹ on 8 August 1828.
- Birth of Sarah Ann Ankrom³⁵⁷ on 12 September 1830.
- Birth of John Ellery Ankrom⁵⁴⁰ on 2 June 1833.
- Birth of Martha Ann Ankrom⁵⁴² on 4 November 1837.
- Birth of William Ankrom⁵⁴³ on 7 April 1840.
- Birth of Uriah Ankrom⁵⁴⁴ on 29 May 1842.
- Birth of Elizabeth Ankrom⁵⁴⁵ on 27 June 1844.
- Birth of Miriah Ankrom⁵⁴⁶ on 28 December 1846.
- Birth of Clementine Ankrom⁵⁴⁷ on 21 November 1848.
- Birth of Thomas Ankrom⁵⁴⁸ on 1 May 1853.

USA, PENNSYLVANIA, GREEN, WANESBURG

- Birth of Nancy Kennedy³⁵⁰ on 1 January 1821.
- Birth of Christine Kennedy³⁵² on 11 July 1822.

USA, UTAH, CACHE, LOGAN

- Birth of Tiffany Anne Cooper¹¹⁶ in 1977.
- Birth of Hillary Rane Cooper¹¹⁸ in 1978.

USA, UTAH, IRON, CEDER CITY

- Birth of Kae Porter²³¹ in 1957.

USA, UTAH, SALT LAKE, SALT LAKE CITY

- Birth of Triana Marie Campbell¹⁰³ in 1978.
- Birth of Holly Ann Campbell¹⁰⁴ in 1980.
- Birth of Eric Raymond Campbell¹⁰⁵ in 1985.

USA, UTAH, WEBER, OGDEN

- Birth of Thomas Elliott Page¹⁰⁰ in 1971.

USA, WYOMING, CARBON

Death of Anne Elizabeth Van Orsdel⁴⁸⁸ on 10 February 1916.

USA, WYOMING, CARBON, DEC. 9 1940 AT SARATOGA

Burial of Charles Alonzo Kennaday³⁴².

USA, WYOMING, CARBON, HANNA

Birth of Beverly Ann Johnson²⁹¹ in 1928.

USA, WYOMING, CARBON, RAWLINS

Birth of Logan Turner Cairns³³⁰ in 1894.

Birth of Jack Lavoy Cairns²⁹⁰ in 1930.

Marriage of Thomas Earl Kennaday²⁴⁸ and Gladys Eleanor Ream²⁴⁹ on 13 May 1933.

Birth of Margaret Faunita Cairns²⁹² in 1933.

Birth of Patty Ray Kennaday¹²⁶ on 3 August 1937.

Birth of Dorothy Lorraine Cairns²⁹⁴ in 1941.

Birth of Judy Ann Cairns²⁹⁵ in 1946.

Birth of Christine Marie Cairns²²⁴ in 1951.

Birth of Richard Norman Wilson²³⁴ in 1953.

Birth of Kenneth Logan Wilson²³⁵ in 1954.

Birth of Elizabeth Kay Cairns²²⁸ in 1954.

Birth of Phyllis Ann Wilson²³⁶ in 1955.

Birth of William Wayne Cairns²³⁰ in 1955.

Birth of Rebecca Gay Cairns²³² in 1956.

Birth of Johnathan Jack Page¹⁰¹ in 1973.

Birth of Donald Grant Page¹⁰² in 1975.

Birth of Kreetta Ann Jebens¹¹⁹ in 1975.

Birth of Korey Kay Jebens¹²⁰ in 1977.

Death of Alice Oda May Kennaday³²⁵ on 6 December 1979.

Birth of Carlie Norman Jebens¹²¹ in 1979.

Death of Emma Helen Kennaday³²⁹ on 26 August 1988.

USA, WYOMING, CARBON, SARATOGA

Birth of Harry Otis Kennaday³¹⁹ on 8 October 1892.

Birth of Frank Forest Kennaday³²¹ on 6 November 1893.

Birth of Edward Thomas Kennaday³²³ on 9 October 1895.

Birth of Alice Oda May Kennaday³²⁵ on 13 April 1897.

Birth of Charles Fredrick Kennaday³²⁷ on 30 November 1898.

Birth of Alice Mannahan³²⁴ in 1900.

Birth of Loyd Andrew Kennaday⁴⁷⁵ on 2 August 1903.

Birth of Emma Helen Kennaday³²⁹ on 8 December 1905.

Birth of Fay Kennaday⁴⁷⁷ on 14 June 1907.

Birth of Thomas Earl Kennaday²⁴⁸ on 7 July 1914.

Birth of Florence Mae Kennaday²⁵⁰ on 28 June 1917.

Birth of Vita Maude Davidson²⁷³ in 1918.

Birth of Forest Jack Kennaday²⁵³ on 22 November 1919.

Birth of Ellen (Dude) Stockwell²⁵⁴ in 1919.

Birth of William C Kennaday²⁶⁴ in 1920.

Birth of Louize Gertrude Davidson²⁷⁷ in 1920.

Birth of Rose Marie Kennaday²⁵⁵ on 10 October 1921.

Birth of Iva June Kennaday²⁵⁷ on 13 June 1923.

Death of Andrew Jackson Kennaday⁴⁸⁴ on 8 December 1923.

Birth of John E Kennaday²⁶⁵ in 1927.

Birth of Lincoln Frank Kennaday²⁶² on 9 April 1928.

Birth of Mary Lou Kennaday²⁶⁶ in 1931.

Birth of Catherine Marie Kennaday²⁶⁷ in 1931.

Birth of Fred E Kennaday²⁶⁸ in 1932.

Birth of Thomas Eugene Kennaday¹²⁴ on 14 August 1935.

Marriage of Loyd Andrew Kennaday⁴⁷⁵ and Inez Henderson⁴⁷⁶ on 23 October 1937.

Death of Frances Elizabeth Kennedy³⁴¹ on 10 June 1938.

Birth of Jack J Kennaday⁴⁶⁹ on 18 September 1938.

Birth of Alice Ann Kennaday²⁷⁰ in 1938.

USA, WYOMING, CARBON, SARATOGA (continued)

- Death of Mable Pierce³²² on 27 May 1940.
- Death of Charles Alonzo Kennaday³⁴² on 6 December 1940.
- Birth of Carl L Kennaday⁴⁷⁰ on 18 December 1940.
- Birth of Joy L Kennaday⁴⁷² on 17 April 1942.
- Birth of Donald Fay Kennaday⁴⁷⁴ on 18 May 1944.
- Death of Anna Marshel⁴⁸⁵ on 8 December 1960.
- Death of Inez Henderson⁴⁷⁶ on 22 September 1991.

USA, WYOMING, LARAMIE, CHEYENNE

- Death of Harry Otis Kennaday³¹⁹ on 25 April 1940.
- Birth of Amy Nichole Schmeling²³⁹ in 1978.

USA, WYOMING, PLATTE, WEATLAND

- Birth of Tyler Martin Schmeling²³⁸ in 1976.

USA, WYOMING, PLATTE, WHITTEMORE

- Birth of Craig Martin Schmeling²⁹⁶ in 1945.

USA, WYOMING, SUBLETTE, BIGPINEY

- Birth of Nelson Chester Whitman¹⁷⁰ in 1939.
- Birth of Boyd David Whitman¹⁷⁴ in 1940.
- Birth of Richard Ward Whitman¹⁷⁶ in 1941.
- Birth of Charlotte Louize Whitman¹⁷⁸ in 1944.

USA, WYOMING, SWEETWATER, ROCK SPRINGS

- Birth of Jack Lavoy Cairns, Jr.²²⁶ in 1953.

WYOMING, 1988 RAWLINS, AUG 30

- Burial of Emma Helen Kennaday³²⁹.

WYOMING, JUNE 13 1938 SARATOGA

- Burial of Frances Elizabeth Kennedy³⁴¹.

WYOMING, SARATOGA

- Burial of Harry Otis Kennaday³¹⁹.
- Marriage of Fred Peters³¹⁴ and Rosa Marie Kennaday³¹³ on 7 March 1904.
- Death of Rosa Marie Kennaday³¹³ on 22 July 1907.

17. INDEX OF DATES

- 1795** Birth of John Kennedy³⁶⁵ on 9 January, in Dublin, Ireland.
- 1797** Birth of Sarah Jane Raynor³⁶⁶ on 10 October, in Waynesburg, Green, Pennsylvania USA.
- 1807** Birth of Ruth Unknown⁵⁵⁰ on 2 April.
- 1808** Birth of Abram F Van Orsdel, Jr.⁵¹⁷.
- 1809** Birth of John Ankrom⁵⁴⁹ on 9 August, in Green, Pennsylvania, USA.
- 1810** Birth of Rebecca K Boice⁵¹⁸ on 16 April, in Harrisburg, Mercer, Kentucky, USA.
- 1818** Marriage of John Kennedy³⁶⁵ and Sarah Jane Raynor³⁶⁶.
- 1820** Marriage of Gideon Wood⁵²⁰ and Mary B Boice⁵¹⁹ in Harrisburg, Mercer, Kentucky, USA.
- 1821** Birth of Nancy Kennedy³⁵⁰ on 1 January, in Wanesburg, Green, Pennsylvania, USA.
- 1822** Birth of Christine Kennedy³⁵² on 11 July, in Wanesburg, Green, Pennsylvania, USA.
- 1823** Birth of Joseph Bryson Kennaday⁴⁸⁹ on 22 February.
- 1825** Birth of John Hudson Kennaday⁴⁸⁶ on 13 June.
- 1826** Marriage of John Ankrom⁵⁴⁹ and Ruth Unknown⁵⁵⁰ on 7 May.
Birth of Jacob Kennedy³⁵³ on 10 November, in Wanyesburg, Green, Pennsylvania USA.
Birth of James Leighton Kennedy³⁵⁴ on 10 November, in Waynesburg, Green, Pennsylvania USA.
- 1827** Birth of Richard Ankrom⁵³⁸ on 5 February, in Green, Pennsylvania, USA.
Marriage of Abram F Van Orsdel, Jr.⁵¹⁷ and Rebecca K Boice⁵¹⁸ on 27 February.
Birth of William George Van Orsdel⁴⁹⁶ on 15 December, in Harrisburg, Mercer, Kentucky, USA.
- 1828** Birth of Zarilda Kennaday⁴⁹⁰ on 16 March.
Birth of Solomon Ankrom⁵³⁹ on 8 August, in Green, Pennsylvania, USA.
- 1830** Birth of James H Van Orsdel⁴⁹⁸ on 11 February, in Knox, Indiana, USA.
Birth of Sarah Ann Ankrom³⁵⁷ on 12 September, in Green, Pennsylvania, USA.
- 1831** Birth of Jesse Rufus Kennedy³⁵⁶ on 2 March, in Gurnsey, Ohio, USA.
- 1833** Birth of John Ellery Ankrom⁵⁴⁰ on 2 June, in Green, Pennsylvania, USA.
Birth of Jonn Kennedy³⁵⁸ on 19 June, in Vinton, Ohio, USA.
- 1834** Marriage of Edward Kelley⁴⁵⁹ and America Mull⁴⁶⁰ on 16 February.
Birth of Mary Vicker Kennaday⁴⁹¹ on 18 March.
Birth of Mary B Van Orsdel⁵⁰⁰ on 21 June, in Knox, Indiana, USA.
- 1835** Birth of Mary Ann Ankrom⁵⁴¹ on 14 July.
- 1836** Birth of Emiline Kennedy³⁶⁰ on 9 January, in Noble, Ohio, USA.
Birth of Anne Elizabeth Van Orsdel⁴⁸⁸ on 1 August, in Knox, Indiana, USA.
- 1837** Birth of Samuel Kennedy³⁶¹ on 28 February, in Zaleski, Vinton, Ohio, USA.
Birth of Martha Ann Ankrom⁵⁴² on 4 November, in Green, Pennsylvania, USA.
- 1839** Birth of Rebecca Ellen Van Orsdel⁵⁰² on 24 February, in Lexington, Fayette, Kentucky, USA.
- 1840** Birth of William Ankrom⁵⁴³ on 7 April, in Green, Pennsylvania, USA.
Birth of Sarah Jane Kennedy³⁶² on 16 June, in Zaleski, Vinton, Ohio, USA.

1841

Birth of Melinda Catherine Van Orsdel⁵⁰⁴ on 14 October, in Lexington, Fayette, Kentucky, USA.

1842

Birth of Uriah Ankrom⁵⁴⁴ on 29 May, in Green, Pennsylvania, USA.

Birth of Elizabeth Kennedy³⁶³ on 16 June.

Marriage of Benjamin Kirk Shepherd³⁵¹ and Nancy Kennedy³⁵⁰ on 29 December.

1843

Birth of Sarah E Van Orsdel⁵⁰⁶ on 31 August, in Cynthiana, Scott, Kentucky, USA.

1844

Birth of Elizabeth Ankrom⁵⁴⁵ on 27 June, in Green, Pennsylvania, USA.

1845

Birth of Rebecca Kennedy³⁶⁴ on 9 April, in Vinton, Ohio, USA.

Birth of Abram Van Orsdel⁵⁰⁹ on 31 December, in Bourbon, Kentucky, USA.

1846

Death of Abram Van Orsdel⁵⁰⁹ on 4 January.

Birth of Isabell Van Orsdel⁵¹⁰ on 1 December, in Cynthiana, Scott, Kentucky, USA.

Birth of Miriah Ankrom⁵⁴⁶ on 28 December, in Green, Pennsylvania, USA.

1848

Birth of Clementine Ankrom⁵⁴⁷ on 21 November, in Green, Pennsylvania, USA.

1849

Birth of Henery George Van Orsdel⁵¹² on 17 June, in Owen, Kentucky, USA.

Death of Abram F Van Orsdel, Jr.⁵¹⁷.

1850

Death of Solomon Ankrom⁵³⁹ on 2 June.

Death of John Ellery Ankrom⁵⁴⁰ on 14 June.

1851

Marriage of William George Van Orsdel⁴⁹⁶ and Sarah Catterson⁴⁹⁷ on 22 February.

Birth of James M Minton⁴⁵³ on 3 April.

Marriage of Jesse Rufus Kennedy³⁵⁶ and Sarah Ann Ankrom³⁵⁷ on 11 December, in Ohio.

1852

Birth of Lewis Kelley⁴⁵¹ on 5 February.

Birth of Emaline Kennedy³³¹ on 25 October.

1853

Birth of Thomas Ankrom⁵⁴⁸ on 1 May, in Green, Pennsylvania, USA.

1854

Birth of Mariah Kennedy³³² on 13 March.

Marriage of James H Van Orsdel⁴⁹⁸ and Sallie Matoxx⁴⁹⁹ on 22 July.

1855

Death of James Kennaday⁵¹⁵ on 5 May.

Death of Martha Ann Ankrom⁵⁴² on 24 June.

Marriage of John Hudson Kennaday⁴⁸⁶ and Anne Elizabeth Van Orsdel⁴⁸⁸ on 30 August, in Boone, Kentucky, USA.

Birth of Nanch Isabell Kennedy³³⁴ on 25 December.

1856

Marriage of Erasmus E Kelley⁴⁵⁷ and Mary Mc Iwoan⁴⁵⁸ on 17 March.

Birth of Margaret Johnson⁴⁵⁴ on 8 May.

Birth of Charles Alonzo Kennaday³⁴² on 8 November, in Clay, Kentucky, USA.

1857

Birth of John Ronnie Kennedy³³⁵ on 26 December, in Vinton, Ohio, USA.

1858

Birth of Thomas Earl Pearce⁴⁶⁶ on 6 June, in London, England.

Birth of James Edward Kennaday⁴⁷⁸ on 15 July, in Lexington, Mclean, Illinois, USA.

1860

Marriage of William B Hewitt⁵⁰³ and Rebecca Ellen Van Orsdel⁵⁰² on 13 February.

Death of Emaline Kennedy³³¹ on 27 February.

Death of Uriah Ankrom⁵⁴⁴ on 3 March.

Death of Nanch Isabell Kennedy³³⁴ in March.

Birth of Andrew Kennedy³³⁷ on 20 August, in Vinton, Ohio, USA.

1861

Birth of Ida Jane Kennaday⁴⁷⁹ on 4 April, in Lexington, Mclean, Illinois, USA.

Marriage of Jonn Kennedy³⁵⁸ and Lydia Jarvis³⁵⁹ on 6 October, in Nobel.

Marriage of John Benjamin Pollard⁵⁰⁵ and Melinda Catherine Van Orsdel⁵⁰⁴ on 31 December.

- 1862**
Birth of Samuel Rufus Kennedy³³⁹ on 24 October.
- 1863**
Death of William George Van Orsdel⁴⁹⁶ on 19 February.
Birth of Mary Elizabeth Skelton³⁴⁷ on 14 August, in Seligman, Barry, Missouri, USA.
- 1864**
Birth of Frances Elizabeth Kennedy³⁴¹ on 19 September, in Zaleski, Venton, Ohio, USA.
Birth of Nancy Alice Martindale³³⁶ on 2 November.
- 1865**
Birth of Pamela Frances Bowles⁴⁵² on 2 June.
Death of John Kennedy³⁶⁵ on 10 August, in JacksoTownsh, Ohio, USA.
- 1866**
Death of Clementine Ankrom⁵⁴⁷ on 8 April.
Birth of James Franklin Kennedy³⁴³ on 15 November, in Boody, Macon, Illinois.
Marriage of James H Wallace⁵¹¹ and Isabell Van Orsdel⁵¹⁰ on 25 December.
Marriage of Henery George Van Orsdel⁵¹² and Annie E Mitchell⁵¹³.
- 1868**
Birth of Mary V Kennaday⁴⁸⁰ on 12 January, in Cherokee Nation, USA.
Marriage of Thomas Rogers⁵⁰⁷ and Sarah E Van Orsdel⁵⁰⁶ on 3 July.
Birth of William Edson Kennedy³⁴⁵ on 15 October, in Boody, Macon, Illinois.
- 1869**
Death of Mary V Kennaday⁴⁸⁰ on 4 October.
- 1870**
Marriage of William S Kelley⁴⁵⁵ and Elizabeth Smith⁴⁵⁶ on 21 May.
Birth of George Washington Kennedy³⁴⁶ on 11 October, in Ceder Vale, Chautauqua, Kansas, USA.
Birth of John W Kennaday⁴⁸¹ on 5 November, in Springfield, Green, Missouri, USA.
- 1872**
Birth of Mary Adele Lambs- Cobb⁴⁶⁸ on 24 September, in Macon, Missouri.
Birth of Sarah Jane Kennedy³⁴⁸ on 11 December, in Ceder Vale, Chautauqua, Kansas, USA.
- 1875**
Death of Elizabeth Rhineheart³⁵⁵ on 19 March.
Death of James Leighton Kennedy³⁵⁴ on 19 March.
Birth of Anne E D Kennaday⁴⁸² on 29 April, in Lexington, Mclean, Illinois, USA.
Birth of Emma H Kennaday⁴⁸³ on 10 September, in Windfield, Cowley, Kansas, USA.
Birth of Anna Marshel⁴⁸⁵.
- 1876**
Birth of Della Minton⁴³⁹ on 26 February.
- 1877**
Marriage of Alferd Shidler³³³ and Mariah Kennedy³³² on 20 August.
Marriage of Henery George Van Orsdel⁵¹² and Mattie Anderson⁵¹⁴.
- 1878**
Birth of Andrew Jackson Kennaday⁴⁸⁴ on 15 July, in Ceder Vale, Chautauqua, Kansas, USA.
Birth of Mary Elizabeth Minton⁴³⁰ on 28 August.
- 1880**
Death of Sarah Jane Kennedy³⁴⁸ on 20 March.
Birth of Isabell May Minton⁴⁴⁰ on 15 May.
- 1882**
Death of Rebecca Kennedy³⁶⁴ on 1 January.
Marriage of Andrew Kennedy³³⁷ and Effie Bacus³³⁸ on 9 May.
Birth of Ida Catherine Minton⁴⁴¹ on 9 May.
Marriage of John Ronnie Kennedy³³⁵ and Nancy Alice Martindale³³⁶ on 6 September.
- 1883**
Death of Ida Jane Kennaday⁴⁷⁹ on 5 April.
Marriage of Charles Alonzo Kennaday³⁴² and Frances Elizabeth Kennedy³⁴¹ on 11 November, in Cedarvale, Chauauqua, Kansas, USA at Chiurch of Crist.
- 1884**
Birth of James Minton⁴⁴² on 7 August.
Marriage of Lewis Kelley⁴⁵¹ and Pamela Frances Bowles⁴⁵² on 14 October.
Birth of Sarah Elizabeth Kennaday³¹² on 1 November, in Ceder Vale, Chautauqua, Kansas, USA.
Death of Sarah Elizabeth Kennaday³¹² on 1 November.

1885

Birth of Jesse Rufus Kennedy³⁰³ on 17 May, in Ceder Vale, Chautauqua, Kansas, USA.

1886

Birth of Rosa Marie Kennaday³¹³ on 22 January, in Ceder Vale, Chautauqua, Kansas, USA.

Birth of Maggie Minton⁴⁴³ on 13 April.

Marriage of Samuel Rufus Kennedy³³⁹ and Lillie Tredway³⁴⁰ on 8 July.

Birth of Talmadge Blane Kelley⁴²⁹ on 12 July.

1887

Death of John Ankrom⁵⁴⁹ on 12 May.

1888

Birth of Fredrick Fay Kennedy³⁰⁵ on 21 January, in Ceder Vale, Chautauqua, Kansas, USA.

Birth of Anna Ruth Kennaday³¹⁵ on 30 January, in Ceder Vale, Chautauqua, Kansas, USA.

Death of Sarah Jane Raynor³⁶⁶ on 8 April.

Birth of Carrie Minton⁴⁴⁴ on 7 June.

Marriage of Noah Diehl⁵⁰⁸ and Sarah E Van Orsdel⁵⁰⁶ on 13 June.

Marriage of James Phipps⁴⁶⁷ and Mary Adele Lambs- Cobb⁴⁶⁸.

1889

Death of William Edson Kennedy³⁴⁵ on 12 March.

Birth of Alonso Kennaday³¹⁷ on 4 April, in Ceder Vale, Chautauqua, Kansas, USA.

Death of Alonso Kennaday³¹⁷ on 4 April.

Marriage of George Washington Kennedy³⁴⁶ and Mary Elizabeth Skelton³⁴⁷ on 7 April, in Missouri, USA.

1890

Birth of Sadie Bell Kennedy³⁰⁶ on 2 January, in Ceder Vale, Chautauqua, Kansas, USA.

Death of Isabell Van Orsdel⁵¹⁰ on 24 March.

Birth of Henry George Kennaday³¹⁸ on 11 May, in Ceder Vale, Chautauqua, Kansas, USA.

Birth of Rosayella Minton⁴⁴⁶ on 7 October.

1892

Birth of Phillys Minton⁴⁴⁷ on 8 October.

Birth of Harry Otis Kennaday³¹⁹ on 8 October, in Saratoga, Carbon, Wyoming, USA.

1893

Birth of Frank Forest Kennaday³²¹ on 6 November, in Saratoga, Carbon, Wyoming, USA.

Birth of Alice Pearce⁴⁶⁴ on 28 December, in Denver, Colorado.

1894

Birth of Walter Minton⁴⁴⁹ on 12 August.

Birth of Logan Turner Cairns³³⁰ in Rawlins, Carbon, Wyoming, USA.

Birth of Fairfax Harry Davidson³²⁶.

1895

Death of Sarah E Van Orsdel⁵⁰⁶ on 27 February.

Birth of Edward Thomas Kennaday³²³ on 9 October, in Saratoga, Carbon, Wyoming, USA.

1896

Death of Samuel Rufus Kennedy³³⁹ on 29 January.

Birth of Ethel Minton⁴⁵⁰ on 1 June.

1897

Birth of Mable Pierce³²² on 5 January, in Denver, Colorado.

Birth of Alice Oda May Kennaday³²⁵ on 13 April, in Saratoga, Carbon, Wyoming, USA.

1898

Birth of Charles Fredrick Kennaday³²⁷ on 30 November, in Saratoga, Carbon, Wyoming, USA.

1899

Marriage of James Franklin Kennedy³⁴³ and Louise Whited³⁴⁴ on 11 March.

Death of Joseph Bryson Kennaday⁴⁸⁹ on 20 May.

Death of Jesse Rufus Kennedy³⁵⁶ on 7 August, in Ceder Vale, Chautauqua, Kansas, USA.

1900

Death of Rebecca K Boice⁵¹⁸ on 6 April, in Clay, City Powel, Kentucky, USA.

Birth of Alice Mannahan³²⁴ in Saratoga, Carbon, Wyoming, USA.

1901

Death of Henry George Kennaday³¹⁸ on 20 May.

Death of Nancy Kennedy³⁵⁰.

1903

Birth of Loyd Andrew Kennaday⁴⁷⁵ on 2 August, in Saratoga, Carbon, Wyoming, USA.

1904

Marriage of Fred Peters³¹⁴ and Rosa Marie Kennaday³¹³ on 7 March, in Saratoga, Wyoming.

1905

Marriage of Ed Stewart³¹⁶ and Anna Ruth Kennaday³¹⁵ on 30 September.

Birth of Emma Helen Kennaday³²⁹ on 8 December, in Saratoga, Carbon, Wyoming, USA.

1906

Birth of Lillie Irene Kennedy³⁰⁸ on 4 May, in Ceder Vale, Chautauqua, Kansas, USA.

Birth of Mable Vilote Stewart²⁴².

1907

Death of Mary Vicker Kennaday⁴⁹¹ on 18 February.

Birth of Fay Kennaday⁴⁷⁷ on 14 June, in Saratoga, Carbon, Wyoming, USA.

Death of Rosa Marie Kennaday³¹³ on 22 July, in Saratoga, Wyoming.

1908

Marriage of Jay McClure³⁰⁷ and Sadie Bell Kennedy³⁰⁶ on 29 January.

Death of Fredrick Fay Kennedy³⁰⁵ on 29 November.

1909

Marriage of Talmadge Blane Kelley⁴²⁹ and Mary Elizabeth Minton⁴³⁰ on 16 December.

Birth of Frances Luella Stewart²⁴³.

1910

Marriage of Jesse Rufus Kennedy³⁰³ and Fay McClure³⁰⁴ on 6 April.

1911

Birth of James Luther Kelley⁴¹⁹ on 31 March.

Death of Mariah Kennedy³³² on 14 November.

Birth of Earl N Ramsey²⁵².

1912

Death of John Hudson Kennaday⁴⁸⁶ on 8 November.

Birth of George Martin Stewart²⁴⁴.

1913

Marriage of Frank Forest Kennaday³²¹ and Mable Pierce³²² on 4 July.

Birth of Walter Cecil Ackerson²⁸².

1914

Death of Mary B Van Orsdel⁵⁰⁰ on 11 March.

Birth of Thomas Earl Kennaday²⁴⁸ on 7 July, in Saratoga, Carbon, Wyoming, USA.

Birth of Gladys Eleanor Ream²⁴⁹ in Superior, Colorado, USA.

1915

Birth of Inez Henderson⁴⁷⁶ on 3 February.

Birth of Harvey Alton Blackburn²⁷⁸.

1916

Death of Anne Elizabeth Van Orsdel⁴⁸⁸ on 10 February, in Carbon, Wyoming, USA.

Marriage of Fairfax Harry Davidson³²⁶ and Alice Oda May Kennaday³²⁵ on 11 May.

1917

Birth of Talmadge Blane Kelley, Jr.⁴²¹ on 28 January.

Birth of Florence Mae Kennaday²⁵⁰ on 28 June, in Saratoga, Carbon, Wyoming, USA.

Death of James M Minton⁴⁵³ on 23 October.

Birth of Frances Amonda Davidson²⁷¹ in Denver, Adams, Colorado, USA.

1918

Death of James Franklin Kennedy³⁴³ on 21 January.

Marriage of Edward Thomas Kennaday³²³ and Alice Mannahan³²⁴ on 11 August.

Birth of John David Kelley²⁵⁸ on 29 December.

Birth of Vita Maude Davidson²⁷³ in Saratoga, Carbon, Wyoming, USA.

Birth of Robert Orrin Rogerson²⁷⁴.

1919

Birth of Cristine Sapp⁴²⁰ on 15 February.

Birth of Forest Jack Kennaday²⁵³ on 22 November, in Saratoga, Carbon, Wyoming, USA.

Birth of Ellen (Dude) Stockwell²⁵⁴ in Saratoga, Carbon, Wyoming, USA.

1920

Birth of James Martin Marier²⁶¹ on 22 February, in El Vado, Rio Arriba, New Mexico, USA.

Death of Sarah Ann Ankrom³⁵⁷ on 29 March, in Ceder Vale, Chautauqua, Kansas, USA.

Birth of William C Kennaday²⁶⁴ in Saratoga, Carbon, Wyoming, USA.

Birth of Bruce Douglas Whitman²⁷².

Death of William C Kennaday²⁶⁴.

Birth of Louize Gertrude Davidson²⁷⁷ in Saratoga, Carbon, Wyoming, USA.

- 1921**
 Death of Rebecca Ellen Van Orsdel⁵⁰² on 18 January.
 Birth of Rose Marie Kennaday²⁵⁵ on 10 October, in Saratoga, Carbon, Wyoming, USA.
 Birth of Olive Ruth Stewart²⁴⁵ in Blue Lake, Humboldt, Calaforina, USA.
 Birth of Chester Clark Davidson²⁷⁹.
- 1922**
 Death of Sadie Bell Kennedy³⁰⁶ on 5 December.
- 1923**
 Death of Emiline Kennedy³⁶⁰ on 19 May.
 Birth of Iva June Kennaday²⁵⁷ on 13 June, in Saratoga, Carbon, Wyoming, USA.
 Death of Andrew Jackson Kennaday⁴⁸⁴ on 8 December, in Saratoga, Carbon, Wyoming, USA.
 Birth of Eleanora Alice Davidson²⁸¹.
- 1925**
 Birth of Bonnie Jean Kennaday²⁵⁹ on 6 April.
 Marriage of Logan Turner Cairns³³⁰ and Emma Helen Kennaday³²⁹ on 3 December, in Denver, Denver, Colorado, USA.
- 1926**
 Death of John Ronnie Kennedy³³⁵ on 20 January.
- 1927**
 Birth of John E Kennaday²⁶⁵ in Saratoga, Carbon, Wyoming, USA.
 Death of John E Kennaday²⁶⁵.
 Birth of Charles Daniel Davidson²⁸³.
- 1928**
 Birth of Lincoln Frank Kennaday²⁶² on 9 April, in Saratoga, Carbon, Wyoming, USA.
 Birth of Beverly Ann Johnson²⁹¹ in Hanna, Carbon, Wyoming, USA.
- 1929**
 Birth of Joan Olivia Debernardi²⁶³ on 30 April, in Roseburg, Douglas, Oregon, USA.
 Death of Andrew Kennedy³³⁷ on 12 September.
 Birth of Charles Leroy Stewart²⁴⁶ in Blue Lake, Humboldt, Calaforina, USA.
 Birth of Myrtle Rae Davidson²⁸⁵.
 Birth of Earlene Dee Noller²⁸⁴.
- 1930**
 Birth of Jack Lavoy Cairns²⁹⁰ in Rawlins, Carbon, Wyoming, USA.
- 1931**
 Death of Talmadge Blane Kelley⁴²⁹ on 6 February.
 Death of George Washington Kennedy³⁴⁶ on 30 March.
 Birth of Mary Lou Kennaday²⁶⁶ in Saratoga, Carbon, Wyoming, USA.
 Birth of Catherine Marie Kennaday²⁶⁷ in Saratoga, Carbon, Wyoming, USA.
- 1932**
 Marriage of James Luther Kelley⁴¹⁹ and Cristine Sapp⁴²⁰ on 10 June.
 Death of Lewis Kelley⁴⁵¹ on 25 July, in Ad Richeys home in Myers station.
 Birth of Dorothy Mae Kelley³⁹⁴ on 3 December, in Carlisle, Kentucky, USA.
 Birth of Fred E Kennaday²⁶⁸ in Saratoga, Carbon, Wyoming, USA.
- 1933**
 Marriage of Thomas Earl Kennaday²⁴⁸ and Gladys Eleanor Ream²⁴⁹ on 13 May, in Rawlins, Carbon, Wyoming, USA.
 Marriage of Charles Fredrick Kennaday³²⁷ and Margaret Bays³²⁸ on 18 July.
 Birth of Charlotte Arlene Kennaday¹²² on 28 October.
 Birth of Cornell Alexander Sobo, Jr.¹²³ on 28 October.
 Birth of Margaret Faunita Cairns²⁹² in Rawlins, Carbon, Wyoming, USA.
 Death of Fred E Kennaday²⁶⁸.
- 1934**
 Death of James Edward Kennaday⁴⁷⁸ on 6 June.
 Death of Melinda Catherine Van Orsdel⁵⁰⁴ on 6 June.
- 1935**
 Birth of Eugene Kelley³⁹⁶ on 25 April, in Carlisle, Kentucky, USA.
 Birth of Thomas Eugene Kennaday¹²⁴ on 14 August, in Saratoga, Carbon, Wyoming, USA.
 Marriage of Earl N Ramsey²⁵² and Florence Mae Kennaday²⁵⁰ on 21 October.
 Birth of Ronald Clark Redman²⁸⁷.
- 1936**
 Death of Catherine Marie Kennaday²⁶⁷.

1937

Birth of Juanita Kelley³⁹⁸ on 15 March, in Carlisle, Kentucky, USA.
 Birth of Earl Efton (Butch) Ramsey¹²⁸ on 24 April.
 Birth of Patty Ray Kennaday¹²⁶ on 3 August, in Rawlins, Carbon, Wyoming, USA.
 Birth of Rosa L Hubbard¹²⁹ on 26 September.
 Marriage of Loyd Andrew Kennaday⁴⁷⁵ and Inez Henderson⁴⁷⁶ on 23 October, in Saratoga, Carbon, Wyoming, USA.
 Birth of August Henry Geppert¹²⁷ in Portland, Washington, Oregon, USA.

1938

Death of Margaret Johnson⁴⁵⁴ on 7 March.
 Death of Frances Elizabeth Kennedy³⁴¹ on 10 June, in Saratoga, Carbon, Wyoming, USA.
 Birth of Jack J Kennaday⁴⁶⁹ on 18 September, in Saratoga, Carbon, Wyoming, USA.
 Birth of Alice Ann Kennaday²⁷⁰ in Saratoga, Carbon, Wyoming, USA.

1939

Birth of Mary Elizabeth Kelley⁴⁰¹ on 2 January, in Carlisle, Kentucky, USA.
 Birth of Jack Wayne Kennaday¹³² on 15 December.
 Birth of Nelson Chester Whitman¹⁷⁰ in BigPiney, Sublette, Wyoming, USA.

1940

Birth of Jimmy Ray Lott¹³⁹ on 22 March.
 Death of Harry Otis Kennaday³¹⁹ on 25 April, in Cheyenne, Laramie, Wyoming, USA.
 Death of Mable Pierce³²² on 27 May, in Saratoga, Carbon, Wyoming, USA.
 Death of Charles Alonzo Kennaday³⁴² on 6 December, in Saratoga, Carbon, Wyoming, USA.
 Birth of Carl L Kennaday⁴⁷⁰ on 18 December, in Saratoga, Carbon, Wyoming, USA.
 Birth of Norman Perry Curtis¹⁵³.
 Birth of Boyd David Whitman¹⁷⁴ in BigPiney, Sublette, Wyoming, USA.

1941

Birth of Dorothy Lorraine Cairns²⁹⁴ in Rawlins, Carbon, Wyoming, USA.
 Birth of Richard Ward Whitman¹⁷⁶ in BigPiney, Sublette, Wyoming, USA.

1942

Birth of Gary Forrest Kennaday¹³⁴ on 7 February.
 Birth of Wanda Lou Kelley⁴⁰³ on 22 February, in Carlisle, Kentucky, USA.
 Birth of Joy L Kennaday⁴⁷² on 17 April, in Saratoga, Carbon, Wyoming, USA.
 Birth of Sherry Jean Marier¹⁵⁶ on 22 November.
 Birth of Robert Harry Rogerson¹⁸⁸.
 Death of Dorothy Lorraine Cairns²⁹⁴.

1943

Birth of Ronald David Kelley, Sr.¹⁵⁰ on 10 September, in Pueblo, Colorado, USA.
 Birth of Garrett David Ackerson¹⁹⁸.

1944

Birth of Donald Fay Kennaday⁴⁷⁴ on 18 May, in Saratoga, Carbon, Wyoming, USA.
 Birth of Charlotte Louise Whitman¹⁷⁸ in BigPiney, Sublette, Wyoming, USA.

1945

Birth of Jane Marie Marier¹⁵⁹ on 4 February.
 Birth of Carolyn June Kelley¹⁵² on 8 February, in Carlisle, Kentucky, USA.
 Marriage of Ellen (Dude) Stockwell²⁵⁴ and Forest Jack Kennaday²⁵³ on 9 June.
 Marriage of Lincoln Frank Kennaday²⁶² and Joan Olivia Debernardi²⁶³ on 25 October.
 Birth of Cristine Faye Kelley⁴⁰⁵ on 9 December, in Carlisle, Kentucky, USA.
 Birth of Edward J McCrea¹⁹³.
 Birth of Craig Martin Schmeling²⁹⁶ in Whittemore, Platte, Wyoming, USA.
 Birth of Terry Walter Ackerson²⁰⁰.

1946

Birth of Gary Jo Kennaday¹⁶¹ on 4 March, in Roseburg, Douglas, Oregon, USA.
 Birth of Judy Ann Cairns²⁹⁵ in Rawlins, Carbon, Wyoming, USA.
 Birth of Kay Harding²⁰¹.
 Death of Mary Miranda Unknown⁵⁶².
 Birth of Patricia Cox²⁰².
 Birth of Katheryne Louise Blackburn¹⁹².
 Birth of Marcella Ann Whitman¹⁸⁰.

1947

Birth of Betty Carol Fitzpatrick¹⁵¹ on 14 April, in Paris, Bourbon, Kentucky, USA.
 Birth of Wesley Cecil Ackerson²⁰³.

1948

Marriage of James Martin Marier²⁶¹ and Bonnie Jean Kennaday²⁵⁹ on 6 April.
 Marriage of John David Kelley²⁵⁸ and Iva June Kennaday²⁵⁷ on 8 August, in Flemmingburg, Kentucky, USA.
 Birth of Phillis Lana Whitman¹⁸².
 Birth of Wilma Elaine Rogerson¹⁸⁹.
 Birth of Danny Ray Ackerson²⁰⁵.
 Birth of Evelyn Anderson¹⁹⁹.

1949

Birth of David Debernardi Kennaday¹⁶³ on 8 January, in Roseburg, Douglas, Oregon, USA.
 Birth of Daniel Clark Davidson¹⁹⁶.
 Birth of Ruth Orrine Rogerson¹⁹⁰.

1950

Birth of Linda Ann Cairns²²².
 Birth of Ronald Otis Page²²³ in Colorado Springs, ElPaso, Colorado, USA.
 Birth of Nancy Sue Kurth²⁰⁶.

1951

Birth of Gary Scott³⁷⁰ on 3 January.
 Birth of Brenda Jane Kelley⁴⁰⁸ on 25 August, in Carlisle, Kentucky, USA.
 Death of Edward Thomas Kennaday³²³ on 16 October.
 Birth of Christine Marie Cairns²²⁴ in Rawlins, Carbon, Wyoming, USA.
 Birth of Suellen Louise Davidson²⁰⁷.

1952

Death of Nancy Alice Martindale³³⁶ on 27 August, in Polk, Missouri, USA.
 Birth of Laurel Alice Whitman¹⁸⁴.

1953

Birth of James Luther Kelley, Jr.⁴⁰⁹ on 14 February, in Carlisle, Kentucky, USA.
 Birth of Richard Norman Wilson²³⁴ in Rawlins, Carbon, Wyoming, USA.
 Birth of John Ellery Masters²⁰⁸.
 Birth of Harvey David Blackburn¹⁹⁴.
 Birth of Paula Jo Smith¹⁶⁴ in Roseburg, Douglas, Oregon, USA.
 Death of Robert Harry Rogerson¹⁸⁸.
 Birth of Jack Lavoy Cairns, Jr.²²⁶ in Rock Springs, Sweetwater, Wyoming, USA.

1954

Birth of Bobby Gene Kelley³⁷² on 8 August, in Carlisle, Kentucky, USA.
 Birth of Freddie Warren Kelley⁴¹⁰ on 24 September, in Carlisle, Kentucky, USA.
 Birth of Jean Marie Davidson¹⁹⁷.
 Birth of Elizabeth Kay Cairns²²⁸ in Rawlins, Carbon, Wyoming, USA.
 Birth of John Ellery Cooper²³³ in Yonkers, New York, USA.
 Birth of Kenneth Logan Wilson²³⁵ in Rawlins, Carbon, Wyoming, USA.

1955

Death of Frank Forest Kennaday³²¹ on 11 November.
 Birth of Donnie Lee Kelley⁴¹¹ on 25 November, in Carlisle, Kentucky, USA.
 Birth of Phyllis Ann Wilson²³⁶ in Rawlins, Carbon, Wyoming, USA.
 Birth of William Wayne Cairns²³⁰ in Rawlins, Carbon, Wyoming, USA.
 Birth of Craig Campbell²²⁵.
 Birth of Rebecca Cassler²²⁷.
 Birth of Kristy Lee Ary²⁰⁴.

1956

Birth of Steven Scott Kennaday¹⁶⁵ on 5 March, in Roseburg, Douglas, Oregon, USA.
 Death of James Luther Kelley⁴¹⁹ on 27 March, in Carlisle, Kentucky, USA.
 Death of Freddie Warren Kelley⁴¹⁰ on 4 November, in Carlisle, Kentucky, USA.
 Birth of James Vencent Boyd¹⁹ in Cleveland, Ohio, USA.
 Death of Alice Mannahan³²⁴.
 Birth of Catherine Susan Lavelle¹⁶⁶ in Van Nuys, California, USA.
 Birth of Brigid Ann Young¹⁶⁹ in Burbank, Los Angeles, California, USA.
 Birth of Rebecca Gay Cairns²³² in Rawlins, Carbon, Wyoming, USA.

1957

Birth of Fredrick Frank Kennaday¹⁶⁸ on 5 May, in Roseburg, Douglas, Oregon, USA.
 Birth of Linda Hayes⁶².
 Birth of Kae Porter²³¹ in Ceder City, Iron, Utah, USA.
 Birth of Charles Whitman¹⁸⁷.

1958

Birth of Brenda Sue Sobo¹⁸ on 22 March, in Klamath, Falls, Klamath, Organ, USA.
 Birth of Billy Dean Kelley⁴¹² on 9 June, in Carlisle, Kentucky, USA.
 Marriage of August Henry Geppert¹²⁷ and Patty Ray Kennaday¹²⁶ on 26 July.
 Birth of Delera Kay Lott³⁶ on 8 November.
 Death of John Harvey Sapp⁵⁶¹ on 18 December.
 Death of John W Kennaday⁴⁸¹ on 19 December.
 Birth of Toby Hayes⁶⁵.

1959

Birth of Randy Eugene Sobo²⁰ on 7 July, in Medford, Jackson, Organ, USA.
 Birth of Donna Scott³⁷¹ on 4 August.
 Birth of Rosa e Mary Berryman³⁸² on 26 September.
 Death of Anna Ruth Kennaday³¹⁵ on 6 November, in Ceder Vale, Chautauqua, Kansas, USA.
 Birth of Robbyn Cherter Whitman⁸³.

1960

Birth of Lori Ann Geppert²⁶ on 18 February, in Portland, Washington, Organd, USA.
 Birth of Todd Kennaday³¹ on 5 May, in Oregon.
 Birth of Lee Ann Marie Lott⁴⁰ in August.
 Birth of Teresa Lynn Sobo²² on 19 August, in Medford, Jackson, Organ, USA.
 Birth of John Frank Lott⁴⁴ on 23 September.
 Death of Anne E D Kennaday⁴⁸² on 4 October.
 Death of Anna Marshal⁴⁸⁵ on 8 December, in Saratoga, Carbon, Wyoming, USA.
 Birth of Kathy Ann Lott³⁷ on 12 December.
 Birth of Peri Ann Whitman⁸⁴.
 Birth of Charles Noller Davidson²¹².
 Marriage of Thomas Eugene Kennaday¹²⁴ and Janice Benson¹²⁵ in Antonio, Texas.
 Birth of Gerald Noller Tomayer²¹¹.

1961

Death of Mary Elizabeth Minton⁴³⁰ on 26 January, in Carlisle, Kentucky, USA.
 Birth of Gilbert Berryman³⁸³ on 20 April.
 Birth of Karla Lynn Kennaday²⁴ on 8 July, in Vallejo, Napa, California, USA.
 Death of Charles Fredrick Kennaday³²⁷ on 6 December.
 Marriage of John Jennings⁴⁷³ and Joy L Kennaday⁴⁷².

1962

Birth of Julie Mae Berryman³⁸⁴ on 2 June.
 Birth of Calvin E Terett Lott⁴¹ in July.
 Birth of Gordon Scott (Scotty) Johnson⁷⁸ on 10 August.
 Birth of Randy Eugene Lott¹⁴⁹ on 29 December.
 Birth of Marcus Pine Whitman⁴⁶¹.
 Birth of Marcus Pine Whitman⁸⁵.
 Birth of Lorraine Madden¹⁷³.
 Birth of Joyce Ellen Jorgensen³² in Phoenix, Orange, Arizona, USA.
 Birth of Richard Lee Wells²¹⁵.
 Birth of Kathy Kay Kennaday²⁵ in Vallejo, Napa, California, USA.
 Birth of Judy Arlene Geppert²⁸ in Portland, Washington, Organd, USA.
 Birth of Karen Hayes⁶⁷.

1963

Marriage of Norman Perry Curtis¹⁵³ and Carolyn June Kelley¹⁵² on 12 January, in Carlisle, Kentucky, USA.
 Marriage of Ronald David Kelley, Sr.¹⁵⁰ and Betty Carol Fitzpatrick¹⁵¹ on 6 April, in Carlisle, Kentucky, USA.
 Death of Julie Mae Berryman³⁸⁴ on 3 September.
 Birth of Diana Lott⁴⁵ on 13 September.
 Birth of Freda Jean Berryman³⁸⁵ on 14 September.
 Birth of Lisa June Kelley⁵⁰ on 18 December, in Carlisle, Kentucky, USA.
 Birth of Tori Dawn Bartlett⁹¹.
 Birth of Celeste Marie Hoffman¹⁹⁵.
 Birth of Keren Lynne Harned²¹⁴.

1964

Birth of Darren Kennaday³³ on 19 February.
 Birth of Anita Carol Curtis⁵⁷ on 9 April, in ICarlisle, Nichlos, Kentucky, USA.
 Birth of MAnnett Marie Lott³⁸ on 4 June.
 Birth of Tommy Berryman, II³⁸⁶ on 3 September.
 Birth of Anna Carol Kelley⁵³ on 27 November.

1964 (continued)

Birth of Tommy Duane Geppert³⁰ in Portland, Washington, Oregon, USA.

1965

Birth of Stanley (Stan) Johnson⁷⁹ on 14 June.

Birth of Katy Sue Blunt⁴² on 21 June.

Birth of Kelly Michele Kennaday³⁴ on 9 July.

Death of Wilma Elaine Rogerson¹⁸⁹.

Birth of Kathleen Marie Redman²¹⁶.

1966

Birth of Mike Allen Forrester, Jr.⁸⁰ on 22 January.

Birth of Roxy Ann Lott³⁹ on 24 January.

Birth of Ronald David Kelley, Jr.⁵⁶ on 9 June, in Lexington, Kentucky, USA.

Birth of Norman Perry Curtis, Jr.⁶³ on 28 August, in Indianapolis, Marion, Indiana, USA.

Birth of Bradly Tommy Thompson⁹⁴.

1967

Birth of Michele Lott⁴⁶ in June.

Birth of Jeffrey Michael Kennaday³⁵ on 26 September.

Death of Fairfax Harry Davidson³²⁶.

Birth of Fred Winton Smith⁹⁵.

Birth of Grant Douglas Whitman⁸⁹.

1968

Birth of Tommy James Forrester⁸¹ on 4 May.

Birth of Gail Robin Whitman⁹⁰.

Birth of Micheal Gerald Sturm Whitman⁸⁶.

Death of Logan Turner Cairns³³⁰.

1969

Birth of Patrick Keith Whitman⁸⁷.

Birth of Collin Wade Whitman⁹⁶.

Birth of Travis Darryl Bartlett⁹².

1970

Birth of Melony Jo Curtis⁶⁶ on 14 January, in Indianapolis, Marion, Indiana, USA.

Death of John David Kelley²⁵⁸ on 12 April, in Carlisle, Kentucky, USA.

Death of Melony Jo Curtis⁶⁶ on 8 December, in Indianapolis, Marion, Indiana, USA.

Birth of Kathryn Victoria Redman²²⁰.

1971

Birth of Thomas Elliott Page¹⁰⁰ in Ogden, Weber, Utah, USA.

1972

Death of Mary Lou Kennaday²⁶⁶.

1973

Birth of David Earl Curtis⁶⁸ on 17 April, in Indianapolis, Marion, Indiana, USA.

Birth of Johnathan Jack Page¹⁰¹ in Rawlins, Carbon, Wyoming, USA.

Birth of Nathanielle Rebecca Whitman⁸⁸.

1974

Death of Fay Kennaday⁴⁷⁷ on 23 May.

Birth of Trevor David Bartlett⁹³.

Marriage of Carl L Kennaday⁴⁷⁰ and Carol Brugus⁴⁷¹.

Birth of Stuart Branson Self⁹⁷.

Birth of Ronnie Wesley Redman²²¹.

1975

Birth of Jeremy Alan Hansen¹⁰⁸ in Craig, Moffat, Colorado, USA.

Birth of Kreetta Ann Jebens¹¹⁹ in Rawlins, Carbon, Wyoming, USA.

Birth of Ian Mathew Self⁹⁸.

Birth of Donald Grant Page¹⁰² in Rawlins, Carbon, Wyoming, USA.

1976

Birth of Aaron Wayne Hansen¹⁰⁹ in Idaho Falls, Bonneville, Idaho, USA.

Birth of Tyler Martin Schmeling²³⁸ in Wheatland, Platte, Wyoming, USA.

1977

Birth of Korey Kay Jebens¹²⁰ in Rawlins, Carbon, Wyoming, USA.

Birth of Tiffany Anne Cooper¹¹⁶ in Logan, Cache, Utah, USA.

Birth of Ashley Chester Self⁹⁹.

Birth of Steve Hix¹¹⁷.

1978

Birth of Amy Nichole Schmelting²³⁹ in Cheyenne, Laramie, Wyoming, USA.
 Birth of Triana Marie Campbell¹⁰³ in Salt Lake City, Salt Lake, Utah, USA.
 Birth of Nicholas Isaiah Kennaday⁷⁰ in Roseburg, Douglas, Oregon, USA.
 Birth of Hillary Ranee Cooper¹¹⁸ in Logan, Cache, Utah, USA.

1979

Death of Alice Oda May Kennaday³²⁵ on 6 December, in Rawlins, Carbon, Wyoming, USA.
 Birth of Carlie Norman Jebens¹²¹ in Rawlins, Carbon, Wyoming, USA.
 Birth of Michael Brent Hansen¹¹⁰ in Idaho Falls, Bonneville, Idaho, USA.
 Birth of Patricia Leigh Kennaday⁷⁶ in San Diego, San Diego, California, USA.
 Birth of Rachel Elizabeth Cairns¹⁰⁶.

1980

Birth of Clarence Bland Kennedy³¹⁰ on 9 April, in Ceder Vale, Chautauqua, Kansas, USA.
 Birth of Holly Ann Campbell¹⁰⁴ in Salt Lake City, Salt Lake, Utah, USA.
 Birth of Elizabeth Alta Olivia Kennaday⁷¹ in Roseburg, Douglas, Oregon, USA.

1981

Birth of Amy Nicole Hansen¹¹¹ in Idaho Falls, Bonneville, Idaho, USA.
 Birth of Anthony Joseph Kennaday⁷⁷ in Roseburg, Douglas, Oregon, USA.

1982

Birth of Justin Kyle Sobo³ in Medford, Jackson, Organ, USA.
 Birth of Cristina Dianne Kennaday⁷² in Roseburg, Douglas, Oregon, USA.
 Birth of Joshua Jolin Kennaday⁷³ in Glide, Douglas, Oregon, USA.

1983

Birth of Christian David Hunnicutt⁹ on 10 January, in Indianapolis, Indiana, USA.
 Death of Loyd Andrew Kennaday⁴⁷⁵ on 10 December.
 Birth of Mary Melissa Cairns¹⁰⁷.
 Birth of Dorci Kae Cairns¹¹³ in Idaho Falls, Bonneville, Idaho, USA.
 Birth of Jacob Karl Hansen¹¹² in Idaho Falls, Bonneville, Idaho, USA.

1985

Birth of Julie Erin Sobo⁴ in Medford, Jackson, Organ, USA.
 Birth of Eric Raymond Campbell¹⁰⁵ in Salt Lake City, Salt Lake, Utah, USA.
 Death of Alice Ann Kennaday²⁷⁰.

1987

Birth of Adam Malaki Kennaday⁷ in Anaheim, Orange, Calaforina, USA.
 Birth of Tyler Jamison Sobo⁶ in Medford, Jackson, Organ, USA.
 Birth of Travis Andrew Sobo⁵ in Medford, Jackson, Organ, USA.

1988

Death of Emma Helen Kennaday³²⁹ on 26 August, in Rawlins, Carbon, Wyoming, USA.
 Birth of Jace William Cairns¹¹⁴ in Idaho Falls, Bonneville, Idaho, USA.

1990

Birth of Aaron Forest Kennaday⁸ in Anaheim, Orange, Calaforina, USA.
 Death of Gladys Eleanor Ream²⁴⁹.

1991

Birth of James Mathew Asbury¹⁰ on 28 June, in Lexington, Kentucky, USA.
 Death of Inez Henderson⁴⁷⁶ on 22 September, in Saratoga, Carbon, Wyoming, USA.
 Birth of Brindi Michelle Cairns¹¹⁵ in Idaho Falls, Bonneville, Idaho, USA.

1992

Birth of Caitlin Arlena Boyd¹ in Manaqua, Nicaraqua.

1993

Death of Carolyn June Kelley¹⁵² on 23 August.

1994

Birth of Mercedes Curtis¹⁵ in August, in Indianapolis, Marion, Indiana, USA.
 Birth of Jason Alexander Boyd².

1995

Birth of Savanna June Curtis¹⁶ on 14 June, in Indianapolis, Marion, Indiana, USA.
 Death of Carlie Norman Jebens¹²¹.

1996

Marriage of David Earl Curtis⁶⁸ and Toni Benner⁶⁹ on 7 July.
 Birth of Ivie Ski Curtis¹⁷ on 11 November.
 Death of Charles Leroy Stewart²⁴⁶.

1997

Death of Ronald David Kelley, Jr.⁵⁶ on 15 September, in Indianapolis, Marion, Indiana, USA.

1999

Death of James Martin Marier²⁶¹.

2005

Death of Iva June Kennaday²⁵⁷ on 16 March, in Indianapolis, Indiana, USA.

18. INDEX OF INDIVIDUALS

<u>Ref.</u>	<u>Tree</u>	<u>Name (Relationship)</u>
424		WATKINS, Efrfie Mae (John David Kelley's cousin).
435	 Mr. (John David Kelley's uncle by marriage).
205	55	ACKERSON, Danny Ray (William's four-times-great-grandson).
198	55 Garrett David (William's four-times-great-grandson).
200	55 Terry Walter (William's four-times-great-grandson).
282	55 Walter Cecil (William's great-great-great-granddaughter's husband).
203	55 Wesley Cecil (William's four-times-great-grandson).
199		ANDERSON, Evelyn (William's four-times-great-grandson's wife).
514	 Mattie (Charles Alonzo Kennaday's aunt by marriage).
547		ANKROM, Clementine (Sarah Ann Ankrom's sister).
545	 Elizabeth (Sarah Ann Ankrom's sister).
549	 John (Sarah Ann Ankrom's father).
540	 John Ellery (Sarah Ann Ankrom's brother).
553	 Joseph (Sarah Ann Ankrom's grandfather).
542	 Martha Ann (Sarah Ann Ankrom's sister).
541	 Mary Ann (Sarah Ann Ankrom's sister).
546	 Miriah (Sarah Ann Ankrom's sister).
538	 Richard (Sarah Ann Ankrom's brother).
357	72 Sarah Ann (William's grandson's wife).
539	 Solomon (Sarah Ann Ankrom's brother).
548	 Thomas (Sarah Ann Ankrom's brother).
544	 Uriah (Sarah Ann Ankrom's brother).
551	 William (Sarah Ann Ankrom's grandfather).
543	 William (Sarah Ann Ankrom's brother).
204		ARY, Kristy Lee (William's four-times-great-grandson's wife).
10	5	ASBURY, James Mathew (William's six-times-great-grandson).
52	5 James Mickel (William's five-times-great-granddaughter's husband).
11	5 Liam Joseph (William's six-times-great-grandson).
338		BACUS, Effie (William's great-grandson's wife).
179	32	BARTLETT, Joseph Grant (William's four-times-great-granddaughter's husband).
91	32 Tori Dawn (William's five-times-great-granddaughter).
92	32 Travis Darryl (William's five-times-great-grandson).
93	32 Trevor David (William's five-times-great-grandson).
328	67	BAYS, Margaret (William's great-great-grandson's wife).
69	7	BENNER, Toni (William's five-times-great-grandson's wife).
125	9	BENSON, Janice (William's four-times-great-grandson's wife).
385		BERRYMAN, Freda Jean (John David Kelley's great-niece).
383	 Gilbert (John David Kelley's great-nephew).
384	 Julie Mae (John David Kelley's great-niece).
382	 Rosa e Mary (John David Kelley's great-niece).
404	 Tommy (John David Kelley's niece's husband).
386	 Tommy, II (John David Kelley's great-nephew).
278	53	BLACKBURN, Harvey Alton (William's great-great-great-granddaughter's husband).
194	53 Harvey David (William's four-times-great-grandson).
192	53 Kathyryne Louise (William's four-times-great-granddaughter).
142	17	BLUNT, Al (William's four-times-great-granddaughter's husband).
43	17 Ed (William's five-times-great-grandson).
42	17 Katy Sue (William's five-times-great-granddaughter).
533		BOICE, Ephriam (Charles Alonzo Kennaday's great-grandfather).
523	 Jacob (Charles Alonzo Kennaday's great-uncle).
521	 Katie (Charles Alonzo Kennaday's great-aunt).
519	 Mary B (Charles Alonzo Kennaday's great-aunt).
518	 Rebecca K (Charles Alonzo Kennaday's grandmother).
452		BOWLES, Pamela Frances (John David Kelley's grandmother).
1	1	BOYD, Caitlin Arlena (William's six-times-great-granddaughter).
19	1 James Vencent (William's five-times-great-granddaughter's husband).
2	1 Jason Alexander (William's six-times-great-grandson).
133	13	BRANT, Carol Lee (William's four-times-great-grandson's wife).
251		BRAY, Mr. (William's great-great-great-granddaughter's husband).
471		BRUGUS, Carol (Charles Alonzo Kennaday's great-nephew's wife).
115	40	CAIRNS, Brindi Michelle (William's five-times-great-granddaughter).
224	59 Christine Marie (William's four-times-great-granddaughter).

<u>Ref.</u>	<u>Tree</u>	<u>Name (Relationship)</u>
113	40	CAIRNS, Dorci Kae (William's five-times-great-granddaughter).
294	68 Dorothy Lorraine (William's great-great-great-granddaughter).
275	 Douglas Turner (William's great-great-great-granddaughter's husband).
228	59 Elizabeth Kay (William's four-times-great-granddaughter).
114	40 Jace William (William's five-times-great-grandson).
290	68 Jack Lavoy (William's great-great-great-grandson).
226	59 Jack Lavoy, Jr. (William's four-times-great-grandson).
295	68 Judy Ann (William's great-great-great-granddaughter).
222	59 Linda Ann (William's four-times-great-granddaughter).
330	68 Logan Turner (William's great-great-granddaughter's husband).
292	68 Margaret Faunita (William's great-great-great-granddaughter).
107	38 Mary Melissa (William's five-times-great-granddaughter).
106	38 Rachel Elizabeth (William's five-times-great-granddaughter).
232	59 Rebecca Gay (William's four-times-great-granddaughter).
230	59 William Wayne (William's four-times-great-grandson).
225	37	CAMPBELL, Craig (William's four-times-great-granddaughter's husband).
105	37 Eric Raymond (William's five-times-great-grandson).
104	37 Holly Ann (William's five-times-great-granddaughter).
103	37 Triana Marie (William's five-times-great-granddaughter).
227	38	CASSLER, Rebecca (William's four-times-great-grandson's wife).
497		CATTERSON, Sarah (Charles Alonzo Kennaday's aunt by marriage).
191		CAYLOR, Roger (William's four-times-great-granddaughter's husband).
23		CLARIDGE, Tom (William's five-times-great-granddaughter's husband).
135		COMPTON, Vicki (William's four-times-great-grandson's wife).
118	41	COOPER, Hillary Rane (William's five-times-great-granddaughter).
233	41 John Ellery (William's four-times-great-granddaughter's husband).
116	41 Tiffany Anne (William's five-times-great-granddaughter).
172	29	CORLETT, Claudette Irene (William's four-times-great-grandson's wife).
462	 Claudette Irene (Bruce Douglas Whitman's wife).
186	 Everett Michael (William's four-times-great-granddaughter's husband).
407		COX, Mr. (John David Kelley's niece's husband).
202	 Patricia (William's four-times-great-grandson's wife).
57	21	CURTIS, Anita Carol (William's five-times-great-granddaughter).
68	21 David Earl (William's five-times-great-grandson).
17	7 Ivie Ski (William's six-times-great-granddaughter).
66	21 Melony Jo (William's five-times-great-granddaughter).
15	7 Mercedes (William's six-times-great-granddaughter).
153	21 Norman Perry (William's four-times-great-granddaughter's husband).
63	21 Norman Perry, Jr. (William's five-times-great-grandson).
16	7 Savanna June (William's six-times-great-granddaughter).
280	54	DADISMAN, Norma Hilda (William's great-great-great-grandson's wife).
283	66	DAVIDSON, Charles Daniel (William's great-great-great-grandson).
212	56 Charles Noller (William's four-times-great-grandson).
279	66 Chester Clark (William's great-great-great-grandson).
196	54 Daniel Clark (William's four-times-great-grandson).
209	56 Deborah Jeane (William's four-times-great-granddaughter).
281	66 Eleanora Alice (William's great-great-great-granddaughter).
326	66 Fairfax Harry (William's great-great-granddaughter's husband).
271	66 Frances Amonda (William's great-great-great-granddaughter).
197	54 Jean Marie (William's four-times-great-granddaughter).
277	66 Louize Gertrude (William's great-great-great-granddaughter).
285	66 Myrtle Rae (William's great-great-great-granddaughter).
207	56 Suellen Louise (William's four-times-great-granddaughter).
273	66 Vita Maude (William's great-great-great-granddaughter).
263	50	DEBERNARDI, Joan Olivia (William's great-great-great-grandson's wife).
508		DIEHL, Noah (Charles Alonzo Kennaday's uncle by marriage).
140	16	DOLLAR HYDE, Ellen (William's four-times-great-grandson's wife).
552		EAGOR, Mary (Sarah Ann Ankrom's grandmother).
422		EARLYWINE, Betty (John David Kelley's sister-in-law).
218		FERRIN, Richard (William's four-times-great-granddaughter's husband).
151	20	FITZPATRICK, Betty Carol (William's four-times-great-grandson's wife).
368	 Pete Fitzpatrick (Betty Carol Fitzpatrick's father).

<u>Ref.</u>	<u>Tree</u>	<u>Name (Relationship)</u>
82	23	FORRESTER, Jamie (William's five-times-great-granddaughter).
160	23 Micheal A (William's four-times-great-granddaughter's husband).
80	23 Mike Allen, Jr. (William's five-times-great-grandson).
81	23 Tommy James (William's five-times-great-grandson).
127	10	GEPPERT, August Henry (William's four-times-great-granddaughter's husband).
28	10 Judy Arlene (William's five-times-great-granddaughter).
26	10 Lori Ann (William's five-times-great-granddaughter).
30	10 Tommy Duane (William's five-times-great-grandson).
369		GULETT, Virginia Ruth (Betty Carol Fitzpatrick's mother).
109	39	HANSEN, Aaron Wayne (William's five-times-great-grandson).
229	39 Alan (William's four-times-great-granddaughter's husband).
111	39 Amy Nicole (William's five-times-great-granddaughter).
112	39 Jacob Karl (William's five-times-great-grandson).
108	39 Jeremy Alan (William's five-times-great-grandson).
110	39 Michael Brent (William's five-times-great-grandson).
201		HARDING, Kay (William's four-times-great-grandson's wife).
286	57	HARNED, David Debernardi (William's great-great-great-granddaughter's husband).
214	57 Keren Lynne (William's four-times-great-granddaughter).
58	12	HAYES, Bob (William's five-times-great-grandson).
131	12 Bob (William's four-times-great-granddaughter's husband).
67	12 Karen (William's five-times-great-granddaughter).
62	12 Linda (William's five-times-great-granddaughter).
65	12 Toby (William's five-times-great-grandson).
476		HENDERSON, Inez (Charles Alonzo Kennaday's nephew's wife).
503		HEWITT, William B (Charles Alonzo Kennaday's uncle by marriage).
117		HIX, Steve (William's five-times-great-granddaughter's husband).
195		HOFFMAN, Celeste Marie (William's four-times-great-grandson's wife).
129	11	HUBBARD, Rosa L (William's four-times-great-grandson's wife).
516		HUDSON, Sarah (Charles Alonzo Kennaday's grandmother).
9	4	HUNNICUTT, Christian David (William's six-times-great-grandson).
51	4 Cristian (William's five-times-great-granddaughter's husband).
359		JARVIS, Lydia (William's grandson's wife).
237	42	JEBENS, Carlie (William's four-times-great-granddaughter's husband).
121	42 Carlie Norman (William's five-times-great-grandson).
120	42 Korey Kay (William's five-times-great-granddaughter).
119	42 Kreetta Ann (William's five-times-great-granddaughter).
213		JENKINS, Tonia (William's four-times-great-grandson's wife).
473		JENNINGS, John (Charles Alonzo Kennaday's great-niece's husband).
291	59	JOHNSON, Beverly Ann (William's great-great-great-grandson's wife).
260	48 Gordon (William's great-great-great-granddaughter's husband).
158	22 Gordon (William's four-times-great-granddaughter's husband).
78	22 Gordon Scott (Scotty) (William's five-times-great-grandson).
21	2 Kim Eileen (William's five-times-great-grandson's wife).
454	 Margaret (John David Kelley's grandmother).
155	48 Scott (William's four-times-great-grandson).
154	48 Stanley (William's four-times-great-grandson).
79	22 Stanley (Stan) (William's five-times-great-grandson).
217	 Timothy Tol (William's four-times-great-granddaughter's husband).
32	3	JORGENSEN, Joyce Ellen (William's five-times-great-grandson's wife).
177	31	JOUETT, Robin Knipp (William's four-times-great-grandson's wife).
392		KELLEY, Amanda (John David Kelley's great-niece).
53	20 Anna Carol (William's five-times-great-granddaughter).
416	 Aquilla David (John David Kelley's nephew).
423	 Aquilla Durham (John David Kelley's brother).
436	 Betty Jane (John David Kelley's aunt).
418	 Beverly (John David Kelley's niece).
393	 Billy Dean (John David Kelley's great-nephew).
412	 Billy Dean (John David Kelley's nephew).
372	 Bobby Gene (John David Kelley's great-nephew).
408	 Brenda Jane (John David Kelley's niece).
152	47 Carolyn June (William's four-times-great-granddaughter).
405	 Cristine Faye (John David Kelley's niece).

<u>Ref.</u>	<u>Tree</u>	<u>Name (Relationship)</u>
411		KELLEY, Donnie Lee (John David Kelley's nephew).
394	 Dorthy Mae (John David Kelley's niece).
459	 Edward (John David Kelley's great-great-great-grandfather).
457	 Erasmus E (John David Kelley's great-great-grandfather).
396	 Eugene (John David Kelley's nephew).
410	 Freddie Warren (John David Kelley's nephew).
432	 Herbert (John David Kelley's uncle).
433	 Herman (John David Kelley's uncle).
419	 James Luther (John David Kelley's brother).
409	 James Luther, Jr. (John David Kelley's nephew).
258	47 John David (William's great-great-great-granddaughter's husband).
398	 Juanita (John David Kelley's niece).
451	 Lewis (John David Kelley's grandfather).
50	20 Lisa June (William's five-times-great-granddaughter).
563	 Lou (Betty Earlywine's mother).
434	 Mabel (John David Kelley's aunt).
401	 Mary Elizabeth (John David Kelley's niece).
417	 Mary Lou (John David Kelley's niece).
415	 Mildred Ann (John David Kelley's niece).
431	 Milton Varso (John David Kelley's uncle).
56	20 Ronald David, Jr. (William's five-times-great-grandson).
150	47 Ronald David, Sr. (William's four-times-great-grandson).
437	 Silverine (John David Kelley's aunt).
429	 Talmadge Blane (John David Kelley's father).
421	 Talmadge Blane, Jr. (John David Kelley's brother).
403	 Wanda Lou (John David Kelley's niece).
414	 William Blaine (John David Kelley's nephew).
455	 William S (John David Kelley's great-grandfather).
8	3	KENNADAY, Aaron Forest (William's six-times-great-grandson).
7	3 Adam Malaki (William's six-times-great-grandson).
494	 Alice (Charles Alonzo Kennaday's aunt).
270	65 Alice Ann (William's great-great-great-granddaughter).
325	71 Alice Oda May (William's great-great-granddaughter).
317	71 Alonso (William's great-great-grandson).
484	 Andrew Jackson (Charles Alonzo Kennaday's brother).
315	71 Anna Ruth (William's great-great-granddaughter).
482	 Anne E D (Charles Alonzo Kennaday's sister).
77	27 Anthony Joseph (William's five-times-great-grandson).
493	 Axie (Charles Alonzo Kennaday's aunt).
259	64 Bonnie Jean (William's great-great-great-granddaughter).
470	 Carl L (Charles Alonzo Kennaday's great-nephew).
267	65 Catherine Marie (William's great-great-great-granddaughter).
342	71 Charles Alonzo (William's great-great-granddaughter's husband).
327	71 Charles Fredrick (William's great-great-grandson).
122	43 Charlotte Arlene (William's four-times-great-granddaughter).
72	24 Cristina Dianne (William's five-times-great-granddaughter).
33	13 Darren (William's five-times-great-grandson).
163	50 David Debernardi (William's four-times-great-grandson).
474	 Donald Fay (Charles Alonzo Kennaday's great-nephew).
323	71 Edward Thomas (William's great-great-grandson).
71	24 Elizabeth Alta Olivia (William's five-times-great-granddaughter).
483	 Emma H (Charles Alonzo Kennaday's sister).
329	71 Emma Helen (William's great-great-granddaughter).
477	 Fay (Charles Alonzo Kennaday's niece).
250	64 Florence Mae (William's great-great-great-granddaughter).
253	64 Forest Jack (William's great-great-great-grandson).
288	67 Frances Ann (William's great-great-great-granddaughter).
321	71 Frank Forest (William's great-great-grandson).
268	65 Fred E (William's great-great-great-grandson).
168	50 Fredrick Frank (William's four-times-great-grandson).
134	45 Gary Forrest (William's four-times-great-grandson).
161	50 Gary Jo (William's four-times-great-grandson).

<u>Ref.</u>	<u>Tree</u>	<u>Name (Relationship)</u>
319	71	KENNADAY, Harry Otis (William's great-great-grandson).
318	71 Henry George (William's great-great-grandson).
479	 Ida Jane (Charles Alonzo Kennaday's sister).
257	64 Iva June (William's great-great-great-granddaughter).
469	 Jack J (Charles Alonzo Kennaday's great-nephew).
132	45 Jack Wayne (William's four-times-great-grandson).
515	 James (Charles Alonzo Kennaday's grandfather).
269	65 James (William's great-great-great-grandson).
478	 James Edward (Charles Alonzo Kennaday's brother).
35	15 Jeffrey Michael (William's five-times-great-grandson).
265	65 John E (William's great-great-great-grandson).
486	 John Hudson (Charles Alonzo Kennaday's father).
481	 John W (Charles Alonzo Kennaday's brother).
489	 Joseph Bryson (Charles Alonzo Kennaday's uncle).
495	 Joseph Wright (Charles Alonzo Kennaday's uncle).
73	25 Joshua Jolin (William's five-times-great-grandson).
472	 Joy L (Charles Alonzo Kennaday's great-niece).
24	9 Karla Lynn (William's five-times-great-granddaughter).
25	9 Kathy Kay (William's five-times-great-granddaughter).
34	14 Kelly Michele (William's five-times-great-granddaughter).
262	64 Lincoln Frank (William's great-great-great-grandson).
475	 Loyd Andrew (Charles Alonzo Kennaday's nephew).
74	26 Mallory (William's five-times-great-granddaughter).
266	65 Mary Lou (William's great-great-great-granddaughter).
480	 Mary V (Charles Alonzo Kennaday's sister).
491	 Mary Vicker (Charles Alonzo Kennaday's aunt).
137	45 Michael Joseph (William's four-times-great-grandson).
70	24 Nicholas Isaiah (William's five-times-great-grandson).
76	27 Patricia Leigh (William's five-times-great-granddaughter).
126	43 Patty Ray (William's four-times-great-granddaughter).
492	 Rachel A (Charles Alonzo Kennaday's aunt).
75	26 Reed (William's five-times-great-grandson).
313	71 Rosa Marie (William's great-great-granddaughter).
255	64 Rose Marie (William's great-great-great-granddaughter).
312	71 Sarah Elizabeth (William's great-great-granddaughter).
165	50 Steven Scott (William's four-times-great-grandson).
248	64 Thomas Earl (William's great-great-great-grandson).
124	43 Thomas Eugene (William's four-times-great-grandson).
31	13 Todd (William's five-times-great-grandson).
264	65 William C (William's great-great-great-grandson).
490	 Zarilda (Charles Alonzo Kennaday's aunt).
302	69	KENNEDY, Addie (William's great-great-granddaughter).
299	69 Alvin (William's great-great-grandson).
337	72 Andrew (William's great-grandson).
300	69 Bearthey (William's great-great-grandson).
352	73 Christine (William's granddaughter).
310	70 Clarence Bland (William's great-great-grandson).
298	69 Eddie (William's great-great-grandson).
363	73 Elizabeth (William's granddaughter).
331	72 Emaline (William's great-granddaughter).
360	73 Emiline (William's granddaughter).
341	72 Frances Elizabeth (William's great-granddaughter).
305	70 Fredrick Fay (William's great-great-grandson).
346	72 George Washington (William's great-grandson).
353	73 Jacob (William's grandson).
343	72 James Franklin (William's great-grandson).
354	73 James Leighton (William's grandson).
303	70 Jesse Rufus (William's great-great-grandson).
356	73 Jesse Rufus (William's grandson).
365	73 John (William's son).
335	72 John Ronnie (William's great-grandson).
358	73 Jonn (William's grandson).

<u>Ref.</u>	<u>Tree</u>	<u>Name (Relationship)</u>
308	70	KENNEDY, Lillie Irene (William's great-great-granddaughter).
297	69 Marcy (William's great-great-granddaughter).
332	72 Mariah (William's great-granddaughter).
334	72 Nanch Isabell (William's great-granddaughter).
350	73 Nancy (William's granddaughter).
364	73 Rebecca (William's granddaughter).
306	70 Sadie Bell (William's great-great-granddaughter).
361	73 Samuel (William's grandson).
339	72 Samuel Rufus (William's great-grandson).
348	72 Sarah Jane (William's great-granddaughter).
362	73 Sarah Jane (William's granddaughter).
301	69 Willber (William's great-great-grandson).
367	73 William (The subject of this report).
345	72 William Edson (William's great-grandson).
206		KURTH, Nancy Sue (William's four-times-great-grandson's wife).
468		LAMBS- COBB, Mary Adele (Mable Pierce's mother).
166	25	LAVELLE, Catherine Susan (William's four-times-great-grandson's wife).
14	6	LETT, Cory (William's six-times-great-grandson).
13	6 Sara (William's six-times-great-granddaughter).
12	6 Tim (William's six-times-great-grandson).
59	6 Tim (William's five-times-great-granddaughter's husband).
256	46	LOTT, Calvin (William's great-great-great-granddaughter's husband).
41	17 Calvin E Terett (William's five-times-great-grandson).
143	46 Calvin Jay (William's four-times-great-grandson).
36	16 Delera Kay (William's five-times-great-granddaughter).
45	18 Diana (William's five-times-great-granddaughter).
139	46 Jimmy Ray (William's four-times-great-grandson).
148	46 John (William's four-times-great-grandson).
44	18 John Frank (William's five-times-great-grandson).
37	16 Kathy Ann (William's five-times-great-granddaughter).
40	17 Lee Ann Marie (William's five-times-great-granddaughter).
38	16 MAnnett Marie (William's five-times-great-granddaughter).
145	46 Mable Bea (William's four-times-great-granddaughter).
46	18 Michele (William's five-times-great-granddaughter).
149	46 Randy Eugene (William's four-times-great-grandson).
141	46 Rosa Lee (William's four-times-great-granddaughter).
39	16 Roxy Ann (William's five-times-great-granddaughter).
289		LUCAS, Thomas Dean (William's great-great-great-granddaughter's husband).
463		MADDEN, Lorraine (Bruce Douglas Whitman's wife).
173	 Lorraine (William's four-times-great-grandson's wife).
324	65	MANNAHAN, Alice (William's great-great-grandson's wife).
261	49	MARIER, James Martin (William's great-great-great-granddaughter's husband).
159	49 Jane Marie (William's four-times-great-granddaughter).
156	49 Sherry Jean (William's four-times-great-granddaughter).
485		MARSHEL, Anna (Charles Alonzo Kennaday's sister-in-law).
336	70	MARTINDALE, Nancy Alice (William's great-grandson's wife).
208		MASTERS, John Ellery (William's four-times-great-granddaughter's husband).
499		MATOOX, Sallie (Charles Alonzo Kennaday's aunt by marriage).
458		MC IWOAN, Mary (John David Kelley's great-great-grandmother).
438		MC RUTHER, Tonm (John David Kelley's uncle by marriage).
304		MCCLURE, Fay (William's great-great-grandson's wife).
307	 Jay (William's great-great-granddaughter's husband).
193		MCCREA, Edward J (William's four-times-great-granddaughter's husband).
444		MINTON, Carrie (John David Kelley's aunt).
439	 Della (John David Kelley's aunt).
450	 Ethel (John David Kelley's aunt).
441	 Ida Catherine (John David Kelley's aunt).
440	 Isabell May (John David Kelley's aunt).
442	 James (John David Kelley's uncle).
453	 James M (John David Kelley's grandfather).
443	 Maggie (John David Kelley's aunt).
430	 Mary Elizabeth (John David Kelley's mother).

<u>Ref.</u>	<u>Tree</u>	<u>Name (Relationship)</u>
447		MINTON, Phillys (John David Kelley's aunt).
446	 Rosayella (John David Kelley's aunt).
449	 Walter (John David Kelley's uncle).
513		MITCHELL, Annie E (Charles Alonzo Kennaday's aunt by marriage).
460		MULL, America (John David Kelley's great-great-grandmother).
400		MYERS, Mr. (John David Kelley's niece's husband).
210		NATION, Charles William, Jr. (William's four-times-great-granddaughter's husband).
284	56	NOLLER, Earlene Dee (William's great-great-great-grandson's wife).
102	36	PAGE, Donald Grant (William's five-times-great-grandson).
101	36 Johnathan Jack (William's five-times-great-grandson).
223	36 Ronald Otis (William's four-times-great-granddaughter's husband).
100	36 Thomas Elliott (William's five-times-great-grandson).
147		PATCHINS, Lawrence P (William's four-times-great-granddaughter's husband).
464		PEARCE, Alice (Mable Pierce's sister).
466	 Thomas Earl (Mable Pierce's father).
171	28	PENDERGRASS, Cecelia Kay (William's four-times-great-grandson's wife).
309		PERRY, Elmer (William's great-great-granddaughter's husband).
314	62	PETERS, Fred (William's great-great-granddaughter's husband).
240	62 Grace (William's great-great-great-granddaughter).
241	62 John (William's great-great-great-grandson).
60		PHELPS, Mike (William's five-times-great-granddaughter's husband).
467		PHIPPS, James (Mable Pierce's mother's husband).
465	 Virgie (Mable Pierce's half-sister).
322	64	PIERCE, Mable (William's great-great-grandson's wife).
505		POLLARD, John Benjamin (Charles Alonzo Kennaday's uncle by marriage).
231	40	PORTER, Kae (William's four-times-great-grandson's wife).
381		PRUITT, Allen Todd (John David Kelley's great-nephew).
379	 Cristine Mae (John David Kelley's great-niece).
377	 Danny James (John David Kelley's great-nephew).
402	 Harold Lee (John David Kelley's niece's husband).
376	 Haroled Lee, Jr. (John David Kelley's great-nephew).
380	 Michael Cameron (John David Kelley's great-nephew).
378	 Ruth Ann (John David Kelley's great-nephew).
49	11	RAMSEY (ADOPTED`), Michale (William's five-times-great-grandson).
130	44	RAMSEY, Afton Ernstine (Marier) (William's four-times-great-granddaughter).
128	44 Earl Efton (Butch) (William's four-times-great-grandson).
252	44 Earl N (William's great-great-great-granddaughter's husband).
54	11 Melinda (adopted) (William's five-times-great-granddaughter).
555		RAYNOR, Jake (Sarah Jane Raynor's father).
366	73 Sarah Jane (William's daughter-in-law).
249	43	REAM, Gladys Eleanor (William's great-great-great-grandson's wife).
216	58	REDMAN, Kathleen Marie (William's four-times-great-granddaughter).
220	58 Kathryn Victoria (William's four-times-great-granddaughter).
287	58 Ronald Clark (William's great-great-great-granddaughter's husband).
221	58 Ronnie Wesley (William's four-times-great-grandson).
167	26	REED, Danielle (William's four-times-great-grandson's wife).
355		RHINEHEART, Elizabeth (William's grandson's wife).
162		RHOADS, Rita Dianne (William's four-times-great-grandson's wife).
507		ROGERS, Thomas (Charles Alonzo Kennaday's uncle by marriage).
188	52	ROGERSON, Robert Harry (William's four-times-great-grandson).
274	52 Robert Orrin (William's great-great-great-granddaughter's husband).
190	52 Ruth Orrine (William's four-times-great-granddaughter).
189	52 Wilma Elaine (William's four-times-great-granddaughter).
522		RYNEARSON, Samuel (Charles Alonzo Kennaday's great-uncle by marriage).
445		SADLER, Mr. (John David Kelley's uncle by marriage).
425	 Raymond (John David Kelley's cousin).
558		SAPP, Archie (Cristine Sapp's brother).
560	 Clara Belle (Cristine Sapp's sister).
420	 Cristine (John David Kelley's sister-in-law).
556	 Everett (Cristine Sapp's brother).
561	 John Harvey (Cristine Sapp's father).
557	 Lizzie (Cristine Sapp's sister).

<u>Ref.</u>	<u>Tree</u>	<u>Name (Relationship)</u>
559		SAPP, Roy (Cristine Sapp's brother).
276		SCHILLING, Vyril M (William's great-great-great-granddaughter's husband).
239	61	SCHMELING, Amy Nichole (William's four-times-great-granddaughter).
296	61 Craig Martin (William's great-great-great-granddaughter's husband).
238	61 Tyler Martin (William's four-times-great-grandson).
157		SCHOENWALD, Jim (William's four-times-great-granddaughter's husband).
528		SCOMP, Annie E (Charles Alonzo Kennaday's great-aunt).
525	 George (Charles Alonzo Kennaday's great-uncle).
530	 Hanna (Charles Alonzo Kennaday's great-aunt).
527	 Henry (Charles Alonzo Kennaday's great-uncle).
535	 Jacob (Charles Alonzo Kennaday's great-grandmother's husband).
526	 John (Charles Alonzo Kennaday's great-uncle).
529	 Sally (Charles Alonzo Kennaday's great-aunt).
371		SCOTT, Donna (John David Kelley's great-niece).
370	 Gary (John David Kelley's great-nephew).
395	 Pete (John David Kelley's niece's husband).
99	35	SELF, Ashley Chester (William's five-times-great-grandson).
98	35 Ian Mathew (William's five-times-great-grandson).
185	35 Stanley Howard (William's four-times-great-granddaughter's husband).
97	35 Stuart Branson (William's five-times-great-grandson).
554		SELLERS, Elizabeth (Sarah Ann Ankrom's grandmother).
351		SHEPHERD, Benjamin Kirk (William's granddaughter's husband).
333	69	SHIDLER, Alferd (William's great-granddaughter's husband).
219		SHOEMAKER, Jamie Paul (William's four-times-great-granddaughter's husband).
536		SKELTON, James Franklin (Mary Elizabeth Skelton's father).
347	 Mary Elizabeth (William's great-grandson's wife).
48	19	SLOANE, Larry (William's five-times-great-grandson).
47	19 Lisa (William's five-times-great-granddaughter).
146	19 Mr. (William's four-times-great-granddaughter's husband).
456		SMITH, Elizabeth (John David Kelley's great-grandmother).
95	34 Fred Winton (William's five-times-great-grandson).
183	34 Fred Winton (William's four-times-great-granddaughter's husband).
164	24 Paula Jo (William's four-times-great-grandson's wife).
534		SMOCK, Mary Vicker (Charles Alonzo Kennaday's great-grandmother).
18	8	SOBO, Brenda Sue (William's five-times-great-granddaughter).
123	8 Cornell Alexander, Jr. (William's four-times-great-granddaughter's husband).
4	2 Julie Erin (William's six-times-great-granddaughter).
3	2 Justin Kyle (William's six-times-great-grandson).
20	8 Randy Eugene (William's five-times-great-grandson).
22	8 Teresa Lynn (William's five-times-great-granddaughter).
5	2 Travis Andrew (William's six-times-great-grandson).
6	2 Tyler Jamison (William's six-times-great-grandson).
61		STAMPS, George (William's five-times-great-granddaughter's husband).
246	63	STEWART, Charles Leroy (William's great-great-great-grandson).
316	63 Ed (William's great-great-granddaughter's husband).
243	63 Frances Luella (William's great-great-great-granddaughter).
244	63 George Martin (William's great-great-great-grandson).
242	63 Mable Vilote (William's great-great-great-granddaughter).
245	63 Olive Ruth (William's great-great-great-granddaughter).
254	45	STOCKWELL, Ellen (Dude) (William's great-great-great-granddaughter's husband).
144	18	STURGESS, Jo Ann (William's four-times-great-grandson's wife).
136	14	THOMPSON, Alice (William's four-times-great-grandson's wife).
94	33 Bradly Tommy (William's five-times-great-grandson).
175	30 Carolyn M (William's four-times-great-grandson's wife).
181	33 Tommy M (William's four-times-great-granddaughter's husband).
501		THORNHELL, Reubin (Charles Alonzo Kennaday's uncle by marriage).
211		TOMAYER, Gerald Noller (William's four-times-great-granddaughter's husband).
406		TREADWAY, Mr. (John David Kelley's niece's husband).
340		TREDWAY, Lillie (William's great-grandson's wife).
311		UNKNOWN, Alice (William's great-great-grandson's wife).
64	 Barbara (William's five-times-great-grandson's wife).
428	 Bill Tom (John David Kelley's cousin).

<u>Ref.</u>	<u>Tree</u>	<u>Name (Relationship)</u>
388		UNKNOWN, Billy Joe (John David Kelley's great-nephew).
387	 Bonnie Sue (John David Kelley's great-niece).
373	 Charles (John David Kelley's great-nephew).
390	 Chip (John David Kelley's great-nephew).
374	 Clarence (John David Kelley's great-nephew).
375	 Elizabeth Faye (John David Kelley's great-niece).
532	 Ellen (Charles Alonzo Kennaday's great-grandmother).
427	 Eugene (John David Kelley's cousin).
426	 James (John David Kelley's cousin).
389	 Jimmy (John David Kelley's great-nephew).
391	 Kim (John David Kelley's great-niece).
247	 Lucy (William's great-great-great-grandson's wife).
537	 Mary Jane (Mary Elizabeth Skelton's mother).
562	 Mary Miranda (Cristine Sapp's mother).
448	 Mr. (John David Kelley's uncle by marriage).
413	 Ms. (John David Kelley's nephew's wife).
397	 Opal (John David Kelley's nephew's wife).
550	 Ruth (Sarah Ann Ankrom's mother).
509		VAN ORSDEL, Abram (Charles Alonzo Kennaday's uncle).
517	 Abram F, Jr. (Charles Alonzo Kennaday's grandfather).
531	 Abram Van Orsdel (Charles Alonzo Kennaday's great-grandfather).
488	 Anne Elizabeth (Charles Alonzo Kennaday's mother).
512	 Henery George (Charles Alonzo Kennaday's uncle).
510	 Isabell (Charles Alonzo Kennaday's aunt).
498	 James H (Charles Alonzo Kennaday's uncle).
500	 Mary B (Charles Alonzo Kennaday's aunt).
504	 Melinda Catherine (Charles Alonzo Kennaday's aunt).
502	 Rebecca Ellen (Charles Alonzo Kennaday's aunt).
506	 Sarah E (Charles Alonzo Kennaday's aunt).
496	 William George (Charles Alonzo Kennaday's uncle).
524		VAN ORSEDEL, Jane (Charles Alonzo Kennaday's great-aunt by marriage).
511		WALLACE, James H (Charles Alonzo Kennaday's uncle by marriage).
399		WALTON, Mr. (John David Kelley's niece's husband).
320		WEIBEL, Ester (William's great-great-grandson's wife).
215		WELLS, Richard Lee (William's four-times-great-granddaughter's husband).
55		WERT, Gregory (William's five-times-great-granddaughter's husband).
27		WHITE, David Lester (William's five-times-great-granddaughter's husband).
344		WHITED, Louise (William's great-grandson's wife).
174	51	WHITMAN, Boyd David (William's four-times-great-grandson).
272	51 Bruce Douglas (William's great-great-great-granddaughter's husband).
187	51 Charles (William's four-times-great-grandson).
178	51 Charlotte Louize (William's four-times-great-granddaughter).
96	34 Collin Wade (William's five-times-great-grandson).
90	31 Gail Robin (William's five-times-great-granddaughter).
89	31 Grant Douglas (William's five-times-great-grandson).
184	51 Laurel Alice (William's four-times-great-granddaughter).
180	51 Marcella Ann (William's four-times-great-granddaughter).
85	29 Marcus Pine (William's five-times-great-grandson).
461	 Marcus Pine (Bruce Douglas Whitman's son).
86	30 Micheal Gerald Sturm (William's five-times-great-grandson).
88	30 Nathanielle Rebecca (William's five-times-great-granddaughter).
170	51 Nelson Chester (William's four-times-great-grandson).
87	30 Patrick Keith (William's five-times-great-grandson).
84	28 Peri Ann (William's five-times-great-granddaughter).
182	51 Phillis Lana (William's four-times-great-granddaughter).
176	51 Richard Ward (William's four-times-great-grandson).
83	28 Robbyn Cherter (William's five-times-great-grandson).
138	15	WILLIAMS, Carolyn (William's four-times-great-grandson's wife).
487	 John (Charles Alonzo Kennaday's mother's husband).
293	60	WILSON, Albert Norman (William's great-great-great-granddaughter's husband).
235	60 Kenneth Logan (William's four-times-great-grandson).
236	60 Phyllis Ann (William's four-times-great-granddaughter).

<u>Ref.</u>	<u>Tree</u>	<u>Name (Relationship)</u>
234	60	WILSON, Richard Norman (William's four-times-great-grandson).
349	72	WIRTZ, Jesse (William's great-granddaughter).
520		WOOD, Gideon (Charles Alonzo Kennaday's great-uncle by marriage).
29		WURTZ, Dairld Gean (William's five-times-great-granddaughter's husband).
169	27	YOUNG, Brigid Ann (William's four-times-great-grandson's wife).