

SOFTWARE UPDATE

1. Requirement

The following tools / equipment are required to update the MR-8 software.

- 1) IBM PC/AT computer with USB ports, in which Windows Me / 2000 / XP OS is running
- 2) 128 MB Compact Flash (abbreviated as CF) card which is supplied with MR-8
- 3) WinZip compressed software update file
- 4) A Utility software to extract WinZip compressed software update file
- 5) USB cable

2. Connection

Connect the USB cable between the MR-8 USB port on the rear panel and the PC USB port.

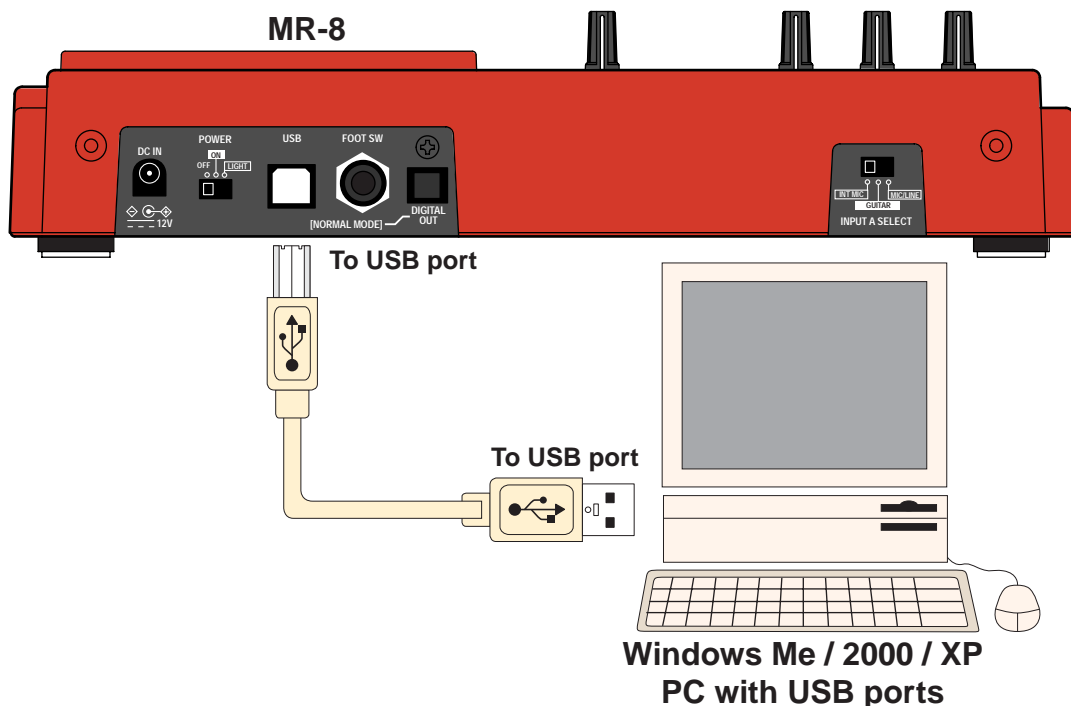

3. Software Updating Procedures

The following explanation presumes that a WinZip compressed software update file is correctly sent to you via email, copied into your computer and the 128MB CF card supplied with MR-8 is properly recognized by MR-8.

- 1) Using a utility software, extract a WinZip compressed software update file “MR8VXXX.zip” on the PC. (XXX indicates the software version number.) A newly created software update file name will be “mr8_mvX.XX” (XXX indicates the software version number. In the case that the software version number is V1.03, the software update file name will be “mr8_mv1.03”.) Place the software update file “mr8mvX.XX” on the PC Desktop.
- 2) Plug the 128MB CF card supplied with MR-8 into the card slot on the right side and power on MR-8.
- 3) Press the [MENU] key on the MR-8 to enter the menu mode.

The MENU screen appears on the MR-8 LCD, in which “System” is highlighted.

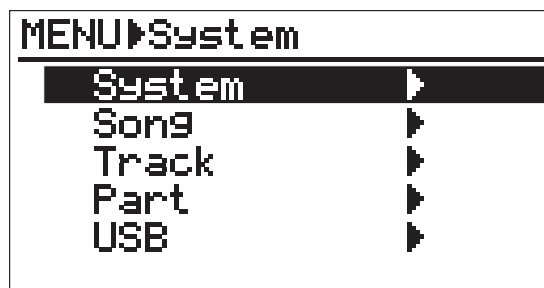

- 4) Highlight “USB” using the [CURSOR⤴] key and then press the [ENTER] key or [CURSOR⤵] key. MR-8 enters the USB mode, while the display shows the screen on the right.

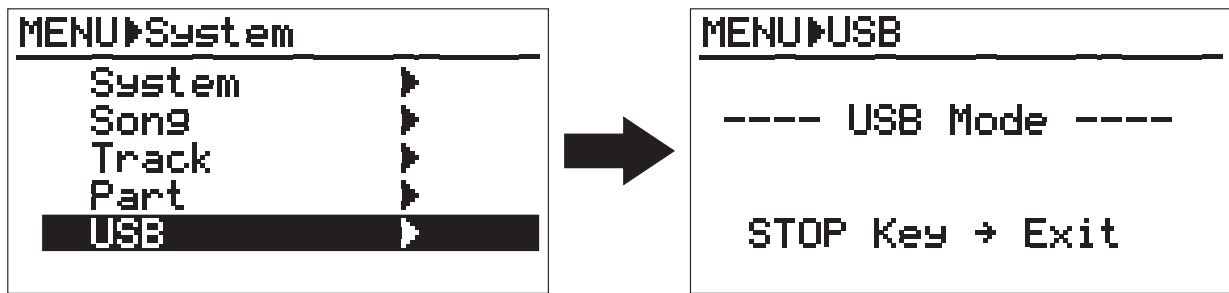

- 5) Open “My Computer” on the PC monitor.
 You see the “Removable disc” drive newly added on the PC. The first time you connect MR-8, the device driver is automatically installed.
- 6) Copy the extracted software update file “mr08_mvX.XX” into the root directory of the newly recognized “Removable disc” drive (CF card inside MR-8).

NOTE: When copying the software file from PC to MR-8, either reformatting the CF card or backing up the song data is not required. Simply copy the software file to the CF card root directory. All you need is about 1.6MB of free memory space on the CF card to copy the software file.

- 7) After copying the software file is completed, press the STOP key to get out of the USB mode.
- 8) Disconnect the USB cable and power off MR-8.
- 9) While holding down the STOP key on the MR-8 top panel, power on MR-8 by sliding the power switch to the left. If the software update file is correctly placed in the root directory, the screen below will appear on the MR-8 LCD.

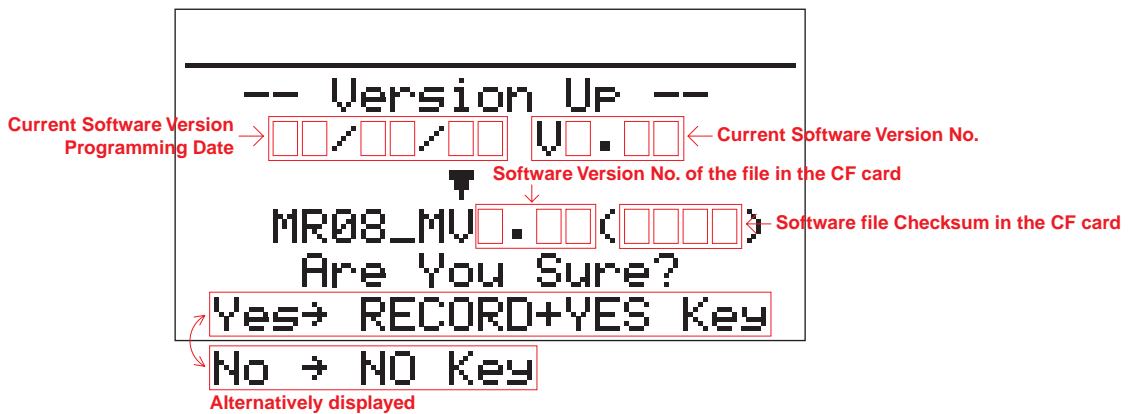
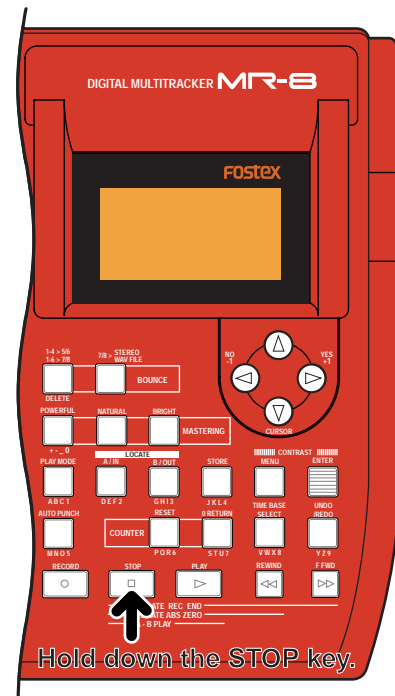
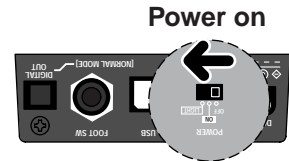

- 10) If the screen on your MR-8 matches one of the before listed examples, press the CURSOR RIGHT / YES / +1 (⊕) keys while holding down the RECORD key to start updating the software. While updating the software, the screen below appears on the LCD. At the same time, the insert effect MIC SIMULATION CONDENSER key starts flashing in green for several seconds indicating that the Flash ROM inside MR-8 is in the ERASE process. Then, after it is turned off, the insert effect MIC SIMULATION TUBE key starts flashing in green for several seconds indicating that the Flash ROM inside MR-8 is in the WRITE process.

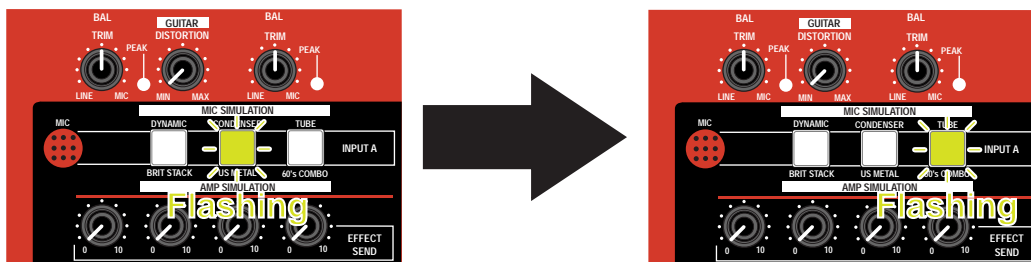
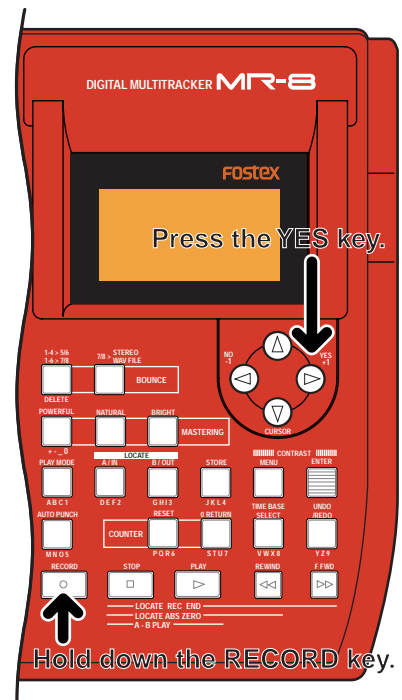
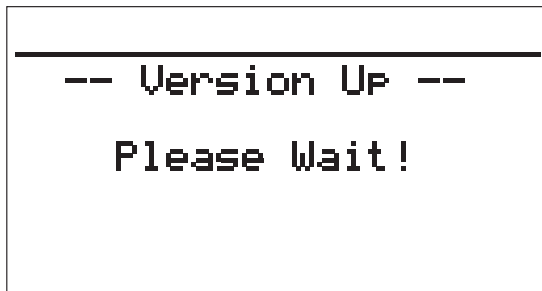

- 11) After updating the software is completed, the screen below with “Completed!” message will be displayed on the LCD. Check if the displayed checksum matches the one displayed in the procedure 9) before. At the same time, both the insert effect MIC SIMULATION CONDENSER and TUBE keys are lit solid in green indicating that the program on the Flash ROM inside MR-8 is correctly erased and written.

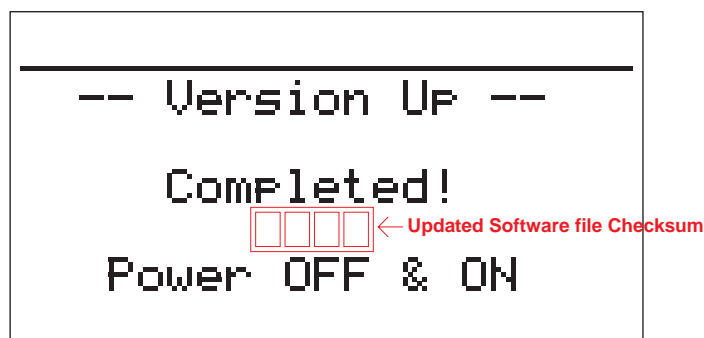

- 12) In order to boot up using the updated software, power off MR-8 and then back on.