

MARVEL SUPER HEROES™

Official Advanced Game Accessory

AVENGERS™ COAST-TO-COAST

by Edward G. Sollers
Adventure by David Cook



All Marvel characters and the distinctive likenesses thereof are trademarks of the Marvel Comics Group. MARVEL SUPER HEROES and MARVEL SUPER VILLAINS are trademarks of the Marvel Comics Group. ©Copyright 1985 Marvel Comics Group, a division of Cadence Industries Corporation. All Rights Reserved. Printed in U.S.A.



TSR, Inc.
PRODUCTS OF YOUR IMAGINATION™

The names of characters used herein are fictitious and do not refer to any persons living or dead. Any descriptions including similarities to persons living or dead are merely coincidental. PRODUCTS OF YOUR IMAGINATION and the TSR logo are trademarks owned by TSR Inc. Game Design ©1985 TSR Inc. All Rights Reserved.

AVENGERS QUINJET

STARK INTERNATIONAL QUINJET A-1 (UNITED STATES)
WAKANDA DESIGN GROUP
T'CHALLA, CHIEFTAIN

Data: Avengers Quinjet A-1

Power Plant: 2 x 2 symmetrically mounted modified Pratt & Whitney J48-P-8A Turbojet engines (each 8,500 pounds static thrust). 1 modified Pratt & Whitney TF33-P-7 Turbofan engine (21,000 lb. S.T. without afterburning)

Wing span: 23' 9"

Length overall, incl. nose probe: 34' 8"

Cabin:

Max. width: 10' 4"

Max. Height: 6' 8"

Normal take-off weight: 29,000 lbs.

Max. level speed at Sea Level: Mach 2.1

Max. rate of climb at S/L: 7,900 feet per min.

Service ceiling: 130,000 feet, with afterburner: 220,000 feet

Range with max. fuel, 5% fuel reserve, 4,000 lbs. (max.) payload: 9,500 miles

Range with max. fuel, 5% fuel reserve, : 11,000 miles

Accommodation: Flight crew of 2 on bi-directional, zero-height Weber escape harnesses, optional seating for 5 passengers

Operational equipment: True Vertical Take-Off and Landing capability by routing 4 smaller engine's exhaust through vertical thrust deflectors

Ordered: 4 models, each with modifications.

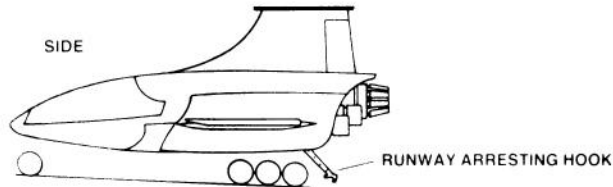
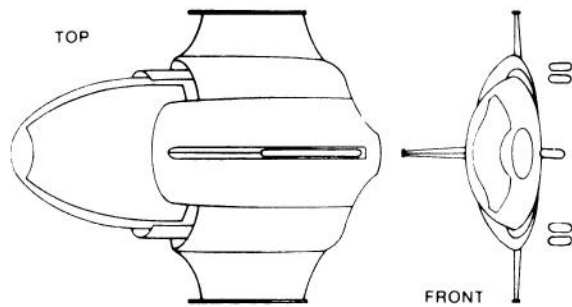

- 1 Pitot head (airspeed indicator)
- 2 Nose wheel
- 3 Torque shock absorber assembly
- 4 Avionics Computer bay
- 5 Electronic Countermeasures electronics bay (ECM)
- 6 Hughes phased array RADAR
- 7 Control column
- 8 Instrument panel
- 9 Radio & electronic equipment bay
- 10 Canopy explosive bolt hardpoints
- 11 Frameless windscreen panel
- 12 Canopy external release handle
- 13 Cockpit front pressure bulkhead
- 14 Cockpit rear pressure bulkhead
- 15 UHF IFF aerial
- 16 Temperature probe
- 17 Forward fuel tank 6,400 lbs
- 18 Forward vertical thrust exhaust
- 19 Hatch fairing
- 20 Retractable ladder bay
- 21 Intake ducting
- 22 ECM aerials
- 23 Escape harness railway shaft (2)

- 24 P&W J48-P-8A turbojet engines (4)
- 25 P&W TF33-P-7 afterburning turbofan engine
- 26 Rudder
- 27 Rudder control units
- 28 Dorsal access panels
- 29 Variable area afterburner nozzle
- 30 Port aft fuel tanks (4) 2,500 lbs. each
- 31 Port aileron (4)
- 32 Aileron control unit
- 33 Vertical thrust deflector ducting
- 34 Variable geometry ducting (forward to vertical thrust)

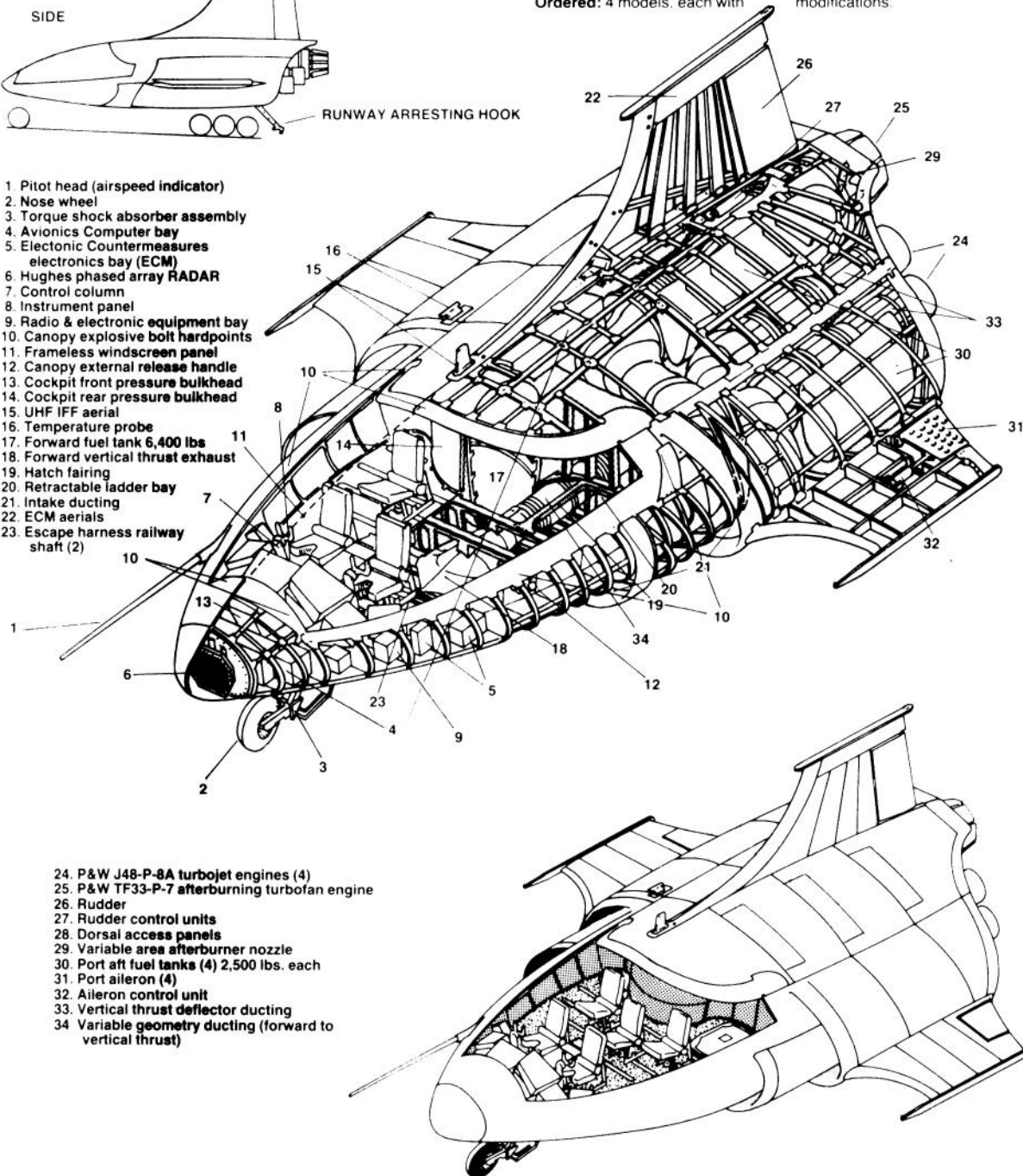

MARVEL SUPER HEROES™

Official Game Accessory

AVENGERS™ COAST-TO-COAST

by Edward G. Sollers
Adventure by David Cook



Table of Contents

Introduction	3
Avengers Charter	4
Avengers and the Government	7
Avengers' Headquarters	9
The Avengers Quinjet	18
Equipment and Locations	19
Avengers	25
Avengers' Allies	37
Villains	41
Index	72

Adventure Section

Avengers Franchised! Adventure	1
Chapter 1: The Phone Call	3
Chapter 2: The Casting Call	5
Chapter 3: Home Sweet ...Headquarters!	12
Chapter 4: The Walk-Ons	14
Chapter 5: Be It Ever So Humble	18
Chapter 6: The Hideout	21



This book is protected under the copyright laws of the United States of America. Any reproduction or other unauthorized use of the material of artwork contained herein is prohibited without the express written consent of TSR Inc., and Marvel Comics Group. Distributed to the book trade in the United States by Random House, Inc., and in Canada, Ltd. Distributed to the toy and hobby trade by regional distributors.

The names of characters used herein are fictitious and do not refer to any person living or dead. Any descriptions including similarities to persons living or dead are merely coincidental. All Marvel characters and the distinctive likenesses thereof are trademarks of the Marvel Comics Group. MARVEL SUPER HEROES and MARVEL SUPER VILLAINS are trademarks of the Marvel Comics Group, a division of Cadence Industries Corporation. ©1986 Marvel Comics Group. All Rights Reserved.

The TSR logo and PRODUCTS OF YOUR IMAGINATION are trademarks owned by TSR Inc.

Game design copyright ©1986 TSR Inc. All Rights Reserved. Printed in U.S.A.

INTRODUCTION

What We Did

Avengers™ Coast-to-Coast is an accessory for the MARVEL SUPER HEROES™ Advanced Set usable for any or all teams of Avengers. Developments in Avengers affairs required a new accessory as much as the publication of the Advanced Set did. So in many ways, what you have in your hands is a far cry from its predecessor MHAC2 *Avengers Assembled!*.

What are the differences? Well, we knew we'd have to go over some of the same ground again, so we tried to find a new approach to the material or a way to expand what we had done before. If you have both products, we think you'll see the difference.

In treating the old villains, we tried to give each a facelift. In choosing new villains, we decided on a mix of historical enemies and the best of the current foes.

We have descriptions of important locations and equipment that have figured prominently in Avengers missions. Some of them are directly linked to the villains we chose.

The Avengers Charter is included herein, and new rules on legal procedure, so Judges can create new and exciting misunderstandings between the Avengers and Earth's Mightiest Government.

The adventure is self-explanatory. We think you'll find it to be out of the ordinary.

Why We Did It This Way

We decided to give this product an historical perspective appropriate to the quarter-century celebration of Marvel Comics. Our reach spans all of Avengers history, from the Space Phantom (Avengers #2) to the fourth Masters of Evil (Avengers #273). In this respect, we did not hesitate to include the great but gone, both heroes and villains.

We also decided upon a deliberately offbeat adventure. In a way, this adventure takes the Avengers back to their roots and allows the noble tradition to be recreated.

It's been a glorious 25 years for Marvel Comics, and they show no signs of slowing down-much like the Avengers themselves. Long may they assemble!

Milestones in Avengers History

This list is a selection of great battles or events in Avengers history and lists those who participated. As with all lists of this kind, there

is a possibility that some characters have been left off. However, if this list inspires anyone to re-read some of those fine old issues, it will have been a success, errors and all.

Avengers #1: Rick Jones' distress call to the Fantastic Four is diverted to Thor, Ant-Man, Wasp, and Iron Man. They battle the Hulk and Loki. The five heroes decide to band together as the Avengers.

Avengers #2: The time-traveling Space Phantom breaks the unity of the Avengers by fighting them as imitations of themselves. Henry Pym becomes Giant Man and the Hulk leaves.

Avengers #4: The Avengers rescue Captain America. Possibly the most important story in their history.

Avengers #16: The founding members leave, and the new line-up is Captain America, Hawkeye, Scarlet Witch, and Quicksilver.

Avengers #28: The Avengers battle the Collector, who would later help them against Korvac. Avengers include Captain America, Hawkeye, Scarlet Witch, Quicksilver, Goliath, and Wasp.

Avengers #52: The Grim Reaper makes his first appearance, and the Black Panther joins. Avengers include Captain America, Hawkeye, Goliath, and Wasp.

Avengers #57: The Avengers fight Ultron-5 and the Vision debuts. The Avengers are Wasp, Goliath, Black Panther, and Hawkeye.

Avengers #60: The Wasp and Yellowjacket are married.

Avengers #66: The Avengers fight the adamantium Ultron-6. This is the first mention of adamantium. Avengers include Thor, Iron Man, Yellowjacket, Wasp, Goliath II, Vision, and Black Panther.

Avengers #89-97: The Kree-Skrull War. Avengers include Wasp, Yellowjacket, Goliath II, Scarlet Witch, Vision, Thor, Captain America, Iron Man, and Quicksilver. Allies include Captain Mar-Vell, Rick Jones, and Nick Fury.

Avengers #125: The War Against Thanos. The main battle takes place in the CAPTAIN

MARVEL™ comic. Avengers include Iron Man, Captain America, Vision, Scarlet Witch, Black Panther, Mantis, and Swordsman. Allies include Mentor, Starfox, Moondragon, Drax the Destroyer, and Captain Mar-Vell.

Avengers #161-162: Jocasta is built, and the Avengers fight Ant-Man and Ultron. Avengers include Captain America, Vision, Scarlet Witch, Wonder Man, Black Panther, Wasp, and Ant-Man.

Avengers Annual #7: The Second Thanos War. Avengers include Beast, Captain America, Iron Man, Moondragon, Scarlet Witch, Thor, and Vision. Allies include Captain Mar-Vell and Adam Warlock. Thanos dies in Marvel Two-In-One Annual #2, the sequel to this story.

Avengers #167-177: The Korvac War. Avengers and their allies include Wasp, Yellowjacket, Captain America, Vision, Scarlet Witch, Iron Man, Hawkeye, Thor, Quicksilver, Beast, Black Panther, Black Widow, Hercules, Wonder Man, Jocasta, Captain Mar-Vell, Ms. Marvel, Moondragon, and the Guardians of the Galaxy.

Avengers #181: Henry Peter Gyrich lays down the law. The new roster consists of Iron Man, Vision, Captain America, Scarlet Witch, Beast, Wasp, and Falcon.

Avengers #213: The court-martial of Yellowjacket. The Avengers include Captain America, Thor, Wasp, Iron Man, Tigra, and Yellowjacket.

Avengers #246: The beginning of the West Coast Avengers. Hawkeye and Mockingbird are the first Whackos.

Avengers #259-260: The Skrull Civil War. The Avengers battle Nebula and destroy Sanctuary II. Avengers include Captain America, Wasp, Hercules, Starfox, Captain Marvel, and Black Knight. Allies include Firelord and Skrull General Zedrao.

Avengers #273: Avengers Mansion falls to the fourth Masters of Evil. No Avenger is present; Jarvis becomes a prisoner.

AVENGERS CHARTER

BE IT KNOWN...

That we, the Avengers, have banded together to protect and safeguard the planet Earth, its inhabitants and resources, from any and all threats, terrestrial or otherwise, which are or might prove to be beyond the power of conventional forces to handle.

That we shall brook no interference in the growth of mankind in meeting its rightful destiny.

That we dedicate ourselves to the establishment, growth, and preservation of peace, liberty, equality, and justice under law.

THIS IS OUR SOLEMN OATH.

Article One: Organization

The Avengers is hereby chartered as a non-profit organization under the laws as set down by the State of New York, United States of America; said organization being recognized and fully sanctioned as a peace-keeping force by the National Security Council of the United States of America, by the United Nations, and by the Supreme Headquarters International Espionage Law Enforcement Division.

Article Two: Jurisdiction

In accordance with the tenets of national and international law, the Avengers, acting individually, or as a group, are herein authorized to function in all lands, territories, or protectorates of the United States; in all countries allied with the United States by international treaty; and in all countries belonging to or affiliated with the United Nations.

Article Three: Funding



As a non-profit organization, the Avengers shall be funded chiefly by private grants. Major funding for the activities of the Avengers, for its headquarters, transportation, and equipment, shall be provided by a grant from the Maria Stark Foundation (Anthony Stark, Director) with the understanding that the Foundation shall have no say in Avengers operations, or in the deployment of funds within the Avengers organization.

Article Four: Operations

The day-to-day operations of the Avengers shall be governed by a set of by-laws as put forth by the founding members.

IN WITNESS of this charter, we founding

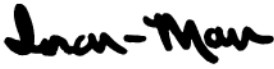
members have hereunto subscribed our names...

	Iron Man
	Thor
	Wasp
	Ant-Man
	Hulk

AVENGERS BY-LAWS

Section One: Policy & Operations

A. All Avengers shall, at all times, endeavor to adhere to the principles of the Avengers Charter and follow the rules and regulations of these by-laws.

1. The by-laws may be amended, when deemed necessary, by the active members of the Avengers. Amendments may be proposed by any active Avenger. Amendments shall become a binding part of these by-laws upon approval by two-thirds of the active membership.

B. No Avenger shall be required to surrender knowledge of his or her civilian identity or personal affairs to the membership at large or the National Security Council.

C. Avengers shall be entitled to special priority government security clearance, as administered and approved by the National Security Council.

D. The Avengers shall be led by a duly elected Chairman or Chairwoman. It shall be the duty of this leader to coordinate all Avenger activities, whether business or tactical in nature.

1. The position of Chairman/woman shall be open to any active member who has passed his/her probationary period (See Section *Two, Memberships*).
2. The Chairman/woman shall serve for a term of 6 months. There shall be no limit to the number of successive terms a leader may serve.
3. It shall be the privilege of the Chairman/woman to determine the format of meetings and to call special meetings as he/she sees fit.
4. In the event of the absence, incapacity, or resignation of the Chairman/woman, an interim leader shall be chosen by a

two-thirds vote of the active membership.

Section Two: Membership

A. Recognizing that the membership of the Avengers may be subject to, and, indeed, might profit from change, procedures for the admission of members shall be set forth.

B. Candidates for membership must be legal adults, possessing at least one skill, power, ability, or talent which is deemed valuable by a majority of the active membership.

1. Membership shall not be denied on account of race, color, creed, sex, or condition of birth or origin.
2. Candidates for membership must be nominated by one active member in good standing at a regular or special meeting. Election for membership must be held within one week of nomination and be attended by a simple majority of active members. A two-thirds vote is necessary for election to membership.
3. Newly-elected Avengers shall serve a probationary period of not less than 30 days. a. During the period of probation, the National Security Council shall make an investigation of the new Avenger's public record in order to determine approval for full security clearance. b. While on probation, the new Avenger shall have limited access to Avengers facilities and records. c. At the end of probation, the new Avenger shall assume full active status, unless objections are raised by any active member or by the National Security Council.

C. The Avengers shall select new members whenever the Chairman/woman or two-thirds of the active membership determines that the ranks are not at optimal strength, or when there is a vacancy in the ranks.

1. It shall be the prerogative of the Chairman/woman to limit the number of active members.

D. Active Avengers shall be the designation given to those Avengers who are full-time members.

1. Active Avengers shall be required to log all individual cases into the main computer file, that the entire membership may benefit from the individual's experience.

2. Active Avengers shall be required to attend all regular business meetings. Members who miss more than one meeting per month without submitting an acceptable excuse may face suspension for a period to be determined by a consensus of the other active members (see paragraph G)
3. Active Avengers shall be issued an Avengers identification card and an emergency signal device. a Active members shall be required to answer all emergency calls. If unable to respond, an active member must contact the Chairman/woman at the earliest opportunity to explain his/her absence. b Active members who MISS an emergency call without good reason may be subject to disciplinary action.
4. Active Avengers shall be expected to cooperate with other law enforcement agencies. Although granted certain legal immunities by the Avengers priority clearance, no Avenger shall be considered above the law.
5. Active Avengers shall be paid a stipend of one thousand dollars (\$1,000) per week. Members may choose not to accept their stipends in which case the money shall be placed in their retirement fund. a Active members shall be entitled to tree medical and life insurance benefits. b Active members shall be provided with private quarters where they, if so choosing, may reside. Unlimited meal privileges shall be provided for live-in members.
6. Active Avengers shall be granted unlimited access to the Avengers Mansion headquarters, vehicles, computer records files, and any other facilities of the organization.
7. Active Avengers may take a leave of absence for any reason simply by notifying the Chairman/woman of said intent. Active Avengers may choose to accept status as either a reservist or an inactive Avenger.
8. Active Avengers shall, at all times, act in a manner befitting that of a guardian of the public trust.

E. Reserve Avengers shall be the designation given to those Avengers who are part-time members. on call for special missions or emergency assignments only.

1. Reserve membership shall be limited to those members who have fulfilled an active term of duty of not less than one year, and who wish to reduce their

connections with the group.

2. Reserve Avengers shall not be required to log their Individual cases, though they shall be encouraged to do so.
3. Reserve Avengers may attend any regular meeting, but shall be required to attend no more than one per year.
4. Reserve Avengers shall retain their Avengers identification card and emergency signal device. a Reserve members may be demoted to inactive status if they fail to answer three consecutive emergency calls.
5. Reserve Avengers shall be paid a stipend of one hundred dollars (\$100) per month.
6. Reserve Avengers shall have limited access to Avengers Mansion, Ides, equipment, etc.
7. Reserve Avengers may return to active status at the discretion of the Chairman/woman, if they so petition and are accepted by majority vote of the active members.
8. Reserve Avengers shall be given priority over new candidates in the filling of vacancies in the active membership.
9. Reserve Avengers may retire to inactive Status by notifying the Chairman/woman and surrendering the Avengers identification card and emergency signal device.
10. Reserve Avengers shall not have a vote in Avengers proceedings.
11. Reserve Avengers shall have the authority to call emergency meetings.

F. Inactive Avengers shall be the designation given to those members who have retired or resigned from active and reserve duty.

1. Any Avenger may resign by simply notifying the Chairman/woman of his/her intent and surrendering his/her Avengers identification card, emergency signal device, and any other Avengers owned equipment.
2. Any active or reserve Avenger who is incapacitated or who moves from the organization's normal jurisdiction shall be granted an honorable discharge and placed on the inactive roster.
3. Inactive Avengers may be granted limited access to Avengers equipment and facilities only at the discretion of the active members.
4. Inactive status shall be considered the same as an indefinite leave of absence.
5. Inactive Avenger, may be reinstated only if there is a vacancy in the active ranks, and then only if elected by a two-thirds vote of the active membership.

G. Motions for disciplinary action against any active or reserve Avenger may be brought by

any other active Avenger

1. In the event of a siren accusation, the Chairman/woman shall convene a board of Inquiry, comprising a simple majority of the active membership (minus the accused, if he/she is an active member).
2. Disciplinary action shall be limited to suspension, with the option of further trying the accused before a tribunal of all active members.
 - a. Tribunal proceedings shall be conducted in the manner of a military court-martial.
 - b. Maximum punishment to be brought on the accused by such a tribunal shall be expulsion from the Avengers.
 - c. A two-thirds vote shall be necessary to expel a member from the Avengers.
3. Active and reserve Avengers can be expelled, with no possibility of reinstatement, on the following grounds.
 - a. Conviction for any crime above a misdemeanor.
 - b. Deliberate betrayal of Avengers classified Information.
 - c. Criminal acts of negligence not convicted for, but witnessed by at least one active member.

Section Three: Meetings

A. The Avengers shall meet regularly, at least once a week, at a time and place to be agreed upon by a simple majority of the active membership.

B. Emergency meetings may be called at any time, but emergency meeting, shall not be considered a replacement for a regular meeting.

C. In the event that an Avengers mission is in progress at the time of a regularly-scheduled meeting, the meeting will be rescheduled.

D. A simple majority of the active membership shall be required to make a meeting official.

Section Four: Punishment of Criminals

A. Avengers shall leave the punishment of perpetrators of criminal activity to the appropriate agencies of the law.

B. The Avengers shall not abridge an accused's right to a fair and speedy trial.

C. The Avengers shall abide by the decisions of the law, and will not take upon themselves any aspect of the punishment process.

D. In the event that conventional imprisonment proves inadequate for a given criminal, the Avengers shall be allowed to hold said criminal in a manner they see fit, provided that a full report of said methods of imprisonment is given to the proper law enforcement authorities.

Section Five: Affiliations

The Avengers shall maintain open and reciprocal relations, including joint limited access to computer data, with the Fantastic Four, Inc and with the Supreme Headquarters International Espionage Law Enforcement Division (S.H.I.E.L.D.).

Section Six: Security

The National Security Council shall serve as liaison between the Avengers and the government of the United States. The NSC shall have the power to revoke the Avengers security clearance, individually at collectively The NSC shall supervise the installation of all security devices and data centers and shall hold periodic inspections of said facilities.

Section Seven: Discorporation

The Avengers organization may be disbanded only by order of the National Security Council for a breach of national security, or by unanimous vote of the entire active membership of the Avengers. In the event of disbanding all Avengers properties and facilities shall revert to the Mane Stark Foundation and/or Stark International, with the exception of any security devices, analysis systems or data which has any bearing on national security. Said materials and data shall be immediately turned over to the government of the United States.

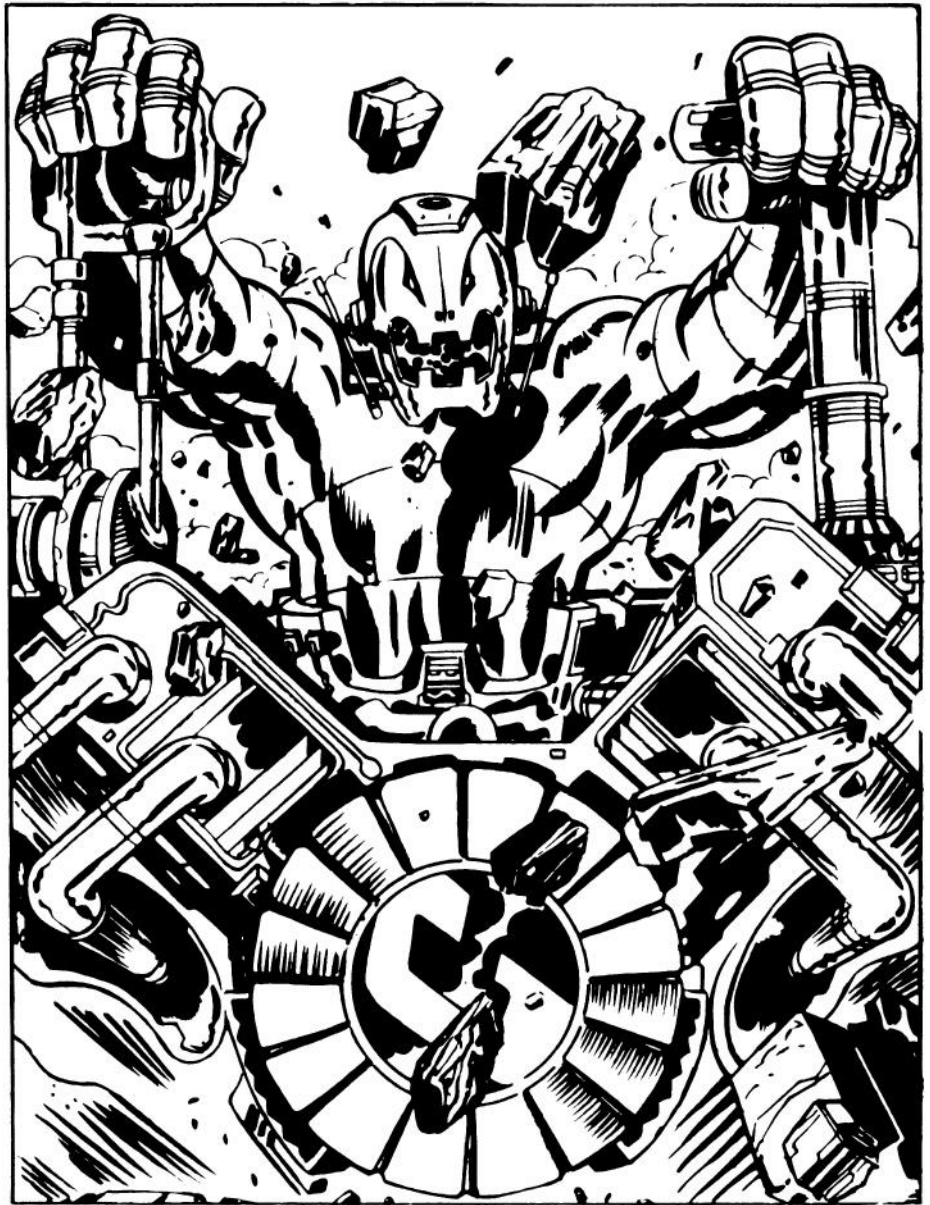

TM

AVENGERS AND THE GOVERNMENT

The Avengers are the first hero group to receive official recognition from U.S. Government (and from international organizations as well). National governments realized that the Earth could be threatened by alien races like the Skrulls or despots with world-wide ambitions. The Avengers were therefore sponsored by the National Security Council of the U.S. Government and by the United Nations as well, and this support was written into the Avengers Charter. This support has been retained and expanded over the years, but not without difficulty. Government support for the Avengers includes access to privileged or classified information, exemption from certain Federal regulations, and a wide-ranging elimination of the kind of red tape that usually accumulates after heroes demolish a world-threatening menace along with the city block where said menace had been standing. Government support does not extend to providing funds to support Avengers activities. The Avengers are funded by a self-perpetuating private trust fund, the Maria Stark Foundation. The U.S. government cannot get n hands on the Avengers pursestrings (in this respect, this Avengers are better off than some other government-sponsored groups.

Legal Powers: Avengers can arrest anyone found in the act of committing a crime and the Avengers can temporarily confine arrested criminals if the criminal is too powerful to be confined by normal means. The Avengers normally turn over to appropriate authorities all but the most powerful super-villains as soon as possible.

Avengers have no authority to judge or punish criminals on their own.

The Avengers have additional legal privileges because of their security clearance. These privileges can be limited or suspended by the National Security Council.

Official Contacts: Contacts for the Avengers as a group fall into four categories.

1. U S (Federal) Government. They include:
 - A. The President (direct access is limited to the Avengers Chairman).
 - B. The National Security Council (advisors to the President and government liaison to the Avengers).
 - C. The Federal Bureau of Investigation (Investigates most Federal crimes).
2. U.S Military. The following Two are most important, although the Avengers can be called upon by any military command that needs their help.

- A. North American Air Defense Command, USAF (responsible for defense against attack from air or space)
- B. Strategic Air Command, USAF (the country's major nuclear arsenal; also stores materials vital to national defense, like concerti resins).

3. Local Governments. The Avengers have an emergency number that can be used by any state or local agency that needs their help. The Avengers have special emergency telephone numbers for the cities whom they are based.

New York City Police Department
Los Angeles Police Department

Expansion teams like the AEF (Avengers Experimental Franchise) will also be expected to set up special local numbers.

4. International Agencies. There are several of these.
 - United Nations
 - Supreme Headquarters, International Espionage Law Enforcement Division, S.H.I.E.L.D. (combats subversion by super-villains and world-wide conspiracies like AIM and HYDRA)
 - Interpol (criminal investigation and information gathering agency).

Contacts for individual Avengers are listed in the MARVEL SUPER HEROES Advanced Set or in the roster section of this book.

Security Clearances and Government Liaisons.

All active and reserve Avengers are issued Priority Identification Cards, signed by the President and the Director of the National Security Council. These cards exempt the Avengers from the restrictions of various bothersome Federal regulations such as restrictions on the operation of supersonic aircraft, provide access to high-security data or installations such as Project Pegasus or SAC headquarters, and even allows them to commandeer assistance on an emergency basis. Provisional or inactive Avengers carry cards that allow them restricted access to the most highly-classified data or equipment.

Avengers priority also ensures that government employees can freely cooperate with the Avengers without getting in trouble with their own superiors.

The result of all this is that when disaster or major mayhem threatens, Avengers usually get a lot of cooperation from the authorities and can get to work with minimum delay. In such cases, the Avengers usually take charge, and the locals are relegated to crowd control until the heroes take care of the menace. The arrangement has

saved countless lives in the past.

The National Security Council of the U.S. Government assigns a liaison officer to handle most official contacts between the Avengers and the government. The duties of the liaison officer are as follows:

1. To monitor compliance with security procedures designed to protect secret data and equipment.
2. To examine a prospective Avenger's fitness to receive a security clearance, and to assign the appropriate level of clearance.
3. To supervise the installation or removal of physical security or defense systems at Avengers' headquarters.
4. To handle the Avengers' requests for information or assistance from the U.S. Government.
5. To handle any official paperwork that the Avengers want to avoid doing, since none of the Avengers has a bureaucratic personality.

The first government liaison officer was Henry Peter Gyrich. He pursued the goal of tight security with by-the-book zeal, and was eventually transferred at his own request and replaced by Raymond Sikorsky, who has been far more helpful and understanding than Gyrich. However, Sikorsky is Gyrich's subordinate, and Gyrich can overrule Sikorsky's, decisions.

Henry Peter Gyrich

F A S E R I P
Gd Gd Ty Ty Gd Gd Ty
Health: 32 Karma: 30
Resources: Am Popularity: 10

The hardheaded Gyrich is known as "Bad News Pete" even among his own colleagues. He demanded the submission of frequent reports and paperwork, dictated the Avengers roster, frequently made unreasonable restrictions and demands, and at one point tried to have the Avengers branded as threats to national security. He was completely unawed by super heroes to the point of reckless courage; he attempted to capture the powerful mutant Rogue with a weapon that had never been tested.

Raymond Sikorsky

F A S E R I P
Ty Ty Ty Ty Gd Gd Ty
Health: 24 Karma: 26
Resources: Am Popularity: 20

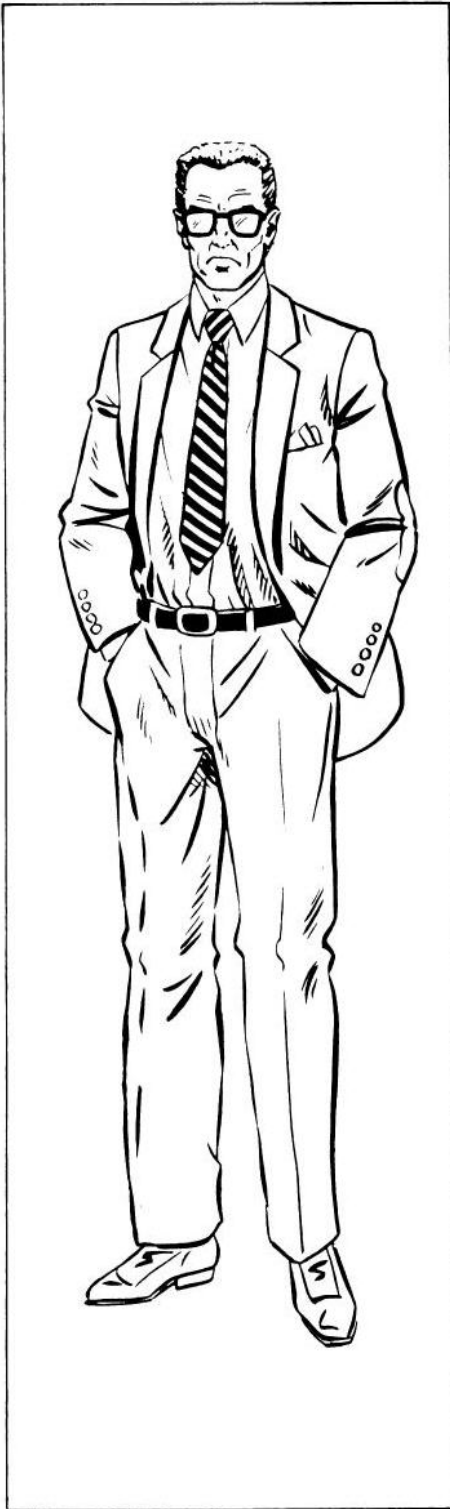

Sikorsky is portly, balding, middle-aged, and temperamentally the opposite of Gyrich. He sees his job as making sure that any reasonable request by the Avengers is granted. He seems a little intimidated by the Avengers, and is always a little nervous. His non-confrontational style has been far more helpful than Gyrich's abrasive regime

Security Clearances and Classified Data.

The following various levels of security clearance are listed from highest clearance to lowest

- Magic
- Top Secret, Ultra
- Ultra-Secret
- Top Secret
- Secret, Restricted
- Secret
- For Eyes Only
- Confidential
- Sensitive

Inactive Avengers do not have access to classified data. Probationary and Reserve Avengers are limited to "Secret"-level data or below Active Avengers are assigned a maximum "routine" clearance, usually Top Secret, and information in higher categories usually requires that the character make a successful Popularity FEAT to obtain it. The intensity of the FEAT is set by the Judge.

The classification system only applies to government held data. All Avengers and ex-Avengers have free access to records of Avengers cases or to files shared with the Fantastic Four.

Security clearances for an expansion team like the AEF are discussed in the adventure section.

Security Restrictions. At present, Avengers priority is restricted as a result of the Vision's recent attempt to seize control of the world. The Avengers no longer have direct access to high-security data in government computer systems (Ultra Secret or higher classification) and they can no longer base Quintets at their New York headquarters. It is unknown how long these restrictions will be in effect

Dirty Secrets. Despite the fact that relations between the U.S. Government and the Avengers are fairly good, each sometimes withholds information from the other. For example, the government has concealed from the Avengers the official support behind the Sentinel program and the existence of Project Wideawake, the government's mutant investigation program. The government has also set up two programs to create operatives willing to undertake dirty jobs that the

Avengers would never touch - Protect Rebirth, which created the insane super-soldier Nuke, and Freedom Force, formerly the New Brotherhood of Evil Mutants (from the government's standpoint, Freedom Force is a desirable development because government control over it is far greater than over the Avengers). On their part, the Avengers have withheld what they know about the X-Men and Professor Xavier's School for Gifted Youngsters (information presumably provided by the Beast), to avoid fanning the flames of anti-mutant prejudice.



AVENGERS' HEADQUARTERS

A hero group needs a secure headquarters, with enough hardware to enable the group to meet its responsibilities. No one understands this better than the Avengers. For the Earth's Mightiest Heroes, only the very best will do.

An Avengers headquarters is always a Deluxe Installation, with certain standard features. Currently, there are two such headquarters, in New York and California. An Avengers expansion team, like the one in the Avengers Franchised adventure, will be less lavishly equipped but will have the opportunity to expand their facilities as they prove themselves worthy to be called Avengers.

Funding for Avengers headquarters, as for all Avengers activities, comes from the Maria Stark Foundation. This is an independent trust fund of Remarkable resource rank, kept totally separate from Tony Stark's business ventures. For expansion teams, funding will be limited until they prove themselves to be more experienced members.

Avengers Mansion

The holding at 890 Fifth Avenue in New York has become world-famous as the home of the Avengers. It was originally built in 1932 by industrialist Howard Anthony Stark as his Manhattan home. The mansion reflects the most advanced architectural techniques of the time, including reinforced concrete construction. In addition to the three-story, residential building, Howard Stark built a deep basement used for private weapons testing. The basement areas were later expanded by the Avengers to serve as the main areas of their headquarters.

When the Avengers were organized, Tony Stark (Iron Man) donated the mansion to the Avengers for their permanent use. Iron Man and Thor moved the mansion back from the street to allow greater expansion of the underground areas.

Mansion Grounds

The grounds are surrounded by a 12-foot high steel reinforced concrete wall of Monstrous strength material. The lawn includes various sensor systems, but is not otherwise unusual (see Security Systems).

A three car garage, located on the grounds. The entire floor of the garage is also a hydraulic elevator (load Capacity 160 tons) that connects with all underground levels. Since the Avengers' primary vehicle is the Quintet, the garage is seldom used for parking.

Ground Floor

This floor includes the library, a conference room, dining hall, kitchen, pantry, and Edwin

Jarvis' quarters. The grand staircase connects with the second floor. There are two elevators, the larger "A" elevator, connects all levels of the mansion, while the smaller, "B" elevator connects with only the first two underground levels.

The walls, floor, and ceiling are built of Remarkable strength reinforced concrete. The windows and doors are of Excellent strength material. The ground floor is a low-security area, but the elevators can be sealed to prevent access to the underground levels.

Second Floor

This is the residence for Avengers who want to live at the mansion and is also used by guests such as the Fantastic Four. Presently, Hercules and the Black Knight are the only Avengers who have quarters here. This floor includes eight bedrooms, a den/study, and private quarters for Tony Stark (an apartment, office, and workshop). A staircase in Stark's workshop connects with the third floor

The walls and floor are of Remarkable strength reinforced concrete. The windows and doors are of Excellent strength material.

Third Floor

This floor is a hangar and service area for the Quinjets. When fully operational, this floor had a folding wall (to allow take-off and landing), an aircraft carrier style take off and landing system (including catapult, arresting wire, and net barrier), parts storage, fuel storage, a communications room, and three Quinjets. When the Avengers were forced to move their Quintets to Hydrobase, this floor became unused. The landing and takeoff facilities are still in place, however, and at least one unauthorized landing has occurred.

The walls, floor, and ceiling are of Incredible strength reinforced concrete. Doors are of Remarkable strength material. The fold-down wall section is decorated with false windows to match the mansion façade.

Basement

This level contains the danger room, gymnasium, medical facilities, laboratory, pool, arcade, and recreational facilities. The walls floor, and ceiling are of Incredible strength material, except for the danger room (the main training facility), which has walls, floor, and ceiling of Amazing strength material. In addition to its usual features, the medical facility includes an airlock where particularly dangerous specimens can be isolated.

Sub-Basement One

This is the maximum-security level of Avengers Mansion, containing the most critical facilities. This level is the heart of the Avengers headquarters.

This level contains the Avengers assembly room with its famous round table, a computer system with back-up memory bank, two generators and a back-up system of storage batteries, a workshop, and a water cistern

The walls, floor, and ceiling are of Amazing strength material, except for those of the assembly room, which are of Monstrous strength material. Doors have the same strength material as the walls. To enter the assembly room, one must pass two doors, one of Amazing material, and one of Monstrous material.

The computer systems and data files of the New York and California headquarters are constantly linked and share all information. The computers and files of the two main headquarters are also linked with the computers of Hydrobase and those used by any experimental teams like the AEF (Hydrobase and AEF data files are limited by their lower-level security clearance).

Sub-Basement Two

This level includes the shuttle system used for travel to and from Hydrobase, the test chamber for Howard Stark's robot, Arsenal (later used to hold the Vision's world computer control system, now dismantled), and extensive storage facilities for equipment and supplies. A vacuum pump system to prevent flooding in case of catastrophe is installed

Two vehicles are stored here; the borer used to excavate the shuttle tunnel, and a crawler used to service and repair the tunnel (see the Avengers Equipment section for stars on these vehicles).

AVENGERS MANSION

Located at 721 Fifth Avenue
between 70th and 71st Streets
in New York City.

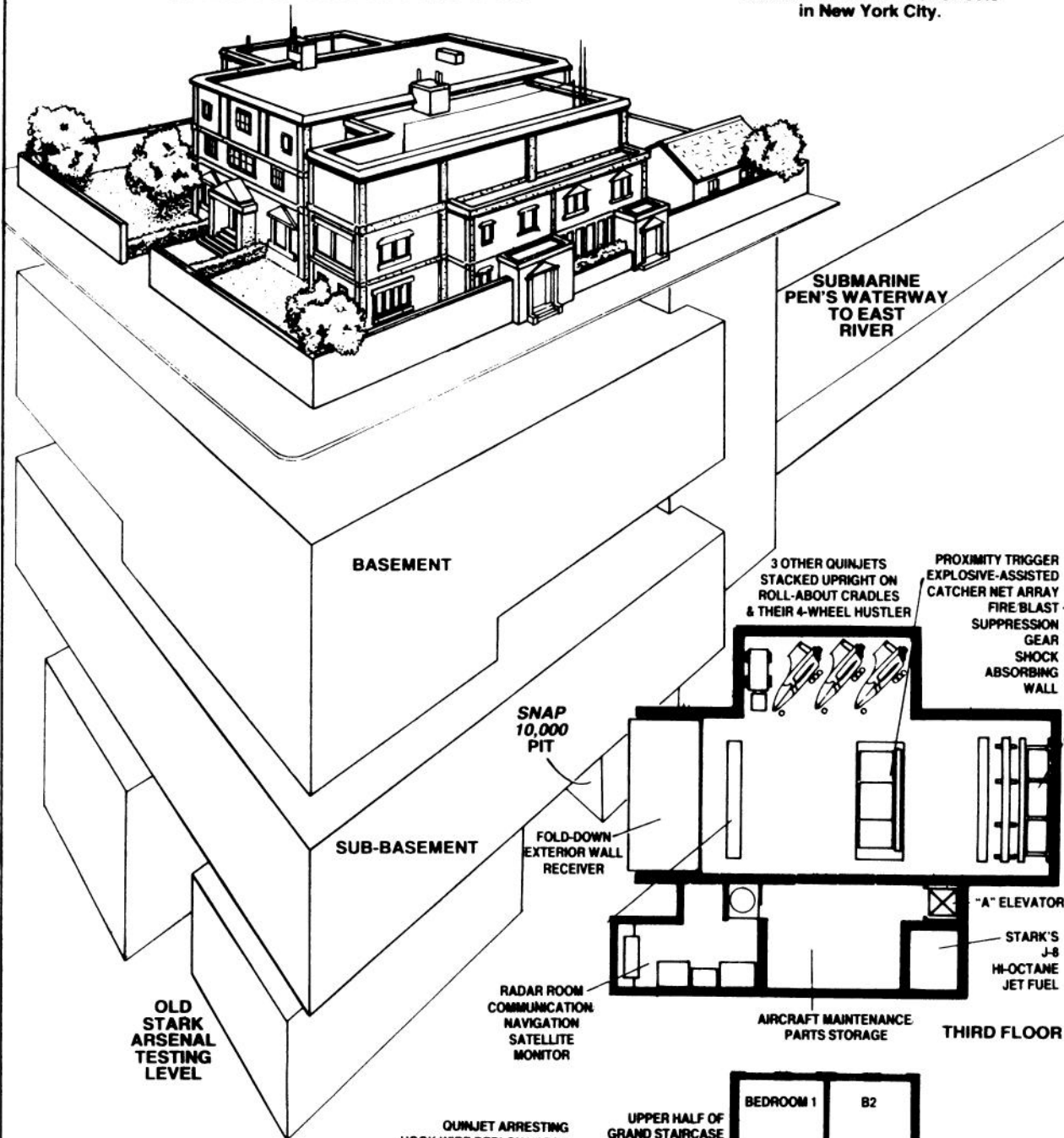

The Avengers Mansion is an eclectic, three-story building. The original structure on the site, built in 1932 by Howard Stark, utilized the then-unusual steel-reinforced concrete technique. The additions have been carefully wedged to this to provide the most flexible use of existing equipment support. The below-ground additions have been carried out in relative secrecy.

The Mansion has been extensively remodeled several times, including being moved 35 feet back from the Fifth Avenue property line (to allow for a new hydraulic elevator system, which was needed to allow further construction below ground).

QUINJET ARRESTING
HOOK WIRE DEPLOY HATCH

AVENGERS
DEN/STUDY
INFORMAL
DE-BRIEFING
ROOM

CIRCULAR
STAIRCASE
UP

TONY STARK'S
MANHATTAN OFFICE

WORKSHOP/
PROTO-TYPE
DISPLAY
AREA

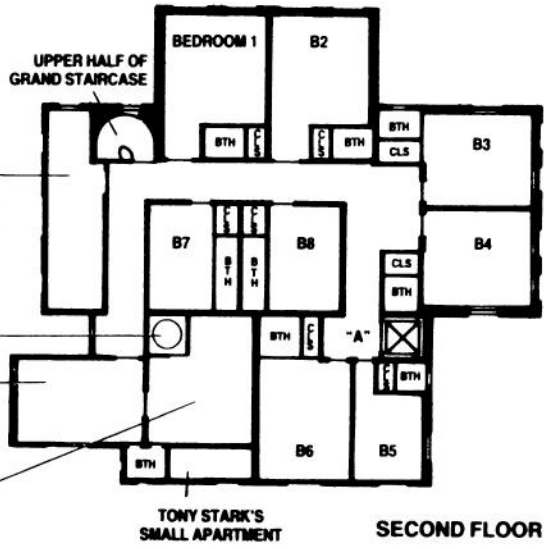

0 25 50 75 100

"CLS" = CLOSET
"BTH" = BATHROOM

THIRD FLOOR

The top floor of Avengers Mansion had long been the hangar and landing runway of the Avengers supersonic Quinjets (see *Avengers Quinjet*). Employing the principles of a naval aircraft carrier landing deck, the third floor uses a wire (which catches the arresting hook of a Quinjet) and a series of pistol-coupled pulleys which gradually decelerate the craft over a 30-foot distance. The third floor also contained computerized navigation aid, radar and communications. The hangar had storage room for four Quinjets; three on storage dollies, and one in launch position. With the recent rescinding of launch privileges within city limits, the third floor hangar has been in disuse. All of the Quinjets have been moved offshore to Hydrobase (see *Hydrobase*). Various members have suggested converting the facilities to other uses, but as yet what to do with the vacant hangar has not been decided.

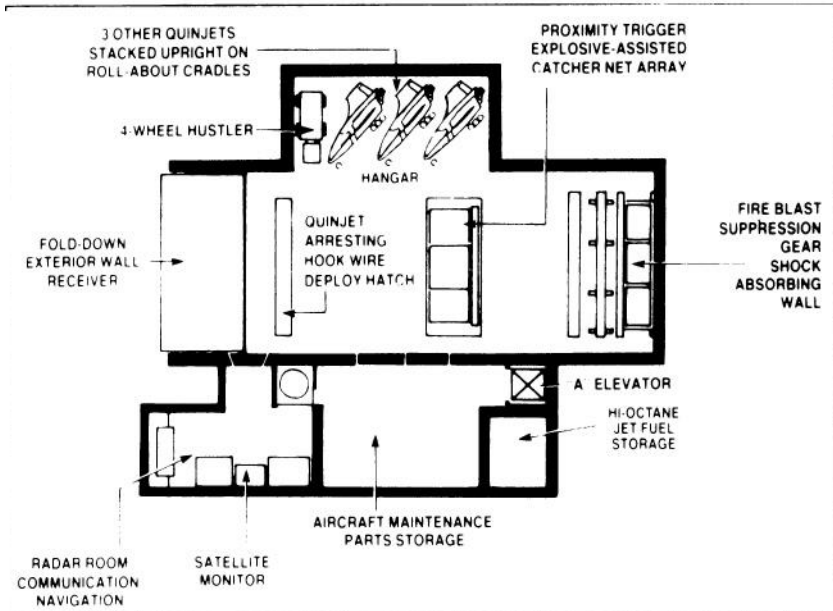

SECOND FLOOR

Private quarters for any Avenger who requests them comprise the entire second floor of the mansion. Unlike the third floor which was completely gutted to make room for the hangar facility, the second floor closely resembled the original floorplan and architecture designed and constructed by Howard Stark. While many members of the Avengers maintain residences outside the mansion, many members over the years have lived at the mansion full-time during their term of active membership. When space was available, a member such as the Wasp, who had a residence elsewhere, could use one of the bedrooms as a Manhattan apartment. Only one time in Avengers history were all eight bedrooms occupied. Usually, at least half of the rooms remain vacant. Since the Avengers inception, there has always been at least one Avenger living full time at the mansion. The following Avengers are the only ones never to have resided at Avengers Mansion: Iron Man, Hulk, Black Widow, Moondragon, Hellcat, Ms. Marvel, Falcon, and Captain Marvel. Anthony Stark's quarters, used infrequently by the Avengers benefactor and never as his alter ego Iron Man, are still reserved for Stark's exclusive use.

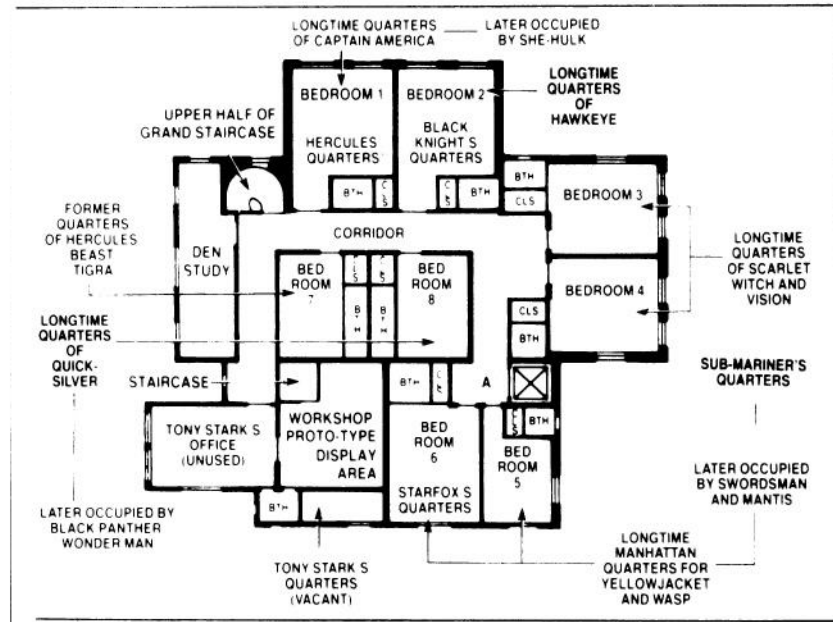

GROUNDS AND MAIN FLOOR

Avengers Mansion is surrounded on three sides by a twelve-foot high concrete and reinforced steel wall, with a steel fence down Fifth Avenue. The yard, doors, and windows all have numerous surveillance systems to ascertain the identities of all visitors and detainment devices to intercept unauthorized personnel. Visitors seeking entrance to the mansion are screened at the front gate. The garden and patio in the backyard have sufficient foliage to afford Avengers a fair degree of outdoor privacy. The main floor of the mansion contains no materials vital to the Avengers security or functions and thus is occasionally opened to the public for press conferences and social functions. The Avengers' only dining facilities are on the main floor, as is the private library. The Avengers butler Edwin Jarvis is the only person quartered on this floor.

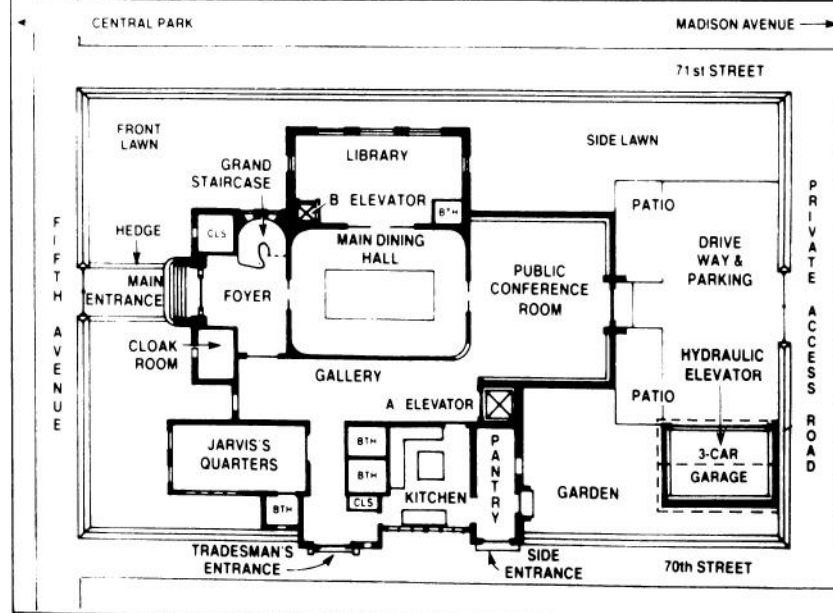

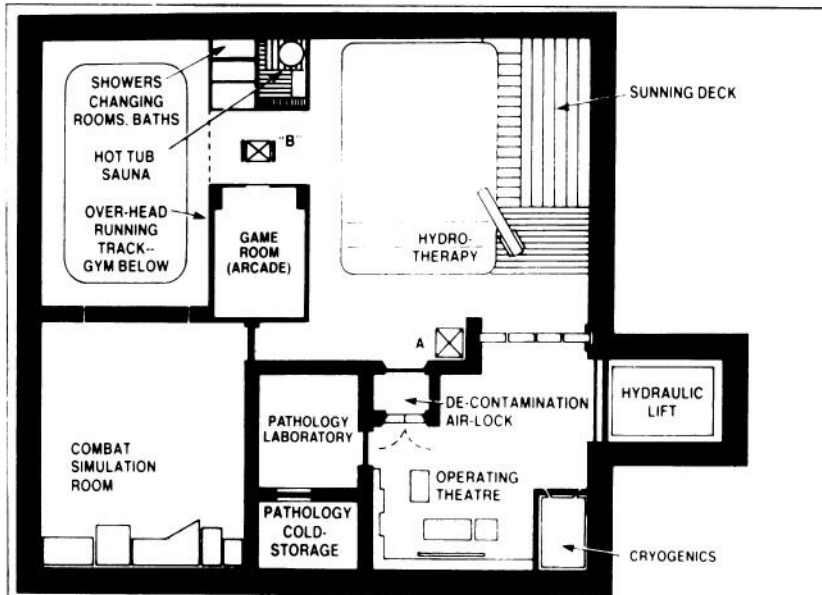

BASEMENT

Recreational, training, and medical facilities comprise the first Sub-surface level of Avengers Mansion. A fully equipped gymnasium, an Olympic size pool, sauna, and steambath are available to the membership, as is a game room featuring a billiards table, pinball machines, and video arcade games. The Combat Simulation Room is a heavily reinforced area, in which various robotic devices simulating humanoid and mechanical attacks can be engaged for training purposes. The Combat Room is monitored and programmed by the mansion's main computer system. Also on this level are emergency medical facilities once used by Dr. Donald Blake and Dr. Henry Pym. There is also a cryogenic storage area in which certain individuals (members or adversaries) suffering from degenerative ailments can be placed in suspended animation.

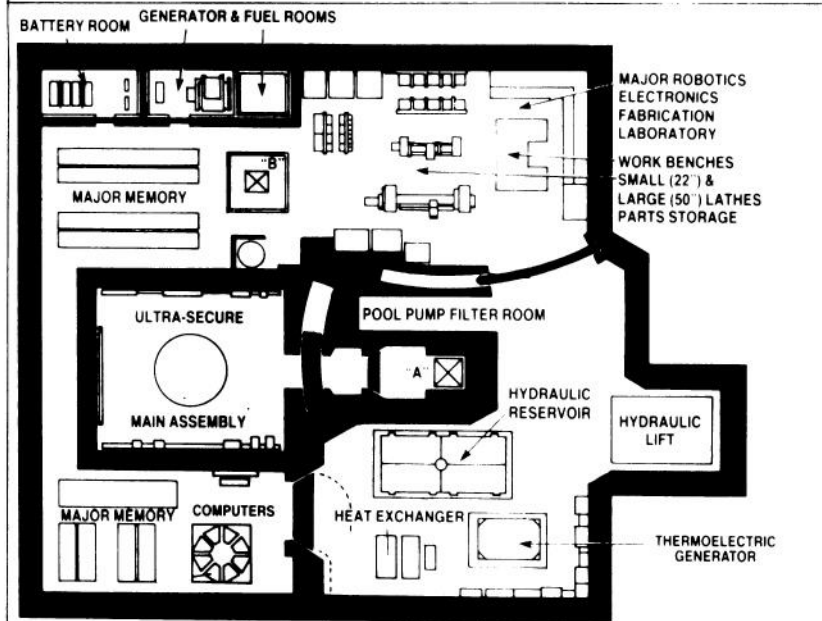

SUB-BASEMENT LEVEL ONE

Sub Basement Level One contains the Avengers high security Assembly Room where all operational meetings are held. The Assembly Room is the most secure place in the entire headquarters complex due to its massive reinforcements and vault like entrance passageway. The first sub-basement houses the Avengers computer system which contains all of their crime / forensic files, operational records and world security data.

Until recently when the Avengers governmental security clearances were revoked, the Avengers computers had limited access to the national security data of the Pentagon's computer system, as well as a direct common database with SHIELD. Now the only outside agency with which the Avengers routinely trade information is the Fantastic Four, Inc. The mansion's power supply, a thermoelectric generator, along with its attendant back-up systems, are also housed on this floor, as is the Robotics / Electronics Fabrication Area once used by Dr Henry Pym and Anthony Stark. This area is currently used by Dane Whitman (the Black Knight).

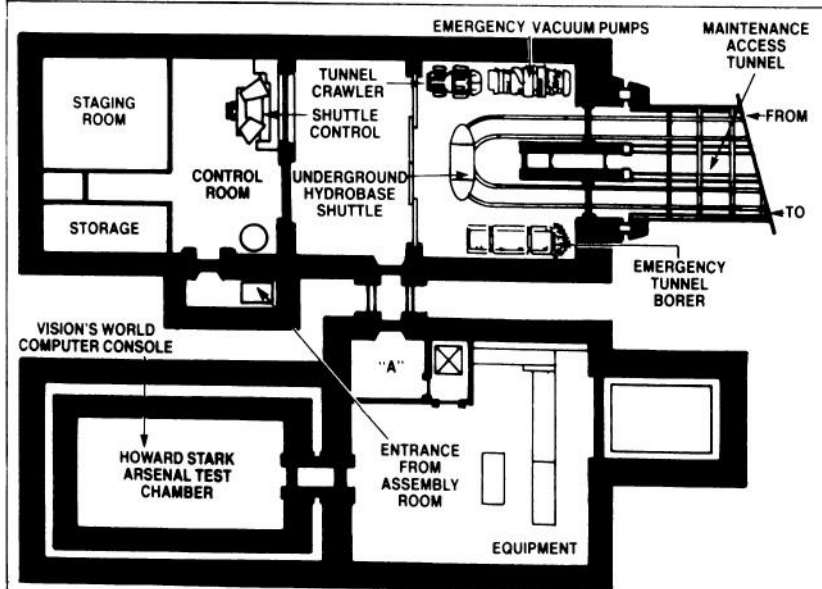

SUB-BASEMENT LEVEL TWO

Until recently, Sub-Basement Level Two had been primarily used for storage. Howard Stark built it for private weapons testing and storage, and constructed the robot named Arsenal there that would later menace the Avengers. The Avengers have a submarine pen with it's own waterway to the East River, but with the adoption of the Quinjets as the major means of transit, the submarine system fell into disuse. In recent months, the submarine pen and waterway has been refurbished to create the UGABS (Underground Airbase Shuttle) system, a secret means of rapid transit to the Hydrobase nine miles off the coast of New York. The shuttle is easily accessible from the Assembly Room above, as well as other parts of the Mansion.



Avengers' Compound

The West Coast Avengers headquarters is located at 1800 Palos Verdes Drive, south of Los Angeles California. The 15-acre estate was built in 1921 for movie star Sylvia Powell. After her death, the mansion was vacant for 15 years—probably no one wanted to pay the cost of owning and maintaining such a residence. However, money is no object to the Maria Stark Foundation, and the Powell estate was an ideal location for the West Coast Avengers.

The Powell estate required more extensive modifications than Howard Stark's Manhattan mansion, and the work was performed by technicians personally chosen by Tony Stark. As with the New York headquarters, the Avengers Pacific compound has most important facilities underground, while the above-ground buildings are lavishly-furnished living quarters.

Compound Grounds

The grounds are surrounded by a normal fence. The lawn is quite large, and a large part of it is used as an outdoor training area. The rest of the lawn includes various sensor systems (see *Security Systems*).

Five bungalows are scattered across the grounds, each given a measure of privacy by surrounding trees. A garage and a hangar are located in separate buildings on the grounds. A tennis court is part of the grounds.

The cliff on the seaward side slopes sharply to a private beach at the bottom, which is reached by wooden stairs.

Garage

This is an eight-car facility, with an elevator that connects to an automated repair shop underground. A tunnel connects the auto repair shop with the underground hangar.

Hangar

This is a two-level facility, with an attached outdoor helipad for helicopters or Vertical Take Off and Landing (VTOL) aircraft. The two levels of the hangar are connected by elevators, one for people, one for aircraft. Three skymobiles are stored in the upper level.

The lower level has room for four Quinjets (three in maintenance bays, one on the catapult). This level also includes a hangar maintenance bay, two firefighting robots in separate bays, and an aircraft carrier-style take-off and landing system with catapult. The hangar door folds upward and is camouflaged to look like part of the cliffside.

Bungalows

When built, these were servant's quarters. They have been completely remodeled as living quarters for Avengers members. Wonder Man, Tigra, Iron Man, and Henry Pym have individual bungalows. There is one vacant bungalow for guests.

Main House, Ground Floor

This floor includes a living room and lower library in the west wing. The main entrance, two galleries, the main staircase, the kitchen, two elevators, and two servant's quarters are in the central part of the house. The east wing holds a formal dining room and a ballroom (also used for press conferences). The sun deck and Olympic-size pool are behind the house.

The walls, floor, and ceiling are built of Remarkable strength material. The windows and doors are of Excellent strength material. The ground floor is a low-security area, but the elevators can be sealed to prevent access to the underground sub-basement levels.

Second Floor

The west wing contains an office/study and the upper level of the library. The central section of the house includes two lounge areas, the upper part of the main staircase, and balconies that overlook the ground floor. The east wing contains the master bedroom (used by Hawkeye and Mockingbird) and a recreation room.

The walls and floor are of Remarkable strength material. The windows and doors are of Excellent strength material. The roof and ceiling are Incredible strength material.

Basement

This level contains a workshop, storage, laundry, water heater, fuel storage, household computer, and back-up generator. In addition to the elevators, a staircase connects the basement with the kitchen above. Like the house above, the basement contains no vital functions and is a relatively low-security level.

Sub-Basement One

This level is primarily devoted to medical facilities, which are more elaborate than the counterpart facilities in the East Coast mansion. The level includes an operating room, surgical preparation/scrub room, a biochemistry laboratory, and a medical staging room. The entrances to these medical facilities are all airlocks, to maintain sterility and isolate any experimental mishaps.

Remaining facilities include a communication room, storage, a combined kitchen/pantry, a hospital recovery room, and a life support chamber that incorporates cryogenic technology for patients in critical

condition. The comprehensiveness of the medical facilities is a grim testimonial to the risks of a hero's career.

The walls, floor, and ceiling are of Amazing strength material. Doors are Incredible material, except for airlock doors, which are Amazing material.

Sub-Basement Two

This is the maximum-security area of Avengers' Compound, containing the most critical facilities.

The assembly room, main computer, data files, and power generator are the equal of their counterparts in the East Coast mansion, with complete backup installations in case of equipment failure.

The walls, floor, and ceiling are of Amazing strength material, except for those of the assembly room, which are of Monstrous strength material. Doors have the same strength material as the walls.

The computer systems and data files of the New York and California headquarters are constantly linked and share all information. The computers and files of the two main headquarters are also linked with the computers of Hydrobase, and those used by any experimental teams like the AEF.

The main differences between the New York and California headquarters are that the California compound has no danger room (the Avengers practice on the lawn) and that the California team can base their Quintets on site because the compound is more isolated than the Manhattan mansion.

AVENGERS COMPOUND

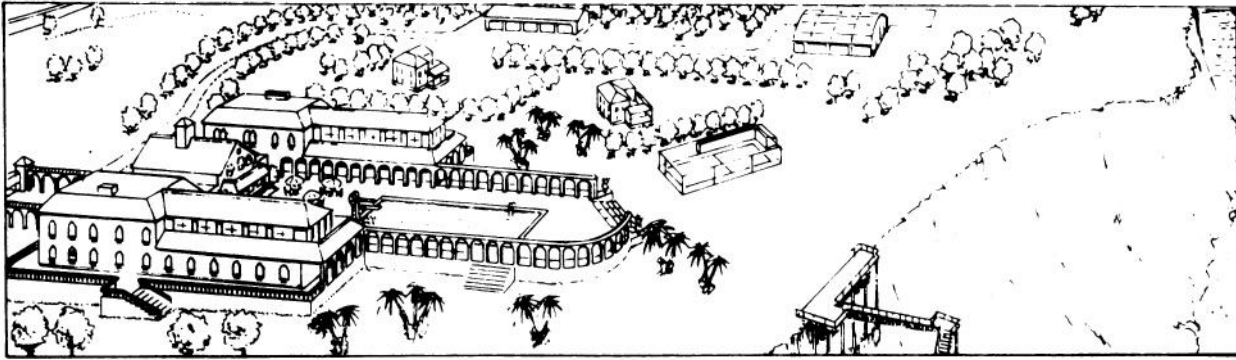

The Avengers Compound is a 15 acre estate located on the Pacific coastline south of Los Angeles at 1800 Palos Verdes Drive. It is the headquarters of the West Coast Avengers. Built in 1921 as a home for the silent movie star Sylvia Powell, the estate remained unoccupied since the actress's death in 1969 until it was purchased by the Avengers as a base for their second team. Based on designs created by Anthony Stark for the East Coast Avengers Mansion and for his former facilities at Stark International, the Compound's planning and construction was supervised by Dr. William Barrett Foster, an engineer formerly of Stark International's Los Angeles plant. A special freelance construction crew handpicked by Foster was contracted to do the building renovations. The mountainside beneath the main building was excavated to facilitate the installation of two levels about fifty feet beneath the mansion's basement. It is on these levels where the high security functions of the West Coast Avengers are conducted. A garage and hangar facility for the supersonic Quinjets was built on the site of a private four-hole golf course. The actual hangar facilities are underground, and are accessible through a camouflaged area of cliffside. The servants bungalows of the original estate were remodeled to become quarters for all members in residence. The estate includes about 250 feet of private beachfront. The Avengers Compound has a permanent staff of five, including a butler, maid, cook, groundskeeper, and mechanic. The financing and maintenance of the Compound is made possible through the Maria Stark Trust Fund and several private grants

FRONT VIEW



BACK VIEW



First appearance AVENGERS #246

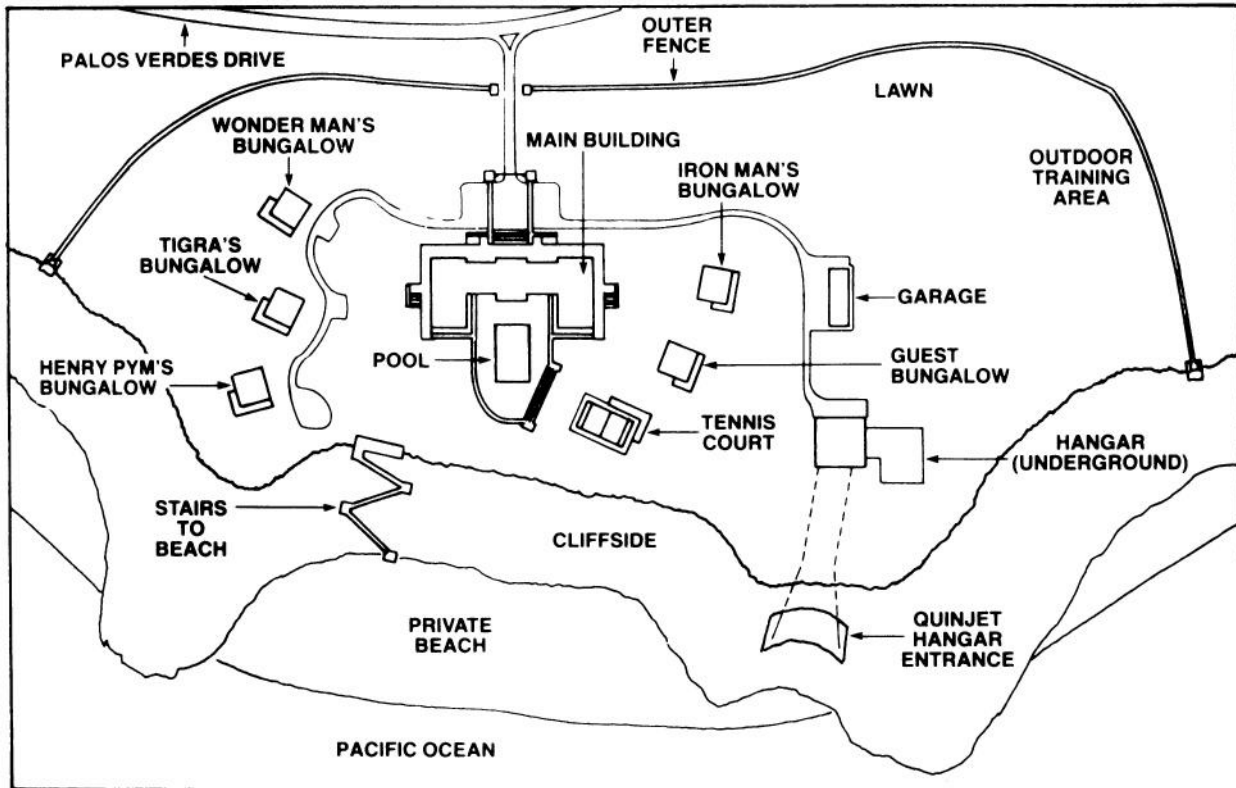

MAIN FLOOR

The Main Floor of the neo-Mediterranean styled villa retains most of its original functions and furnishings. Although there are numerous surveillance and detainment devices to intercept unauthorized personnel, this floor is relatively low security. Public functions of the Avengers, such as press conferences, are held in the east wing main ballroom, as is formal dining. Informal meetings are held in the west wing living room area. The library, which encompasses part of the second floor, has the capacity for 20,000 books. The kitchen and maid's and cook's quarters are also on this floor. On the same level as the Main Floor is the patio, sundeck, and Olympic size swimming pool.

SECOND FLOOR

The Second Floor of the main building contains the office / study where administrative affairs of the Avengers are conducted and non-classified organizational material is stored. This room is primarily used by the West Coast Avengers' chairman, Hawkeye. Also on this floor is the master bedroom shared by Hawkeye and his wife Mockingbird. In the west wing is the indoor recreation room and lounge where a billiards table, pinball machines, video arcades, and a wall-sized television screen are kept for the use of members and their guests. The second floor of the library contains fiction and recreational material, while the main floor of the library contains reference books. Second floor interior balconies overlook the front hall and both wings

BASEMENT

The Basement of the main building contains the conventional support facilities for the above ground levels, including the heating system, the power generators, and the house computer. It is a low security area.

SUB-BASEMENT LEVEL ONE

The two Sub-levels of the Avengers Compound are the high-security areas of the headquarters. On Level One is the private hospital and biological and chemical research facilities. As yet the Avengers employ no on-staff physician. Staff scientist Dr. Henry Pym makes use of the laboratory facilities.

SUB-BASEMENT LEVEL TWO

Level Two houses the high security Assembly room where all operational and strategic meetings are held. The main computer is located here, containing the same crime forensic files, operational records, and world security data as its twin in the East Coast Avengers Mansion. The computers are constantly on line with one another, sharing all data. Like the East Coast Avengers, the West Coast Avengers have limited access to the national security data of the Pentagon and SHIELD. Both East and West Coast Avengers routinely trade information with the Fantastic Four Inc. The power generators for the two Sub-Basement levels are located here.

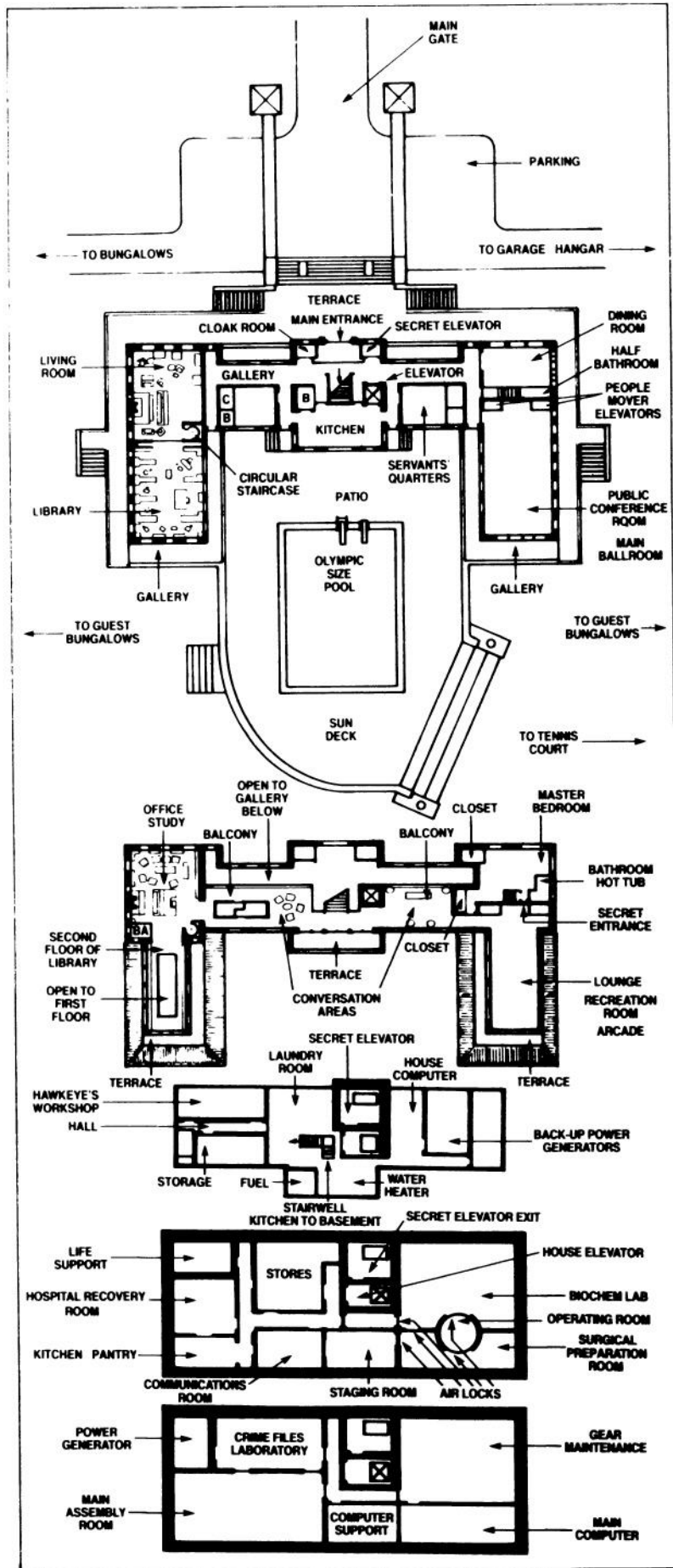

ABOVE GROUND LEVEL

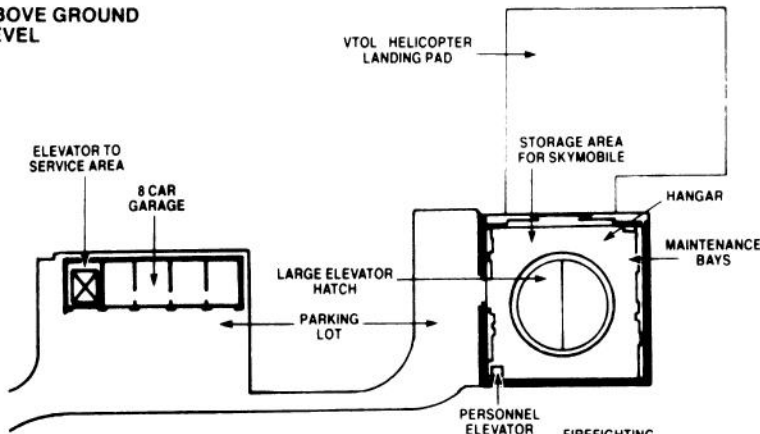

HANGAR

The Hangar Garage facility is separated from the Main Building of the Compound by about one hundred feet. Above ground is an eight car garage and a hangar facility for visiting helicopters and other VTOL or hovercraft type vehicles. Hawkeye's Skymobile is stored here (see *Hawkeye's Skymobile*). There is no runway for the landing of conventional aircraft. Beneath the garage is the automobile service area. Beneath the upper hangar is the main quinjet launch, landing, storage, and maintenance facility. There is room for four quinjets, three in the maintenance bays, one on the catapult launcher. The entrance to the underground hangar is disguised as part of the cliffside and can be opened remotely by each quinjet. The Hangar Garage facility and all West Coast Avengers vehicles are serviced by resident mechanic Jorge Latham, a friend of Hawkeye's, formerly of Cross Technological Enterprises.

BELOW GROUND LEVEL

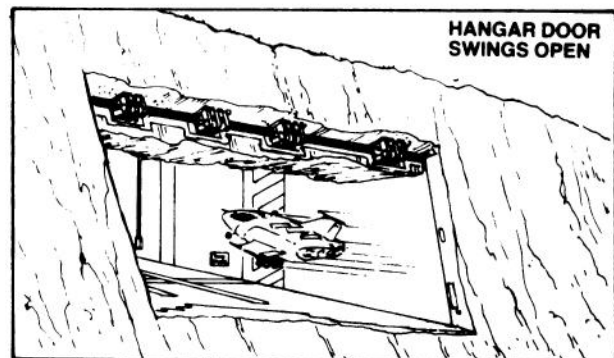
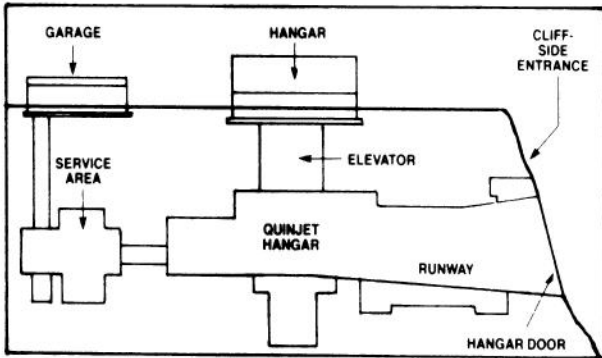
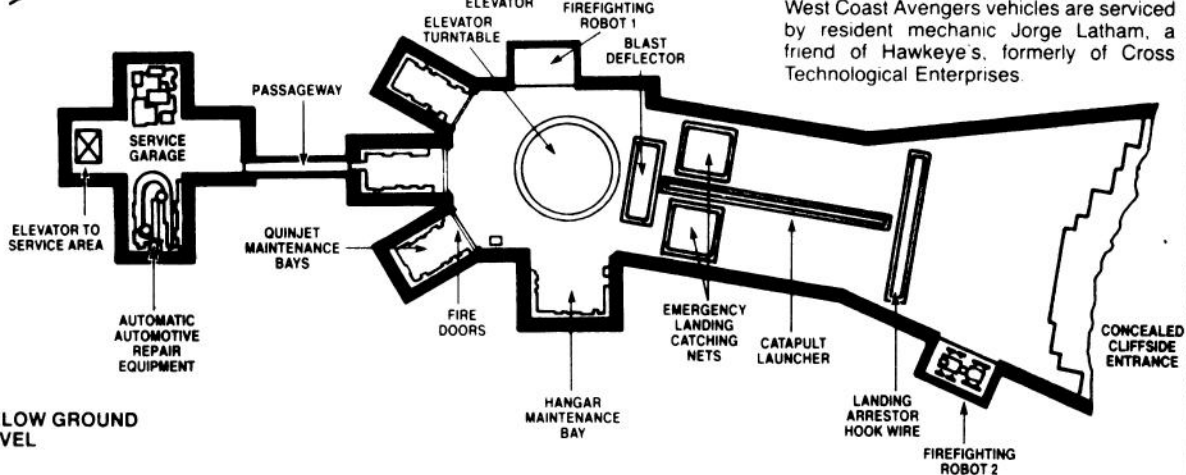

BUNGALOW

The Avengers Compound has five identical bungalows designed as living quarters for active members who request them.

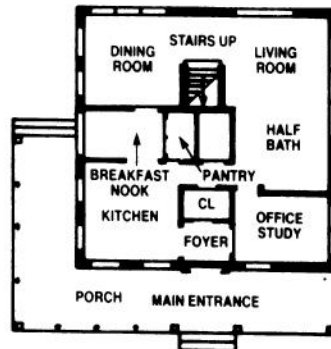

FIRST FLOOR

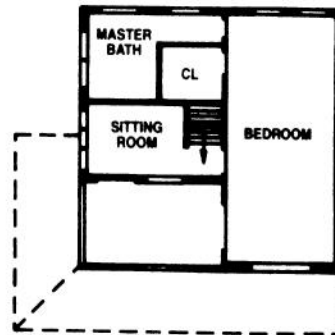

SECOND FLOOR

Security Systems

The two main Avengers HQs are as well-protected as any two buildings on Earth. However, by definition, any opponent who would attack an Avengers headquarters is a world-class threat, dangerous beyond the capacity of any security system (assuming, of course that the attacker is not a complete idiot with no idea of what he is getting himself into; see Fabian Stankowicz in the roster section). Avengers HQs have been assaulted by aliens, monsters, despots, super-villains, angry crowds, idiots (see above), and Dracula's mesmerized horde of cultists, winos, and vermin (human and animal types), among others.

Avengers security systems are always non-lethal, designed to capture and immobilize the threat with a minimum degree of injury. They are sophisticated enough to avoid attacking non-superhuman NPCs who pose no threat to the Avengers and are not attempting to violate security, although the presence of innocent NPCs will always be noted if they run afoul of a security sensor). All security and defense systems are tied into the Avengers main computer system and can be overridden by the Avenger on monitor duty. If events require that all Avengers leave the HQ, Edwin Jarvis (in New York) or Henry Pym (in Los Angeles) will man the monitor. Expansion teams like the AEF will have to make their own arrangements. Under normal circumstances, the monitor must always be manned (you never know when the President might call).

Security Package, Outdoors

(Incredible cost, covers five areas each)
This consists of sensors buried in lawns, hedges, trees, and fences to ensure full coverage of all outside grounds. These sensors provide full-body scan of an intruder. Threats automatically activate the defense system and sound an alert at the monitor. Threats are categorized with the following priorities:

- Identified enemies of the Avengers (this category includes anyone actually in combat with an Avenger or vandalizing Avengers property whether or not the threat is previously identified).
- Identified enemies of friendly contacts.
- Wanted criminals and fugitives from the law.
- Any dead possessing superhuman powers, including beings with battlesuits or other high-tech weapons.
- Any armed being, including armed robots
- Any energy source, radiation source, toxin, gas, corrosive, or hazardous chemical of Amazing rank or intensity.
- Natural disasters

The presence of non threatening intruders sounds an alert at the monitor but does not activate the defense system.

Defense Package, Outdoors

(Incredible cost, covers five areas each).
These are activated by the security package and are linked to the sensors. This package also includes a television camera system linked with the Avengers monitor. The defense response is listed by priorities, from most serious to least serious. The system starts from the bottom of the list, allowing for escalation of response. A successful red FEAT roll (Incredible intensity) allows two responses per round, otherwise one occurs). An Avenger on monitor duty can override the priority list selecting a higher degree of response.

1. Headquarters-wide alert, summoning all Avengers for immediate action.
2. Automated stunnulators (Range, 5 areas; intensity Excellent; aimed with Excellent Agility and Marksman talent; effects all in target area).
3. Pop-up detention tentacles (Range, 5 areas; Incredible strength material; grappling attack with Incredible Strength).
4. Pop-up canister launcher, detention net in canister (Launcher range, 5 areas; net covers 1 area; Launcher aims with Excellent Agility and Marksman talent; Remarkable strength material net).
5. Chemical-neutralizing or fire extinguishing foam (covers 5 areas; Remarkable intensity).

Low Security Package, Indoors

(Excellent cost; covers one door, window, or area, requires no space). This includes a burglar alarm and a mechanical lock. An alert sounds at the monitor and the monitor can display a map of the mansion showing the affected alarm. This is used in all low-security areas and in living quarters.

Medium Security Package, Indoors

(Remarkable cost; covers one room). This has all the capabilities of the low-security package plus television scan of room, auto-locks on all windows and exits. Locks can be opened by Avengers ID card or by Avengers voice-print (for quick response). This package can activate the defense system. This system is used in the Avengers Mansion basement (except for the medical facilities), Avengers Compound basement, garages, hangar, all Quinjets, and all elevators.

High-Security Package, Indoors

(Incredible cost; covers one room) This combines the capabilities of the previous two packages and adds constant auto lock on all exits until opened, full-room scans for unauthorized listening devices, full-body scans of all in the room, auto-scans for presence of infection, gas, toxins, or radiation, with auto-sealed environment to prevent entry or spread of contamination, and pressure-sensitive sensors in floor, ceiling, and walls. This package is used in all sub-basements, exterior doors and roof entrances, and in all medical facilities.

All indoor security packages use the same threat priorities as the outdoor security package.

Defense Package, Indoors

(Incredible cost). This is not as complex as the outdoor package. It consists of automated stunnulators in all medium and high-security rooms. The Avengers do not use entanglers, nets, gas traps, or other devices that might hinder their ability to deal with a foe directly. Any foe who penetrates a medium- or high-security area will confront the Avengers themselves.

Interior stunnulators (Range 2 areas: Amazing Intensity; aimed with Remarkable Agility and Marksman talent; affects all in target area).

Fire Protection

The Avengers use multiple packages of varying intensities: Excellent in low-security rooms, Remarkable in medium-security rooms, Amazing in high security rooms and in hangar facilities. Each package can cover up to 10 rooms.

Imprisonment Facilities

(Remarkable cost). The Avengers have a detention facility that uses Incredible strength material physical restraints and Excellent inhibitor devices. They can get a cell or other device of Class 1000 strength material by having Tony Stark build something made of True Adamantium. As a general rule, it is inconvenient for the Avengers to imprison someone for an extended period; they will do so only if they have no other choice or if asked to do so by the proper legal authorities.

THE AVENGERS QUINJET

The Quinjet is the Avengers' primary means of transportation, and the current design has served them well for many years. Each team operates four Quinjets, of which at least three are always in air-worthy condition. One of these is kept fueled and ready for immediate takeoff. The East Coast Avengers Quinjet facility is Hydrobase, 9 miles from the coast. The West Coast Avengers operate their Quinjets directly from the Avengers Compound.

The Basics. A Quintet has the following characteristics

Control Rm	Speed Sh Y	Body Ex	Protection Gd
---------------	---------------	------------	------------------

The Avengers also maintain a Quinjet capable of making lunar round-trip, but this craft is seldom used. The characteristics of the Lunar Quinjet are increased by +1 CS in all categories.

The Quinjet carries a crew of two and up to five additional passengers.

The Quintet has a maximum range of 11,000 miles and a normal range of 9,000 miles. The Avengers' security clearances entitle them to refueling and landing rights at its airbases abroad, as well as over-flight privileges from most UN countries. As a result, there are few places in the world beyond the reach of a Quinjet.

VTOL Capabilities. Although a Quinjet normally is launched from a catapult or takes off from a normal runway, it is also capable of Vertical Take Off and Landing, by directing engine thrust through vertical deflectors. When taking off in this way, the Quinjet rises 14 stories on the ground it takes off. At that altitude, the thrust, re-routed for normal flight. This process is reversed for landing.

VTOL features give the Quinjet several other capabilities. When VTOL is used, the Quintet can climb or descend at full speed without the pilot having to make a Control FEAT roll. A sudden, controlled vertical jump is also useful for dodging missiles and other aircraft that cannot do the same (-2 CS in enemy FEAT rolls). VTOL also allows the Quinjet to hover.

Electronics. The Quinjet is equipped with the most advanced radar, navigational aids, and electronic counter-measure technology available. The Quinjet uses phased array pulse-doppler digital radar that spots targets at lower altitude and also provides a +2 CS to the Quintet pilot's Control FEAT rolls when the Quinjet is flying at unusually low altitudes. The ECM includes a radar warning detector of Monstrous accuracy, a radio and tele-guidance jammer of

Monstrous intensity, frequency-hopping radar to confuse homing missiles (-3 CS to missile Control FEATs). If all this fails, an Avenger will probably get out and pulverize the attacker (they lose too many Quinjets to super-baddies to afford to have one blasted by a missile).

The Quinjet's radio can receive all frequencies in international use, as well as the classified frequencies used by S.H.I.E.L.D. and other government agencies. It can also tap into the computers at Avengers headquarters and gain access to any of the information. Classified data is protected by a code of Monstrous complexity, to foil eavesdropping. The Quinjet's communication gear automatically decodes data when it is received

Auto-Pilot. The Quinjet has an automatic pilot capable of flying it with Typical control. It takes 1 round to set or to disengage the auto-pilot. The auto-pilot is not capable of handling take-off or landing, and any violent maneuvers are very risky.

Cargo Space. The Quinjet was designed as a passenger vehicle only, but a limited amount of cargo (apart from standard gear) can be carried if the passenger seats are removed, leaving only the crew seats. Approximately a half ton of cargo can be carried.

Safety Features. Because you can't be too careful, the Quinjet has a number of safety features. Back-ups for the navigation radar, compass, and radio are standard. To prevent fires, the Quinjet is equipped with an automated foam-dispensing system that has Excellent effect against flame. A number of hand-held extinguishers filled with the same foam are aboard. The fuel tanks are self-sealing, capable of handling bullets and shrapnel (Good protection against physical damage). The fuel tanks also have Excellent resistance to fire and heat. Protection for passengers includes the usual seat harness and oxygen mask. If the canopy is broken (Excellent strength material), a second canopy slides over it. Cabin pressure is then automatically restored. Parachutes are carried for the benefit of any non-superhuman passenger in the Quinjet - Avengers themselves do not usually use them. Inflatable life rafts may be carried for crash landings at sea. The Quinjet carries a comprehensive first-aid kit.

Avengers tradition requires that if a Quinjet is disabled and headed for a crash, a pilot stays aboard to do everything possible to prevent the Quintet from hitting people on the ground.

Medium-Security package. To prevent the theft of a Quintet, the Avengers take strong measures. The interior of the ship is electronically monitored via television scan. The canopy and hatch are protected by automatic locks on the hatch and canopy. Locks can be opened by Avengers ID card or by Avengers voiceprint (for quick response).

Temporary Modifications. Although the basic design of the Quinjet has remained unchanged for a long time, the Avengers frequently add minor features for testing purposes, then remove them if they have little or no value. For example, while the Quinjet hasn't floated too well lately, in the past the Quinjet has made at least one water landing, using inflatable pontoons. Players with Avengers characters should feel free to experiment with modifications.

A Note on Stealth. Although the East Coast team currently uses the Quinjet almost exclusively, the WCA skycycle used by Hawkeye and others does possess advantages when an Avenger wants to go undetected. A recent terrorist incident forced Captain America to use one. If such trends continue, the skycycle may become more widely used, or a "stealth Quinjet" may be developed.

EQUIPMENT AND LOCATIONS

Equipment

Bio-Analyzer

This device can detect the presence of mutants, aliens and shape-changers at a range of 10 areas. It can be programmed to track a specific known individual or specific racial type (such as Kree or dire wraiths) assuming that biological data on the individual or race is available. The Avengers loaned this device to Henry Gyrich when Gyrich tried to arrest Rogue after her attack on S.H.I.E.L.D.'s Helicarrier.

- van and motorcycle.
- Primary unit for on board computers is inside one large compartment.
- Fold-down bunk with air mattress.

terminal can be interfaced with the van's computer system, allowing him to record and analyze the information forwarded by the Stars and Stripes, the monitoring network for Captain America's Hotline.

The Hotline Link: Cap's briefcase computer

CAPTAIN AMERICA'S VAN

Captain America's Van

Control Gd	Speed Ex	Body Rm	Protection Ex
------------	----------	---------	---------------

The Body: These are notable features:

- The entire body, including roof and underpanel is armored.
- Extra thick frontal armor for ramming (Remarkable protection).
- Variable power headlights reduce intensity of smoke, haze, or fog by -4 CS.
- Solid tires have Good protection against physical damage, and are of Good strength material.
- Hydro-bumper negates impacts of Good strength or less.
- License plate roller includes business and private plates, as well as several states.
- Sign roller on the side holds several business signs, concealed by removable panel.
- Winch behind grill holds 50-foot cable of Incredible strength material.
- Two-way rear doors can open normally or be lowered as a ramp for the motorcycle.
- Gas cap has an Excellent strength lock.

The Controls: These are notable features:

- Computerized steering with TV periscope allows hands-off driving at -1 CS.
- Duplicate controls in glove compartment allow driving from either seat.
- On board computerized map file for highway and urban driving. Can be programmed to display a route or routes or a specific location with Remarkable ability.

The Interior: These are notable features:

- Automatic fire-extinguisher system dispenses Excellent intensity foam.
- Motorcycle can be driven directly out of inboard mount.
- Kitchen unit includes microwave oven, pantry, and sink with attached water tank.
- Two first aid kits, one standard, one automated.
- Automotive tool kit. with spare parts for both

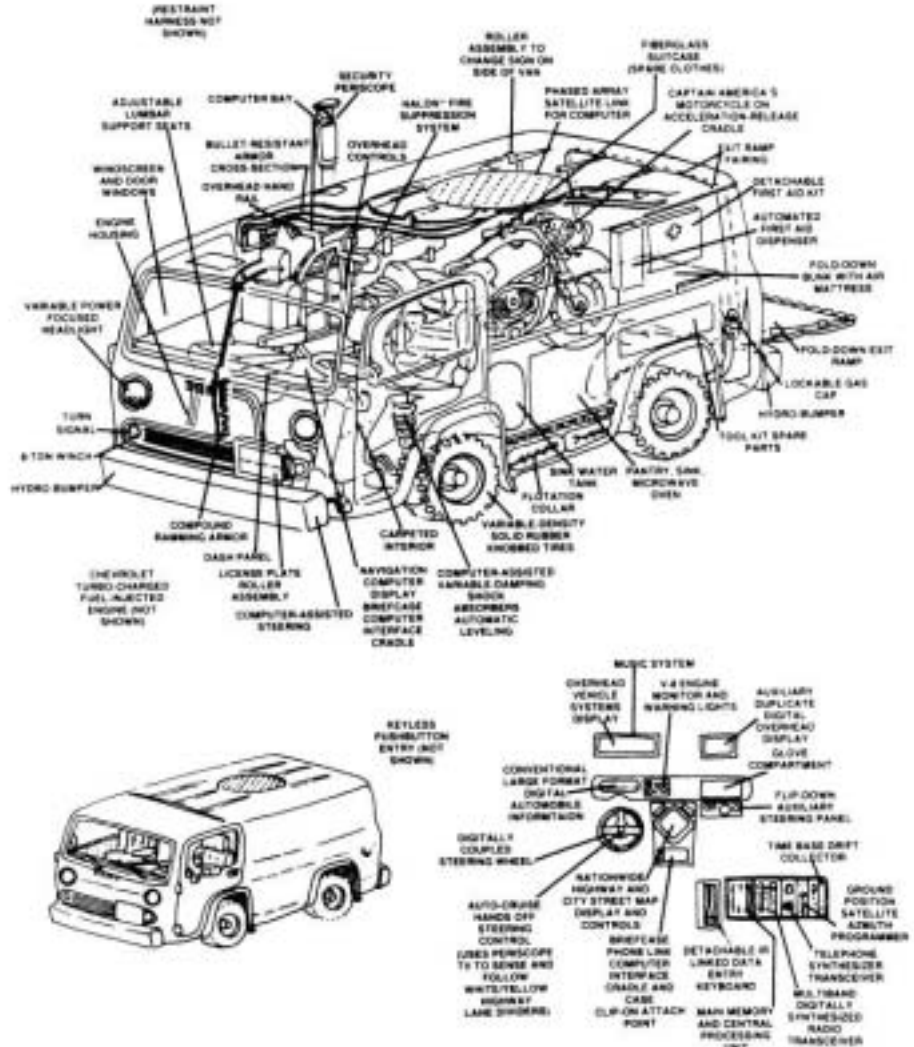

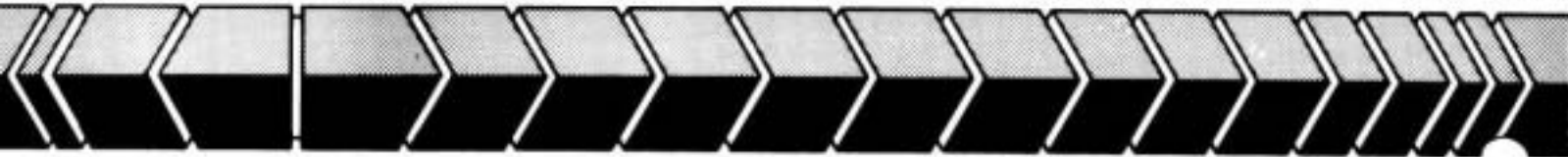

Image Inducer

No super hero headquarters should be without this. The Avengers have built them into all two-way visual monitors. The Inducer Transmits an image of a hero in costume, even when he really isn't. This is handy for those awkward emergency calls (the ones that pull you from the shower, for example).

Mutant Neutralizer

Forge's prototype mutant neutralizer was borrowed from the government by the Scarlet Witch who gave it to Tony Stark for analysis. It is therefore likely that Stark could build a copy of it and an anti-neutralizer may not be beyond his capability.

Tunnel Machines

In Sub-Basement Two at Avengers Mansion are two machines used to maintain the tunnel that connects to Hydrobase. The Tunnel Borer has the same stats as listed on page 48 of the Players Book. The Crawler has the following statistics:

Control	Speed	Body	Protection
Gd	Ty	Ex	Ex

The Crawler has a pair of mechanical arms that can be fitted with claws or with various excavation scoops; the arms lift with Incredible Strength. Both machines can be sealed and survive for 6 hours on an internal air supply (in the event the machine is caught in a catastrophic cave-in).

Wrist Communicator

This wristwatch-size radio/TV is worn by all Avengers on duty. It has an effective range of approximately 20 miles for broadcasting, but can receive at up to 250,000 miles (the distance from the Earth to the Moon) if the transmitter is powerful enough; this is effectively one-way communication. The only Avenger who does not use a communicator is Captain Marvel, who can be at the destination in person as quickly as a signal.

Locations of Importance

Trying to compile a comprehensive list of the weird, interesting, or dangerous places the Avengers have been over the years would be a brain-bending task. The following listed places share one characteristic-they either are or might be continuing sources of trouble for the Avengers and as such are excellent settings for game adventures.

Atlantis

This city-state, built on the ruins of the ancient surface city of the same name, holds the largest known population of *Homo mermani* in the world. Others live in various scattered settlements throughout the ocean. The Atlanteans lived through hard times in recent decades, but united behind the leadership of the Sub-Mariner, the rightful heir to Atlantis' throne. Namor did not rule well; his half-human, half-Atlantean nature, as well as his love for adventure, caused him to neglect his royal duties. The ruling council eventually judged Namor unfit to rule, and he abdicated. A civil war broke out in Atlantis, and when everything was sorted out, the barbarian tyrant Attuma ruled the kingdom. To discredit Namor (and lure him to his death), Attuma captured Namor's lover, a humanoid Plodex named Marrina. Marrina was becoming increasingly monstrous due to meeting another Plodex. Attuma's scheme backfired; Namor, the Avengers, and Alpha Flight combined to free Marrina. Many of Attuma's subjects deserted to live in Deluvia, Namor's new kingdom. Attuma can expect to lose dissident subjects as long as Deluvia exists, and will eventually have to attack it. When that happens, Namor may turn to the Avengers for aid.

Deluvia

This undersea kingdom, ruled by the Sub-Mariner and Marrina (formerly of Alpha Flight), is centered around Namor's villa in the mid-Atlantic Ocean. The inhabitants of Deluvia are Atlanteans who fled the tyrannical rule of Attuma, warlord of Atlantis. The Deluvians were led to the site by Prince Byrrah and Lord Vashti during Attuma's battle with Namor, the Avengers, and Alpha Flight. The heroes freed Marrina from Attuma's cruel imprisonment and she was reunited with Namor; the two have recently married. The exact location of Deluvia has not been revealed, but from maps showing "Namor's Solitary Place" the site may be close to 40 degrees W, 30 degrees S, Atlantis' location is 22 degrees W, 55 degrees N. Both locations are approximate, the sub-sea races try to keep their affairs secret from surface-dwellers. If Attuma learns of Deluvia's existence, it is likely that the malign monarch would mount an immediate attack.

Hydrobase

This camouflaged sea going vessel is the aircraft facility for the East Coast Avengers and the Fantastic Four. When their exemptions from Federal regulations were revoked by the FAA, the heroes leased part of the vessel from its owners, Dr Walter Newell

(also known as Stingray) and his wife Diane Arliss. The exact size of Hydrobase is unknown, but since its longest runway can handle planes the size of jumbo jets, it must be at least 2 miles long and 1.25 miles wide. Hydrobase is largely automated and self-maintaining. Dr Newell has neither the training nor the time to perform maintenance himself. The vessel is covered with soil, trees, and sand to make it look like a small island. Hydrobase has a monitor system (located beneath the computer center) that can display any or all parts of the vessel on multiple screens. The vessel is defended by a variety of concealed automated weapons of Incredible power and range, usable against airborne or surface targets. In addition to the weapons, Hydrobase's defenses include Dr. Newell himself, using his winged Stingray armor.

Stingray

F	A	S	E	R	I	P
Gd	Rm	In	In	Ex	Gd	Gd

KNOWN POWERS

Body Armor - Remarkable
Resistances - Heat, Cold, Electricity
 (Amazing for all)
Water Breathing
Electro-Sting - Incredible intensity range 1 area
Swimming - Good speed
Gliding - Good

TALENTS: Underwater Combat, Oceanography, Ocean Life, Engineering

Dr Newell's wife Diane is the sister of the villain Tiger Shark.

Limbo

This extraspatial dimension is the home base of Immortus and his servant, the Space Phantom. The conspiracy that eliminated the divergent Kangs also operated from here. Actions taken here produce no divergent realities. All time exists here as a single moment and the passing of years elsewhere has no effect here. All time-eras are accessible from here and most practical time machines send their passengers through here to avoid accelerated aging. Limbo also has some connection to the "Limbo" to which the dire wraiths were banished; travel between the two is possible. Limbo is a murky, fog shrouded place in which the lack of landmarks causes one to be quickly lost. Though largely uninhabited, Limbo is dangerous because its master, Immortus, has vast power here, and because he is answerable to no one but himself.



NORAD

The North American Air Defense Command, located at Cheyenne Mountain, Colorado (code-named Valhalla), is responsible for protecting the continent from nuclear or space-borne attack. NORAD had a direct communication link with the Avengers, although their access to NORAD computer data is currently restricted. The frequency with which this base is attacked by superhuman beings must cause nightmares and premature aging among Air Force generals. The

Now-deceased Count Nefaria seized the mountain and tried to blackmail the government with the threat of nuclear holocaust. The X-Men heroically foiled this plot at the cost of an X-Man's life. Years later the X-Men returned and ransacked NORAD themselves, doing a fine imitation of major sabotage. The X-Men were actually rescuing an innocent hostage the Air Force didn't even know was there. The Air Force's aggressive belief that *no one* should be allowed to attack its fortress overwhelmed the X-Men's meager attempts at explanation ("who'd ever believe a

mutant?" etc.), and the X-Men left looking like traitors. Before NORAD could catch its breath, the Vision seized control of its computers, in a non-violent attempt to impose peace on the world. The Avengers accepted punitive government actions arising out of the Vision's misguided, but well-intentioned, efforts. NORAD is protected, in a rather ineffectual fashion (at least compared to the X-Men's power), by Secbots, defensively oriented battlesuited soldiers similar to S.H.I.E.L.D.'s Mandroids.

HYDRO-BASE

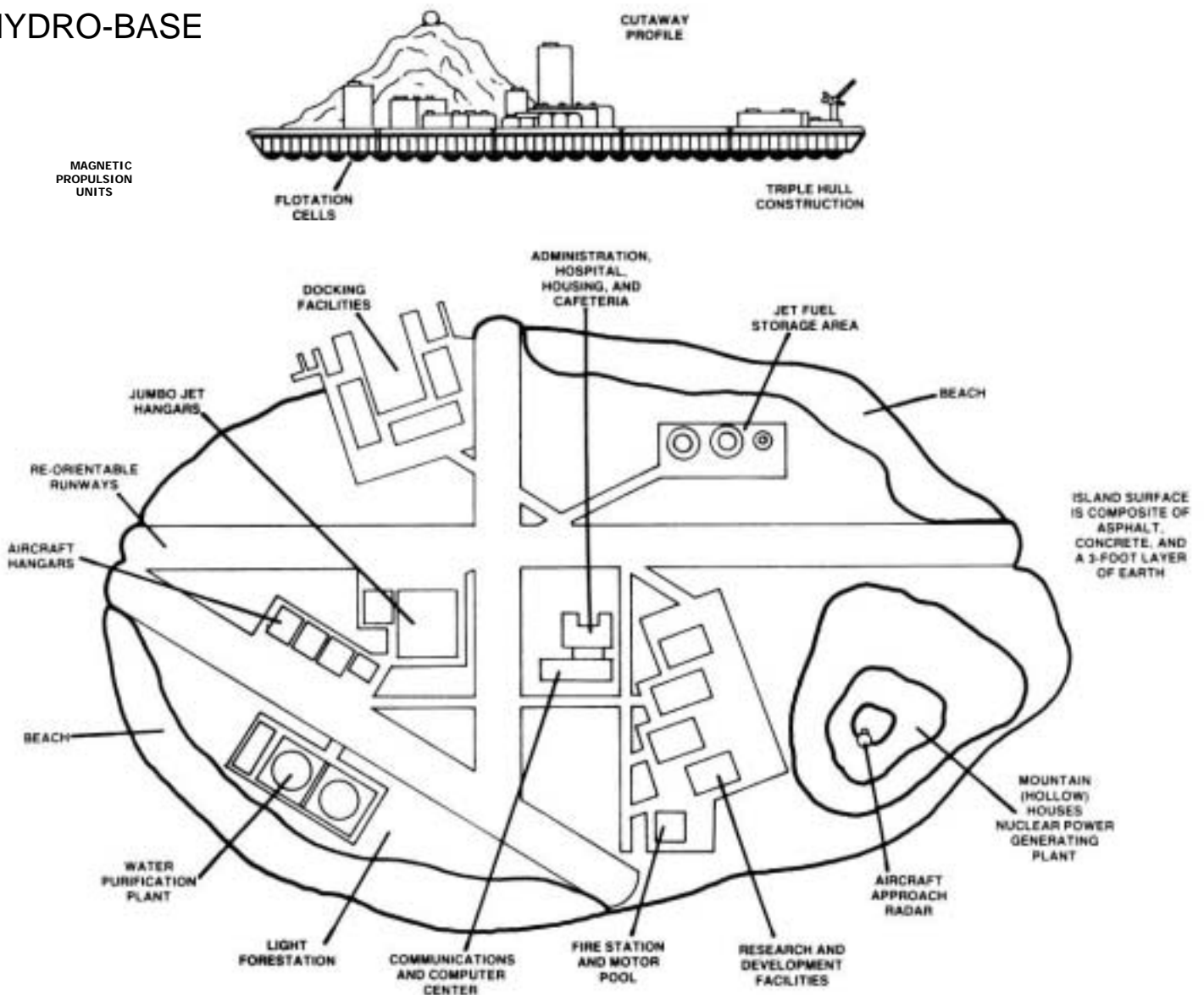

Project Pegasus

The Project was originally intended to conduct research into new energy sources. That vital work still goes on, but the scientists at the Project also studied (and in some cases imprisoned within the Compound) beings with superhuman powers, usually criminals with energy wielding powers. The use of Project Pegasus as a prison caused more trouble than anyone there could have anticipated, and this role has been abandoned.

Project Pegasus is located in the Catskill Mountains of upstate New York, and uses both surface and underground facilities. The surface facilities, not shown on the map, have recently been destroyed and are now being rebuilt. These include two geodesic domes used for supply storage, a multi-storied administration building with two wings, and two observatories; one with optical telescopes, the other with a radio telescope. The underground facilities are extensive. The central part, the Silo, has eight levels, with three stories each. The functions of each are

listed on the map. There are 14 spherical secondary labs and living quarters, 12 of which are connected directly with the Silo.

The entire complex is powered by a nuclear reactor, reactor waste is stored on-site Pegasus' energy research involves solar energy, cosmic rays, "cold" fission, magnetism, gravitics, nuclear waste, geothermal power, and formerly, superhuman bio-energies. The last two lines of study were the basis for Avengers involvement. The Project's "magma-tap," designed to reach deep into the Earth, accidentally breached the cavern of the formerly nomadic Lava Men, who attacked the Project in retaliation and almost destroyed the Project's nuclear reactor. The Avengers, assisted by Spider-Man, managed to turn back the attack and convinced the Lava Men that no harm was intended. During all this, the Avengers had to battle Moonstone, the Rhino, Blackout, and Electro, who were then imprisoned at the Project, but who escaped in the confusion. The magma-tap has since resumed drilling, in a different direction.

The second, even more serious incident, involved Iron Man. The Project had kidnapped Willie Evans Jr., a mutant child whose powers had been wreaking havoc. Willie's father, believing that X-Factor was responsible for the kidnapping, confronted them. X-Factor deduced that Willie was at the Project and decided to free him. At that time, Iron Man was helping the Project with research into solar energy. X-Factor was intercepted by Guardsman, the Project's security chief, and forced into battle. Iron Man went to Guardsman's aid. Shortly after Iron Man and Guardsman learned the truth, Willie broke free and destroyed the Project's surface level, critically injuring many of the Project's personnel. Iron Man and X-Factor pursued Willie, trying to help him, but he fatally injured himself while trying to bring his rampant powers under control. Shortly thereafter, the Project ended its research into superhuman powers and its service as a prison. All superhuman criminals currently in custody have been transferred to the Vault, and Guardsman now serves there as well.

PROJECT PEGASUS

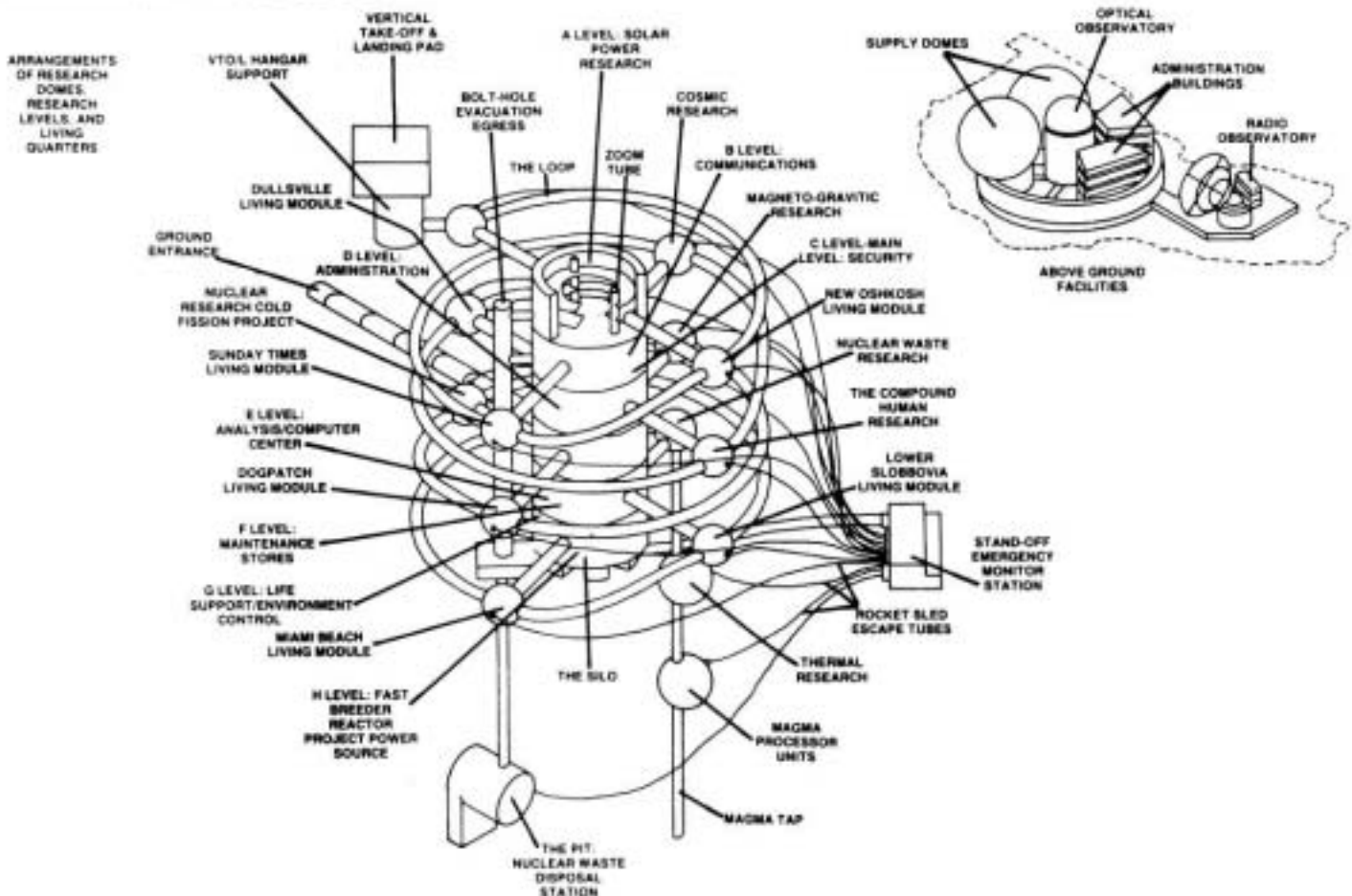



SAC

In the Marvel Universe, the Strategic Air Command shares control of the nation's land-based ICBM's with NORAD (The Air Force's Doomsday System, designed to launch missiles automatically in the event that all command authority was destroyed, was installed at NORAD, not SAC). SAC presumably has full command of the strategic bomber force. SAC has a direct communication link to Avengers headquarters, due to SAC's importance to the nation's defense. Certain vital strategic materials, like adamantium resins, are stored at the usually-secure SAC headquarters near Omaha, Nebraska. The now-deceased criminal mastermind Egghead, blackmailed Yellowjacket (Henry Pym) into helping him steal those resins, with the intention of building an invincible robot army. Pym did as commanded, but also used SAC's communication link to summon the Avengers. Egghead forced Pym to battle them, but Pym was defeated and accused of treason. Egghead was able to exploit this, but when the crisis was finally resolved, Egghead was dead and Pym was exonerated.

Titan

Saturn's largest moon (one of 19) was originally settled by a very small population of Eternals. A much larger population, which had lived on Uranus, was rash enough to destroy a Kree Sentry before heading back to Earth. Kree retaliation decimated the Eternals, and the survivors settled on Titan. They did not fare better there. Civil war almost exterminated them. One woman, Sui-San, still lived when Alars, an exile from Earth's Eternals, reached Titan. Alars took the name Mentor, and with Sui-San, he began the rebuilding and repopulating of Titan. Among the last of Mentor's many children were Thanos and Starfox. The full, gruesome life-history of Thanos is in the roster section, but he left nuclear devastation in his wake when he departed his homeworld, killing his mother among thousands of others. At its height, Titan had a population of 35,000; Thanos did his best to reduce this figure to zero. Mentor did what he could to defeat Thanos, and has been rebuilding Titan (for a second time) ever since. The population of Titan lives deep within the airless moon, and has used advanced technology to create an Earthlike environment.

The environment, and almost everything else, is maintained by ISSAC, a planetary computer with Unearthly Reason. ISSAC is willing to answer any problem put to it, by anyone. When Starfox, Mentor's adventurous and hedonistic son (also an Avenger), asked for help in repairing the then-paralyzed Vision, ISSAC provided it. Being in contact with ISSAC, a computer mind with far more capacity than his own, unhinged the Vision, and he concocted his plan to conquer the world by computer control. Fortunately, the Vision recognized his error and the Avengers ended the scheme.

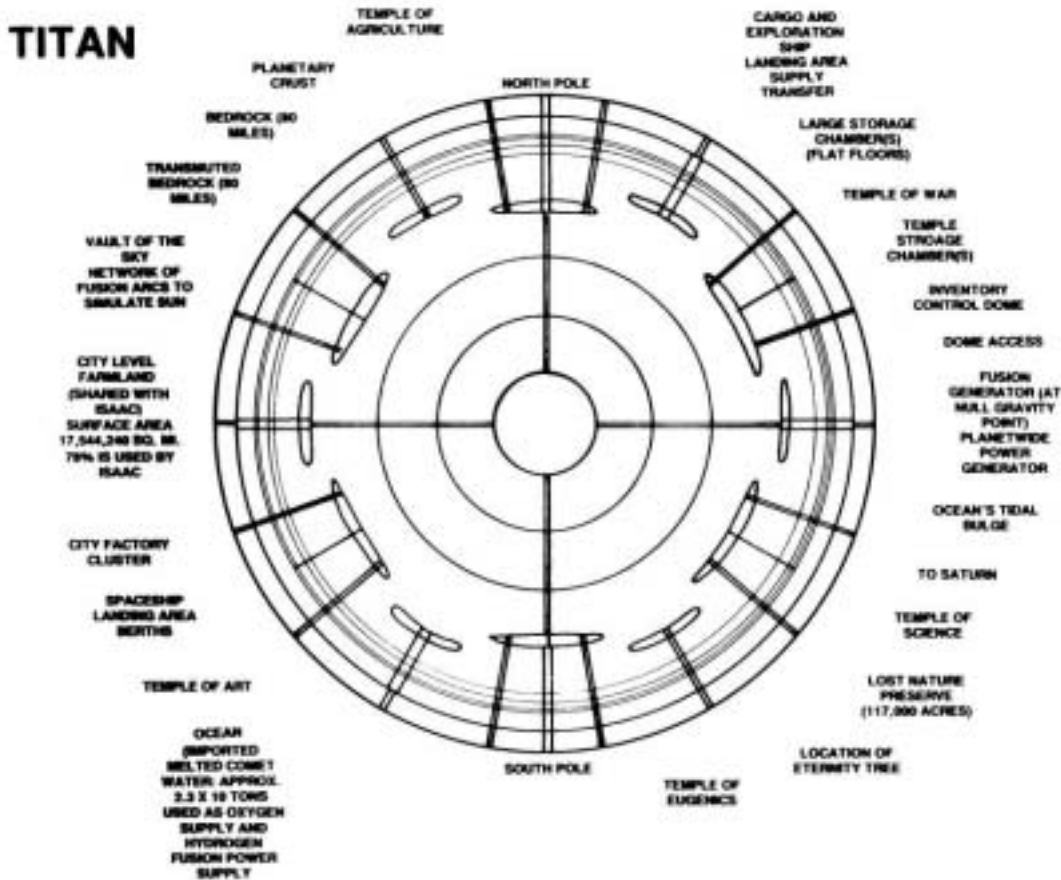



Transia/Wundagore Mountain

Transia is a mountainous micro-state in the Balkans, bordered by Bulgaria, Yugoslavia, Romania, and Transylvania. Although all its neighbors have Communist governments, the form of Transia's government is unrevealed. (Throughout history, similar rugged areas have fiercely opposed submission to any tyrant). Transia is well noted as the birthplace of the heroic Scarlet Witch and the until-recently heroic Quicksilver. Transia is a land of small, agricultural villages. Most Transians, have a superstitious fear of Wundagore Mountain, Transia's highest peak (Does anyone need to guess where in Transia Wanda and Pietro were born?).

In the 6th century A.D. Morgan Le Fey and her Darkholders (named after a book of evil magical spells and formulae written by the Elder Demon Chthon) tried to bring Chthon to Earth, but imprisoned him within Wundagore Mountain when he proved too powerful to control. In the 20th century A.D., the mountain was purchased by Herbert Wyndham, who later became the armored High Evolutionary. Wyndham was attracted by the mountain's uranium deposits, knowing nothing of its magical history. His assistant became possessed by the life-force of a virtuous Darkholder, Magnus, who trained the Evolutionary's New Men (sentient beings forcibly evolved from an animal origin) as knights of Wundagore. The Wundagorian knights were mounted on Atomic Steeds (one of which the Avenger Black Knight now rides). On the night of Wanda's and Pietro's birth, Chthon tried to escape from the mountain, but was driven back by Magnus, the knights, and the High Evolutionary (who have all since left the Earth). On that night, Chthon gave Wanda the potential for wielding true magic, in preparation for his next attempt at escape. When the attempt came, using Modred the Mystic as Chthon's agent and the Scarlet Witch as Chthon's host body, the demon failed; the Avengers drove the spirit of Chthon into a magical doll carved in the likeness of the Scarlet Witch. The doll was buried in the depths of the mountain when Wanda caused half of the mountain to collapse upon it. Though most of its mysteries have been revealed, Wundagore will remain an ominous name as long as the deathless Chthon endures.

The Vault

This is a newly-established prison intended to house only superhuman criminals. The Vault is located within the Rocky Mountains, and it was established because normal prisons were not secure enough and because installations like Project Pegasus were too valuable for other purposes to be used as prisons. The Avengers teams, East Coast and West Coast, were the first prisoners kept here (and very securely, too), on the basis of perjured testimony. The Second Brotherhood of Evil Mutants (alias Freedom Force) originally captured the Avengers, but Spider-Woman, a member of Freedom Force, helped release them from the Vault. The Avengers later managed to exonerate themselves, and were cleared of all charges. Many true criminals who would have been transferred here from other prisons, were freed en route by agents of Baron Zero, and recruited for the fourth Masters of Evil. The security force at the Vault wears armor that is similar to the Guardsman armor worn by Iron Man's friend and associate Michael O'Brian. The armor worn by the rank-and-file is not as powerful as O'Brian's, but is identical in appearance.

Guardsman (Michael O'Brian)

F	A	S	E	R	I	P
Ex	Ex	Am	Am	Gd	Gd	Gd

KNOWN POWERS

- Body Armor* - Incredible versus physical attacks, Excellent versus energy attacks
- Resistance* - Radiation (Monstrous)
- Flight* - Excellent speed
- Repulsors* - Incredible Energy beam, range 5 areas
- Air Supply* - Duration 1 hour
- Protected Senses* - Vision and Hearing (Remarkable)

Subordinate Guardsman

F	A	S	E	R	I	P
Ex	Ex	Rm	Rm	Ty	Ty	Ty

KNOWN POWERS

- Pistol* - This version of the armor has no repulsors. Instead, these men carry conventional plasma beam pistols.
- Other Powers* - The suit has the remaining

powers of O'Brian's suit at -1 CS. The cutback was made so that the armor could be more easily mass-produced and to minimize the damage caused if guards got trigger-happy. Functionally, these suits are similar in power to S.H.I.E.L.D.'s Mandroids.

Limitation - Sonic Immobilizer. A high-frequency sonic signal, known only to Iron Man, will immobilize the Guardsman armor for 10 rounds.

The Vault uses airtight cells, sedative gas, energy-draining fields, and force-fields as restraint measures, and can effectively imprison beings with powers of Unearthly rank or less. For an extreme case, the Vault has a cell built of secondary adamantium (Shift X material strength due to the thickness of the walls). Surveillance and security systems within the Vault are of Remarkable rank.

AVENGERS

ANT-MAN I/GIANT-MAN I/ GOLIATH I/YELLOWJACKET I/HENRY PYM

F	Gd	(10)					Health: 50
A	Gd	(10)					
S	Gd	(10)					Karma: 36
E	Ex	(20)					
R	Ex	(20)				Resources: Gd	
I	Gd	(10)					
P	Ty	(6)					Popularity: 30

The ranks listed above apply to Henry Pym since his retirement. He had different ability ranks at various points in his adventuring career.

Ant-Man I

F	A	S	E	R	I	P
Ty	Ty	Ty	Ty	Ex	Gd	Ty

Health: 24 Karma: 36

Powers: Shrinking, Insect Communication and Control, Flying Ant, Loudspeaker, Resistance to toxins.

Giant-Man I

F	A	S	E	R	I	P
Gd	Ty	Gd	Gd	Ex	Gd	Ty

Health: 36 Karma: 36

Powers: Shrinking, Insect Communication and Control, Growth.

Goliath I

F	A	S	E	R	I	P
Gd	Gd	Gd	Ex	Ex	Gd	Ty

Health: 50 Karma: 36

Powers: Shrinking, Growth, Protected Vision.

Yellowjacket I

F	A	S	E	R	I	P
Ex	Ex	Gd	Ex	Ex	Gd	Ty

Health: 70 Karma: 36

Powers: Shrinking, Insect Communication and Control, Protected Vision, Flight, Disruptor Pistol, Disrupter Sting.

KNOWN POWERS:

Henry Pym has not used superhuman Powers since his retirement and may no longer have any superpowers. The powers described below are keyed to the heroic identities used by Pym.

Shrinking (all identities): Pym had shrinking powers of Incredible rank. As Ant-Man, he used a special gas that gave him this power; this gas could also be used to shrink other people and objects. Long-term exposure to the gas allowed him to shrink at will in his later identities. Pym retained his normal Strength (for combat purposes) when reduced in size.

Insect Communication and Control (Ant-Man, Giant-Man, Yellowjacket): Cybernetic circuitry in his helmet gave Pym this power. As Ant-Man his power rank was Remarkable; as Giant-Man his Power rank was Good, as Yellowjacket his power rank was Remarkable. Established power stunts included using insect swarms to attack foes, and using insects to spell out messages on floors.

Flying Ant (Ant-Man): Ant-Man often rode a flying ant that flew at Poor speed.

Loudspeaker (Ant-Man, Yellowjacket): This item is built into Pym's helmet and allowed him to talk at normal volume when he was reduced in size.

Resistance to Toxins (Ant-Man): Pym's helmet has a retractable plexiglas facemask. When sealed, the helmet provides Excellent protection against gases.

Growth (Giant-Man, Goliath): Further development of the shrinking gas gave Pym Growth powers. Giant-Man originally had a power rank of Typical, which later increased to Shift Z. He could easily support his body at any size, but was limited to Amazing Strength at maximum height. As Goliath, his power rank was Monstrous, but his Strength limit at maximum height was Incredible. Using this power placed great strain on Pym's body. On several occasions he was "frozen" at a particular height, or did not have full control of his power.

Protected Vision (Goliath, Yellowjacket): Pym wore goggles that gave him Excellent protection.

Flight (Yellowjacket): Pym could fly at Good speed, using the powered wings on his costume. He could fly at normal or reduced size.



Disruptor Pistol (Yellowjacket): The pistol has a range of 1 area and inflicts Excellent energy damage.

Disruptor Sting (Yellowjacket): These are built into his gauntlets. They have a range of 1 area and inflict Remarkable energy damage. The stings replaced the disrupter pistol.

TALENTS: Henry Pym is a brilliant scientist, skilled in a variety of fields. He has Chemistry, Biology, Genetics, Electronics, Physics, and Engineering skill. His greatest scientific accomplishments were the discovery of the subatomic "Pym panicle" which allowed changes in size, and the creation of a robot with creative, independent intelligence-Ultron.

CONTACTS: Henry Pym is a trusted and valued friend of the Avengers, and he is now on good terms with his ex-wife, Janet Van Dyne. Another friend is Scott Lang, who uses Pym's costume and equipment as Ant-Man II.

BACKGROUND: When Pym and his new bride Maria were on a vacation in her native Hungary, Maria was murdered by the secret police. Pym was shattered by his wife's death and suffered a brief mental breakdown. Upon his return to America he vowed to use his talents to fight injustice.

The discovery of the "Pym particle" gave him the means to wage that fight. The first time he used his shrinking formula on himself he was seized by ants and barely escaped. After this, he created the identity of Ant-Man. One of his earliest enemies was the criminal scientist Egghead, who would bedevil Pym until his death.

After Janet Van Dyne's father was murdered by an alien, Pym, impressed by her courage, offered to make her his partner. She agreed and Pym created the identity of the Wasp for her. Ant-Man and the Wasp were two of the founding Avengers.

Feeling overshadowed by the more powerful Avengers, Pym developed an enlarging gas and assumed the identity of Giant-Man. However, Pym was not satisfied with his performance as a hero, and being a giant was endangering his health. Giant-Man and the Wasp retired for a time, and when they returned to the Avengers, Pym tried for a fresh start in the new identity of Goliath.

As Goliath, Pym faced Ultron for the first time. He later learned that the insane, murderous robot was his own creation, and was tormented by guilt.

Pym had continued doing scientific research in his spare time, but without any major new discoveries. One day a lab accident caused Pym to have another temporary mental breakdown and he assumed the identity of Yellowjacket. As Yellowjacket, Pym

married the Wasp, who recognized Pym in his new identity.

Pym's emotional instability continued, and he suffered a third breakdown when Ultron brainwashed him and created the robot Jocasta with Pym's help.

The continued frustration of his unsuccessful research and a court-martial for misconduct as an Avenger triggered his fourth and most serious breakdown. Pym built a robot to attack the Avengers, thinking that he would be acquitted if he defeated it. The plot was exposed, Pym was expelled from the Avengers, and the Wasp divorced him.

At this, the lowest point in Pym's life, Egghead, who had organized the third Masters of Evil, blackmailed Pym into joining his criminal scheme. Pym pretended to cooperate, but turned the tables, secretly building a weapon that would enable him to fight Egghead. The Avengers came to Pym's rescue, to discover that Pym had beaten the Masters by himself. Egghead tried to shoot Pym, and was killed accidentally by Hawkeye.

Further tragedy occurred in Pym's life when the robot Ultron-12, which had evolved a personality that loved Pym and respected him as a "father," was fatally damaged when it and Wonder Man saved Pym from death at the hands of the still-insane Ultron-11.

Pym later joined the West Coast Avengers as a resident scientist, but has permanently retired as an adventurer. Ironically, all of Pym's former identities have been used by others at various times. Three of these are still active, the criminals Goliath and Yellowjacket, and the hero Ant-Man.

BEAST

Henry McCoy

F	In	(40)	Health: 130
A	In	(40)	
S	Rm	(30)	Karma: 50
E	Ex	(20)	
R	Ex	(20)	Resources: Ex
I	Gd	(10)	
P	Ex	(20)	Popularity: 25

KNOWN POWERS:

Modified Body Parts: Beast's feet are well-developed and may be used as hands to handle objects or to attack.

Climbing: Because of his simian stance and capabilities, Beast can climb with Remarkable ability.

Lightning Speed: The Beast can move at up to 6 areas per round, accelerating to that speed in a single round.

TALENTS: The Beast is an expert in Biochemistry, Genetics, and Electronics. He uses Acrobatics, Tumbling, and Martial Arts C in combat. The Beast is fluent in a dozen languages. As an Avenger, the Beast's scientific talents were rather under-used since several Avengers were even more skilled in these areas.

CONTACTS: As an Avenger, the Beast maintained his contacts with the X-Men. It is presumed that the Beast was the source for the information the Avengers have on the X-Men.

BACKGROUND: Hank McCoy joined the Avengers at a time when they were short-handed following the marriage of the Scarlet Witch and Vision and the departure of Mantis and the Swordsman. His career as an Avenger was long and successful, during which he had an especially close friendship with Wonder Man. Never noted for solemnity or respect for authority, the Beast resented Henry Gyrich's restrictions even more than the other Avengers did. During his career with the Avengers, the Beast was in his blue-furred form, rather than the normal form he now has.

BLACK KNIGHT (Update)

Dane Whitman

F	Rm	(30)	Health:	70
A	Ex	(20)		
S	Gd	(10)	Karma:	22
E	Gd	(10)		
R	Gd	(10)	Resources:	Ex
I	Ty	(6)		
P	Ty	(6)	Popularity:	40

KNOWN POWERS:

Unique Weapon-Ebony Sword: Recently, the Black Knight has discovered powers in the sword of which he was previously unaware. The sword can slice through fields of non-magical energy (such as Kang's force-field) as well as magical ones. The sword can also deflect non-magical energy. If held in a particular way, it can also absorb energy blasts; the Knight can then "fling" the energy back at the enemy as an attack of equal rank. All these should be considered established power stunts except the energy absorption/returned attack power stunt, which must be developed normally.

Mystical Boobytrap: If an enemy picks up the Ebony Sword, or makes a successful Grab attempt, the sword inflicts Incredible Energy damage each round that the foul villain is in contact with the blade. The origin of this effect is unknown, but, probably similar to "worthiness" enchantments seen in other items, (like Thor's hammer).

Flying Horses: Earlier in his career, Black Knight used two mutated winged horses, Aragorn and Valinor; Aragorn was later used by the Valkyrie, while Valinor has lost his wings. Both had the following similar abilities.

F	A	S	E	R	I	P
Gd	Ex	Rm	In	Ty	Gd	Ty

Brazier of Truth: By kindling a flame in this mystic artifact, Whitman could speak with the spirit of his ancestor, Sir Percy of Scandia, and ask for advice. Sir Percy has Incredible resources in knowledge. The Black Knight had to destroy the brazier to purge himself of a blood-curse he inherited with the blade, caused by the killings Sir Percy had done with the sword.

TALENTS: In addition to his other talents, Whitman has Physics and Repair/Tinkering skills.

BLACK PANTHER

T'Challa, King of Wakanda

F	Am	(50)	Health:	140
A	In	(40)		
S	Ex	(20)	Karma:	60
E	Rm	(30)		
R	Gd	(10)	Resources:	Am
I	Rm	(30)		
P	Ex	(20)	Popularity:	55

KNOWN POWERS:

Infravision: The Black Panther has Excellent infravision and can see well even on moonless nights. However, he cannot see in absolute darkness.

Tracking: The Black Panther's keenly-honed senses give him Amazing Tracking ability. Outdoors, he can follow a trail up to 12 hours after it was made; in a city environment, the time limit is 6 hours.

TALENTS: In combat the Black Panther uses Martial Arts A, B, C, and E, as well as Acrobatics and Tumbling skills. He is also trained in Physics.

CONTACTS: In addition to the Avengers connection, the Black Panther is a good friend of the Fantastic Four. As King of Wakanda, the Black Panther has diplomatic immunity in the United States.

BACKGROUND: T'Challa became king of his native land when his father was killed by the villain Klaw. Before assuming the kingship, T'Challa had a lengthy education in the United States. After passing a ritual test, he gained the powers of the Black Panther, the defender of Wakanda. Wakandan culture combines tradition with high technology, and some of the Avengers equipment, such as the Quintet, Captain America's van, and Falcon's wings, are of Wakandan design.



BLACK WIDOW

Natasha Romanova

F	In	(40)	Health: 100
A	pin	(301)	
S	Gd	(10)	Karma: 70
E	Ex	(20)	
R	Go	(10)	Resources: Gd
I	In	(40)	
P	GO!	(20)	Popularity: 30

KNOWN POWERS:

Weapons - Widow's Bite: The Black Widow wears bracelets that include a number of weapons and devices.

- Electro-blaster (Excellent Energy attack, range 4 areas)
- Gas launcher (fires gas-filled capsules, usually Excellent intensity tear gas; range 4 areas gas fills 1 area)
- Cable launcher (length 3 areas, Incredible strength material, includes a grappling hook)
- Two way radio (can be tuned to a classified S.H.I.E.L.D. frequency)

Wall-Crawling: The gloves and boot-soles of the Widow's costume are covered with microscopic suction cups which enable her to wall-crawl with Remarkable ability.

Weapon - Explosive Belt: The belt is covered with explosive filled discs that function as grenades. Each disc explodes for Remarkable damage. This belt was once a standard part of the Black Widow's costume, but she seldom wears it now.

TALENTS: The Black Widow is a Weapon Specialist with her Widow's-Bite (+2 CS when using the weapons or cable) and also uses Martial Arts A, B, and E in combat. She also has Detective/Espionage and Military skills and speaks several languages.

CONTACTS: The Black Widow has worked with the Avengers, S.H.I.E.L.D., and the Champions of Los Angeles. In the past, she has had romantic relationships with Hawkeye and Daredevil, and is still a friend of both.

BACKGROUND: After her test-pilot husband was reported killed, Natasha became a spy for the Soviet KGB. Her first assignment in America was to infiltrate Stark Industries, but she was thwarted by Iron Man. Eventually, she defected and was granted legal amnesty. She has served with the Avengers on occasion.

FALCON

Sam Wilson

F	Rm	(30)	Health: 100
A	Rm	(30)	
S	Gd	(10)	Karma: 40
E	Rm	(30)	
R	Gd	(10)	Resources: Ty
I	Gd	(10)	
P	Ty	(20)	Popularity: 40

KNOWN POWERS:

Flight: The Falcon wears a jet-powered wing-harness that enables him to fly at Excellent speed. For short periods (10 rounds maximum), he can fly at Remarkable speed, but this requires a successful green Endurance FEAT roll because of the difficulty in breathing when flying at that speed. The Falcon can carry up to 200 pounds in flight, or 400 if he makes a successful Strength FEAT roll. The Falcon can shut down the wing-jets and glide at Good speed, this maneuver allows him to blindside unsuspecting opponents.

Animal Communication and Control, Birds: Falcon uses this power at Incredible rank when working with Redwing, and at Excellent rank with all other birds.

Pet. Redwing: Redwing is an extraordinary hunting falcon with a semi-empathic link to its master. Redwing's talons inflict Poor Edged Attack damage. Redwing flies at Excellent speed.

F	A	S	E	R	I	P
Gd	Ex	Pr	Rm	Fb	Rm	Ex

Health 64 Karma 52

TALENTS: Falcon uses Martial Arts A and E, as well as Acrobatics. He has developed Aerial Combat skill (+1 CS to Fighting and Agility in flight).

CONTACTS: The Falcon was a partner of Captain America for a time. The Black Panther provided Falcon with his wings.

BACKGROUND: Sam Wilson, a Harlem social worker, became a pawn of the Red Skull when his airplane crashed on the Skull's island base. Captain America rescued Wilson and trained him as an adventurer. Henry Gyrich drafted Wilson to fill a slot in the Avengers, but not being a "team player," the Falcon served only a brief time.

GOLIATH II

Clint Francis Barton

F	Gd	(10)	Health: 60
A	Ex	(20)	
S	Gd	(10)	Karma: 42
E	Ex	(20)	
R	Ty	(6)	Resources: Ex
I	Rm	(30)	
P	Ty	(6)	Popularity: 35

KNOWN POWERS:

Growth: Goliath derived his power from the growth serum developed by Henry Pym. His power rank was Unearthly, but his Strength limit at maximum height was Incredible. If he grew to maximum size in one round, he had 10 make a successful Endurance FEAT roll to avoid losing consciousness for 1-10 rounds. He could safely increase his size 5 ranks in a single round.

TALENTS: Barton had the same talents in his Goliath identity that he has as Hawkeye. He is a Weapon Specialist with bows and a Marksman. He also used Martial Arts A and E.

CONTACTS: Goliath was a member of the Avengers.

BACKGROUND: Barton assumed the identity of Goliath shortly after Henry Pym's debut as Yellowjacket. Barton gave up this identity at the end of the Kree-Skrull War and resumed his Hawkeye identity.

HELLCAT

Patsy Walker, later Hellstrom

F	Gd	(10)	Health:	46
A	Ex	(20)		
S	Ty	(6)	Karma:	32
E	Gd	(10)		
R	Ty	(6)	Resources:	Ty
I	Ty	(6)		
P	Ex	(20)	Popularity:	20

KNOWN POWERS:

Claws: When with the Avengers, Hellcat wore gloves and boots fitted with steel claws that allowed her to inflict Good Edged damage, or to cut through objects of Good strength material. After leaving the Avengers, she replaced them with normal gloves and boots.

Cable Claw: This is a cable-launching device that straps to Hellcat's wrist. The cable has a length of 2 areas and is made of Excellent strength material

Telekinesis: Moondragon's training enabled Hellcat to develop this power at Poor rank. Hellcat was able to manipulate and move a maximum of 100 pounds. Moondragon later used her own mental powers to remove this ability.

Magic Detection: Hellcat has this power at Excellent rank.

TALENTS: Patsy Walker has Performer, Occult Lore, Martial Arts B, D, and E, and Resist Domination talents.

CONTACTS: Patsy Walker has contacts with the Avengers and with members of the Defenders (a defunct hero group). She is married to Daemon Hellstrom, a retired Defender.

BACKGROUND: Fashion model Patsy Walker's desire to be a hero became a possibility when she learned the secret identity of the Beast (who had not yet mutated into a furry form). On a mission with the Beast, Walker discovered one of Greer Nelson's old Cat costumes. She put on the costume and assumed the identity of the Hellcat. Later, Moondragon convinced Hellcat to go to Titan for training in martial arts and mental techniques. Upon returning to Earth, she joined the Defenders for a long time, then left to investigate occult events at her husband's side.

THE HULK

Robert Bruce Banner

F	Rm	(30)	Health:	190
A	Gd	(10)		
5	Mn	(75)	Karma:	32
E	Mn	(75)		
R	Ty	(6)	Resources:	Fb
I	Ty	(6)		
P	Ex	(20)	Popularity:	0

The ranks listed above apply to the Hulk only during the time he was an Avenger.

KNOWN POWERS:

Body Armor: The Hulk's gamma-irradiated skin provides him with Amazing protection against physical attacks and Incredible protection against energy attacks.

Resistance: The Hulk has Monstrous resistance to cold, heat, fire, and disease.

Leaping: The Hulk's powerful legs give him Class 1000 Leaping ability (8 areas per round).

Adrenaline Surge: In combat, the Hulk's rage can increase his Strength and Fighting ability. After three rounds of Combat with an enemy, apply a +1CS to Strength and Fighting if the Hulk makes a successful Psyche FEAT roll. Multiple shifts are possible, but the upper limit on Fighting and Strength is Shift X. If an opponent is defeated, the Hulk's abilities return to normal in one round.

Alter Ego: The Hulk's alter ego is physicist Bruce Banner

F	A	S	E	R	I	P
Pr	Ty	Ty	Ty	Rm	Gd	Ty

TALENTS: The Hulk has none. Banner is trained in physics and radiation.

CONTACTS: The Hulk's only contact is Rick Jones. Banner has contacts in the U.S. Defense Department.

BACKGROUND: The Hulk was one of the five original Avengers. At the time, he was both less powerful and less savage than he is today. However, despite his greater intelligence, the Hulk was still too brutish and bad-tempered to remain with the Avengers. He quit the team after their second adventure and has fought them several times since.





IRON MAN

Anthony Stark

F	Ex	(20)		Health: 166
A	Ex	(20)		
S	In	(40)		Karma: 66
E	Mn	(75)		
R	In	(40)		Resources: In
I	Ex	(20)		
P	Ty	(6)		Popularity: 70

Two men have worn the Iron Man armor: Tony Stark, its inventor, and James R. "Rhodey" Rhodes, Stark's pilot and longtime friend.

Tony Stark

F	A	S	E	R	I	P
Ty	Ty	Pr	Ty	In	Ex	Ty

James R. Rhodes

F	A	S	E	R	I	P
Gd	Gd	Ty	Ty	Gd	Ex	Ty

KNOWN POWERS: Mark V Armor; for Mark VI, see MARVEL SUPER HEROES Advanced Set; for earlier suits, see the following.

Body Armor: The Mark V Armor is made of Remarkable strength material, reinforced by a magnetic field. The suit provides Amazing protection from physical attacks, Amazing protection from energy and force attacks, Remarkable protection from heat, cold, and corrosives, and Unearthly protection against radiation and electrical attack.

Flight: Jet engines in the boots allow flight at Shift X speed (50 areas/round). The jets can be used as weapons, causing Remarkable Energy damage at a range of 1 area.

Repulsors: These are Iron Man's main weapons, located in each gauntlet. At full power they inflict Amazing Force damage and can be set to inflict less. They have a range of 10 areas.

Unibeam: Mounted in the center of the chestplate, the beam has a range of 3 areas and can produce the following effects: searchlight of ultraviolet, visible light, or Infra-red, Remarkable Intensity; laser (Energy attack) of Incredible intensity.

Energy Absorption: Maximum capacity is 300 points which can be safely stored for 3 rounds. Longer storage requires a successful Endurance FEAT roll to avoid Good damage to all within one area, including Iron Man, whose body armor is ignored for this

effect. Absorbed energy can be channeled through the armor's weapons for Monstrous damage.

Override: Disconnecting the safety devices allows Strength or repulsor damage to be raised to Unearthly, or +1CS to any other ability or equipment. After each round, make an Endurance FEAT roll on the Shift 0 column, failure means the armor is immobilized.

Air Supply: When sealed, the armor has a 2-hour air supply, and provides Unearthly resistance to toxic gases.

Protected Senses: This feature provides Amazing protection against high-intensity light or sonic attacks. Iron Man suffers 1 round of deafness or blindness while his senses adjust.

Briefcase: The pieces of the armor are flexible enough to be carried in a special briefcase designed for this purpose. The locks on the briefcase are keyed to Tony Stark's and James Rhodes' fingerprints. Forcing the case open activates a self-destruct mechanism that destroys the armor's circuitry.

LIMITATION: After years of wearing this armor, Stark was incapacitated by alcoholism and he gave the suit to Rhodes. When Stark recovered, he let Rhodes keep this armor.

TALENTS: Stark has Electronics, Engineering, and Business skills. Rhodes is a pilot and can fly fixed wing, helicopter, and orbital craft. Rhodes also has Military skill.

CONTACTS: Both men were Avengers. Stark lost control of Stark International during the time he wore the Mark V armor. Stark has contacts with Nick Fury and S.H.I.E.L.D., but these sometimes degenerate from Friendly to Neutral. Stark is a member of the jet set.

Mark II Armor

The Mark II model was Iron Man's first battle-worthy armor, capable of defeating super-powered opponents. With this armor, Iron Man became a founding Avenger. The armor raised Stark's abilities to the following levels:

F	A	S	E	R	I	P
Gd	Gd	Rm	In	In	Ex	Ty

Health: 90 Karma: 66

KNOWN POWERS:

Body Armor: The Mark II armor is made of

Remarkable material. The suit provides Remarkable protection from physical attacks, Good protection from energy, force, heat, cold, corrosives, and electrical attack.

Flight: Boot-jets allow flight at Monstrous speed.

Electromagnetic Beams: Forerunners of the repulsors, these were located in each gauntlet. They provided Incredible magnetic control powers, and had a range of 5 areas. Deflecting steel projectiles (such as artillery shells or automobile debris) in flight is an established power stunt for Iron Man.

Electrical Absorption: Maximum capacity is 100 points, which can be safely stored for 2 rounds. Longer storage requires a successful Endurance FEAT roll to avoid Good damage to all within one area, including Iron Man, whose body armor is ignored for this effect.

Pacemaker: This was required to keep Stark's injured heart beating. If the armor's chestplate is destroyed, Stark must make an immediate Endurance FEAT roll, and another Endurance FEAT roll every 10 rounds thereafter. Failure means that he loses 1 Endurance rank, but remains conscious. If Stark slips below Shift 0, he dies. Stark's Endurance can be stabilized in the usual manner.

LIMITATION: Tony Stark's heart was injured by shrapnel. He uses a pacemaker in his chestplate.

Mark III and Mark IV Armors

These were interim suits of similar abilities that led to the final development of the Mark V. The Mark III was the first suit of red-and-gold armor. These armors raised Stark's abilities to the following levels:

F	A	S	E	R	I	P
Ex	Ex	In	Am	In	Ex	Ty

Health: 130 Karma: 66

KNOWN POWERS:

Body Armor: These armors were made of Incredible strength material. The suit provides Incredible protection from physical attacks, Excellent protection from energy, force, heat, cold, corrosives, and electrical attacks.

Flight: Boot-jets allow flight at Unearthly speed.

Electromagnetic Beams: Identical to the Mark II armor; later replaced by repulsors.

Repulsors: These repulsors inflict Incredible Force damage and have a range of 7 areas.

Electrical Absorption: Maximum capacity is 200 points, which can be safely stored for 2 rounds; otherwise the same as the Mark V armor.

Chest-lamp: A searchlight of Remarkable intensity with a range of 3 areas.

Air Supply: One hour; otherwise the same as the Mark V.

Protected Senses: Excellent protection; otherwise the same as the Mk V.

Pacemaker: The same as the Mark II armor.

LIMITATION: Injured heart, later curl through a successful heart transplant.

BACKGROUND: Rhodes owns the Mark V armor, but avoids wearing it now that Stark is using the Mark VI. The earlier armors were kept in storage at Stark International. When Obadiah Stane took control of Stark International, Rhodes destroyed all suits except his own.

JOCASTA

Robot (Avengers applicant)

F	Gd	(10)	Heath: 170
A	Ex	(20)	
S	In	(10)	Karma: 24
E	Un	(100)	
R	Gd	(10)	Resources: Fb
I	Pr	(4)	
P	Gd	(10)	Popularity: 20

KNOWN POWERS:

Optic Beams: Jocasta's eyes could emit heat beams of Incredible intensity (Energy attack) to a maximum range of 5 areas.

Body Armor: Jocasta had Amazing body armor because of the advanced steel alloys used in her construction.

Resistances: Jocasta was invulnerable to toxins and disease, and had Incredible Resistance to fire/heat, cold, and radiation.

Enhanced Senses: Jocasta had Remarkable vision and hearing.

Detection: Jocasta had Energy Detection and Mutant Detection abilities of Amazing rank.

TALENTS: None.

CONTACTS: None other than the Avengers.

BACKGROUND: Ultron created Jocasta's robotic body, then brainwashed Henry Pym into granting Jocasta full intelligence and transferring the life-force of his wife into the robot. Had the transfer been completed, Janet Pym would have died. Jocasta saved Janet Pym by summoning the Avengers. The transfer, although not complete, gave Jocasta a compassionate, human-like personality and the ability to feel emotions. She later became a guest of the Avengers and shared several adventures with them, but never became a full member. In fact, she often felt neglected by the Avengers. She was destroyed by a nuclear explosion while helping Machine Man fight Ultron.

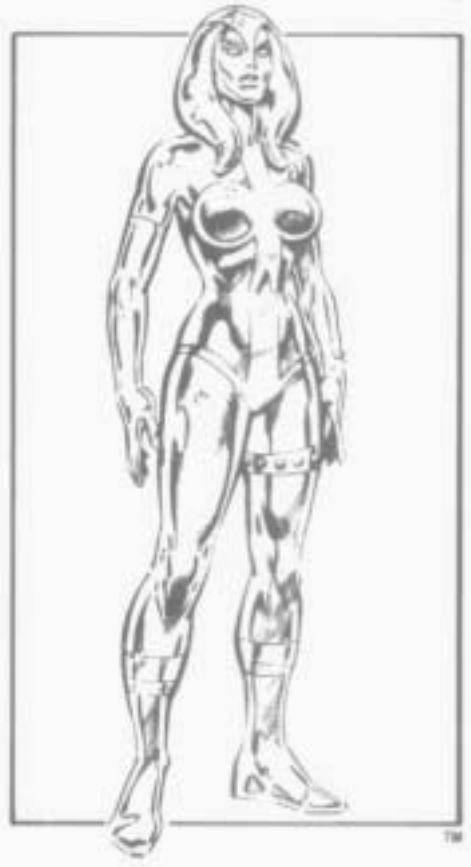

MANTIS

Real Name Unrevealed

F	In	(40)	Health: 116
A	In	(40)	
S	Ty	(6)	Karma: 76
E	Rm	(30)	
R	Ty	(6)	Resources: Fb
I	Ex	(20)	
P	Am	(50)	Popularity: 20

KNOWN POWERS:

Empathy: Mantis has this power at Amazing rank because of the training of the Priests of Pama.

Recovery: Mantis has "complete control" of her body, giving her Recovery powers of Amazing rank.

Resistances: Mantis has Incredible Resistance to toxins and diseases.

TALENTS: Mantis uses Martial Arts A, B, D, and E in combat, and the Resist Domination talent.

CONTACTS: Mantis gained her powers and talents through the Priests of Pama, who have since been slaughtered. Her father is Gustav Brandt, the criminal Libra. Mantis was an ally of the Swordsman and the Avengers, and briefly an Avengers member. She now wanders the universe in the company of the Swordsman, whose body is animated by the life-force of a member of the Cotati, a tree-like alien race.

BACKGROUND: While fleeing from Vietnamese criminals, Brandt and his young daughter found the temple of the Priests of Pama, a group of pacifistic Kree exiles, who lived among the Cotati. The priests separated Brandt and the child and raised her, training her in the powers and talents she now has. When she was grown, they implanted a set of false memories within her and sent her to live among humans. She met the Swordsman, who was then an alcoholic fugitive, and convinced him to reform. The Swordsman took her to America, and when he rejoined the Avengers, she became their ally. Her future destiny as the Celestial Madonna, the mother of a being who would bring peace to the universe, was discovered by Kang. The Swordsman died while protecting Mantis from Kang, but his body was later re-animated by a Cotati who revealed that he was Mantis' destined mate. The two then left Earth to journey among the stars

MOONDRAGON

Heather Douglas

F	Rm	(30)	Health: 100
A	Rm	(30)	
S	Gd	(10)	Karma: 60
E	Rm	(30)	
R	Gd	(10)	Resources: Fb
I	Ex	(20)	
P	Am	(50)	Popularity: 0

KNOWN POWERS:

Telepathy: Moondragon has Uearthly rank telepathic powers, and can easily maintain contact with several minds at once. Her psi-screens are of Amazing rank.

Mind Control: Moondragon has Uearthly powers of mind control. Once control is established, she can easily maintain it over several victims simultaneously.

Psionic Attack: This power is of Incredible Intensity but its range is limited to 2 areas.

Telekinesis: She uses this power at Remarkable rank. Moondragon cannot fly using this power, but has developed telekinetic force bolts as an established power stunt (Excellent Intensity, range 6 areas).

Recovery: Moondragon's mental training has given her Recovery Powers of Amazing rank.

TALENTS: Moondragon has demonstrated skill in Genetics and Biochemistry. She also uses Martial Arts B and D.

CONTACTS: Moondragon was a member of the Avengers and the Defenders, but antagonized both groups. She also has contacts with Titan.

BACKGROUND: Moondragon's greatest services were in the Avengers battles against Thanos, but her own arrogance made it impossible for her to remain with the Avengers. She later used her mental powers to force peace on a war-torn world, which she ruled as a self-proclaimed "goddess." The planet was liberated by the Avengers, and Odin placed restraints on her power until she proved her worthiness to the Defenders, a group that included one of Odin's Valkyries. Moondragon later turned against the Defenders and apparently died lighting some of them.

MS. MARVEL

Carol Susan Danvers

F	Gd	(10)	Health: 120
A	Ex	(20)	
S	Am	(50)	Karma: 60
E	In	(40)	
R	Gd	(10)	Resources: Ex
I	Ex	(20)	
P	Rm	(30)	Popularity: 40

KNOWN POWERS:

Body Armor: Ms. Marvel's tough flesh provided Incredible protection against physical attacks and Excellent protection against energy attacks.

Flight: Ms. Marvel could fly at Excellent speed (10 areas per round).

Combat Sense: This power was of Incredible rank, used in place of Intuition in combat situations. Ms. Marvel called this her "seventh sense."

TALENTS: Ms. Marvel had Military, Detective/Espionage, and Journalism talents. She also used Martial Arts B and E.

CONTACTS: Besides her membership in the Avengers, Ms. Marvel had contacts with S.H.I.E.L.D. and NASA.

BACKGROUND: Carol Danvers gained her powers after she became embroiled in a battle between Captain Mar-Vell and Colonel Yon-Rogg that resulted in her being irradiated by a Kree "psyche-magnitron," a device that augmented her genetic structure. Ms. Marvel assisted the Avengers in the battle against Korvac, then became an official member for a short time.

Marcus, the son of Immortus, attempted to escape Limbo by secretly implanting his life-essence in Ms. Marvel. Through her, Marcus was born on Earth, and he manipulated her into returning to Limbo with him. After her escape from Limbo, her memories and powers were permanently drained by the mutant Rogue. Danvers' memories were restored by Professor X. Later, a malevolent alien race, the Brood, used an evolutionary ray to transform her into Binary, a being wielding cosmic energy. When with the Avengers, Danvers was a self-confident, aggressive combatant, but often seemed cool and unemotional. She bore some resentment because the Avengers did not question Marcus' motives when he manipulated her.

QUICKSILVER

Pietro Maximoff

F	Gd	(10)	Health: 150
A	Un	(100)	
S	Gd	(10)	Karma: 38
E	Rm	(30)	
R	Ex	(20)	Resources: Gd
I	Ty	(6)	
P	Go	(10)	Popularity: 20

KNOWN POWERS:

Lightning Speed: Quicksilver's normal maximum running speed is Shift X rank (12 areas per round/180 MPH). In addition to the normal abilities of this power, Quicksilver has some established power stunts.

- By running in a circle, creating a cyclone of Monstrous Intensity that can Stun or slam anyone caught in its winds.
- Catch arrows in mid-flight.
- Increase speed to Class 1000 for short periods (Endurance FEAT roll every 2 rounds to avoid exhaustion).

Body Armor: Pietro's extra-thick skin gives him Good body armor.

Protected Vision: Pietro's eyes are adapted to high speed running. They have Good protection.

Resistance to Cold: Thick skin and a hyper-efficient metabolism give Pietro Incredible resistance.

TALENTS: Pietro has Military talent, learned as an officer in the Inhuman Militia.

CONTACTS: Quicksilver has abandoned all contacts

BACKGROUND: Pietro is the son of the mutant Magneto, who enlisted him in the Brotherhood of Evil Mutants, but neither knew at the time that they were father and son. After leaving the Brotherhood, Pietro became an Avenger. He was wounded in battle and nursed back to health by Crystal the Inhuman, with whom he fell in love and married. Their personalities were not really compatible, and Crystal, feeling neglected, began a love affair with Norm Webster, neighbor of Pietro's sister, the Scarlet Witch. When Pietro discovered his wife's infidelity, he became enraged, bitter, and irrational. He left the moon and came to Earth, where he is currently at large.

SCARLET WITCH

Wanda (no surname used)

F	Gd	(10)	Health: 46
A	Gd	(10)	
S	Ty	(6)	Karma: 60
E	Ex	(20)	
R	Gd	(10)	Resources: Ty
I	Ex	(20)	
P	Rm	(30)	Popularity: 30

KNOWN POWERS:

Hex Spheres: This Power is a unique and formidable type of Matter and Energy Control, that causes unlikely events to occur to the target. Wanda cannot cause the impossible to happen (she cannot create objects from nothing or nullify gravity, for example) but her power is otherwise limited only by her imagination. For example, she can cause a device to suddenly malfunction, cause an object to collapse or fall apart, or deflect projectiles or energy bolts in flight.

In play the player running the Scarlet Witch should describe the desired event to the Judge such as "I want Kang's forcefield to overload and short out." The Judge assigns the intensity of the FEAT. The Judge can rule that the event requires a successful Power Stunt. Wanda's hex sphere is capable of affecting materials up to Class 1000 material strength, such as adamantium. In many adventures, Wanda's hex has delivered the *coup de grace* to the Avengers' foe (such as when she caused a mountain peak to collapse and entomb the demon Chthon, or when she cracked Ultron's body armor on two occasions).

Since she began formal training with Agatha Harkness, Wanda's control over her hex spheres has steadily improved. At present, she uses this power at Amazing rank.

Magical Abilities: Wanda's hex spheres have seemed magical in effect, and some have assumed that she was a true sorceress. She also has the potential to wield powerful magic (the potential was implanted by the demon Chthon when Wanda was born), but she only recently sought training in magic from a true sorceress, Agatha Harkness. Wanda has an intuitive "sense" of mystical events, has had dreams foretelling great danger, has detected the mystical "impression" left on a ritual object by it's previous user, has taught minor weather control magic to her teenaged student, and has at least twice used a magical ceremony to communicate with spirits in other dimensions. Treat the use of all of these as Power Stunts. Compare the assigned Intensity of the stunt to Wanda's Psyche rank.

If you are using *MHAC 9, Realms of Magic*



as part of your campaign, most of these Power Slums are formally defined as magical powers. In the order listed, they are Sensing, Mystical Detection (P), Sensing, Danger (P), Gramayre (P), Nature Control, Weather (U), and Dimensional Aperture, limited to communication (D). Wanda has a Remarkable rank in all these powers.

TALENTS: Wanda has a Magical Background and a wide knowledge of Occult Lore.

CONTACTS: Wanda is an Avenger of long standing, and is a friend of the Inhumans and Doctor Strange. Wanda received training from the sorceress Agatha Harkness, now deceased. Wanda can sometimes communicate with Agatha's spirit through a mystic ceremony. Wanda's relationship with her father, Magneto, is slowly improving. She is currently tutoring Holly Ladonna, a Leonia teenager, in minor magic. Wanda's best friends in Leonia are Glynis and Ilya Zarkov, the stage magicians Glamor and Illusion. Wanda is unaware that the Zarkovs are also jewel thieves.

BACKGROUND: Wanda was born on Wundagore Mountain, citadel of the High Evolutionary and prison of Chthon. She and her brother Quicksilver were raised among Django Maximoff's gypsies, but had to flee when a mob attacked the gypsies. They were recruited by Magneto and became members of the First Brotherhood of Evil Mutants. They eventually fled from his tyranny and joined the Avengers, where Wanda met and fell in love with her husband, the Vision. Wanda and the Vision have taken several leaves of absence, most recently after the Vision's attempt to seize control of the world. Through the use of magic, Wanda and the Vision have realized their long-held dream of having children. Wanda, Vision, and their sons Thomas and William live in Leonia, New Jersey, and are trying to live fairly normal lives despite the inevitable turmoil that is a part of any superhero's life.

STARFOX

Eros of Term

F	Gd	(10)	Health: 120
A	Ex	(20)	
S	In	(40)	Karma: 56
E	Am	(50)	
R	Ex	(20)	Resources: Ex
I	Ty	(6)	
P	Rm	(30)	Popularity: 75

KNOWN POWERS:

Flight: By manipulating gravitons, Starfox can fly at Shift X speed.

Invulnerabilities: Like all Eternals, Starfox is invulnerable to heat, cold, electricity, radiation toxins, and disease. Starfox ages far more slowly than do humans.

Recovery and Regeneration: Starfox has both of these powers at the Amazing rank.

Body Armor: Starfox has Good body armor.

Emotion Control, Pleasure: Starfox's "feelgood" Power is a specialized form of Emotion Control. This power is of Amazing rank, with a duration of 10-100 rounds, but the target can avoid control if he makes a successful Intuition FEAT roll. Affected targets will be friendly, non-hostile, and cooperative, obeying simple suggestions. However, if obeying any order from Starfox would cause a villain to lose Karma, he gets an immediate Psyche FEAT roll to attempt breaking control; failure means that he obeys. This power does not affect non-living opponents or berserk opponents.

TALENTS: None, but Starfox is familiar with the high technology of his homeworld, Titan.

CONTACTS: Starfox is the son of Mentor, ruler of Titan. He is currently a "partner" of Firelord, a former herald of Galactus.

BACKGROUND: Starfox joined the Avengers out of a love for adventure. After a successful career, he left to pursue the pirate Nebula.

SWORDSMAN

Real Name Unrevealed

F	Rm	(30)	Health: 80
A	Ex	(20)	
S	Gd	(10)	Karma: 18
E	Ex	(20)	
R	Ty	(6)	Resources: Ex
I	Try	(6)	
P	Ty	(6)	Popularity: 30

KNOWN POWERS:

Weapon, Makluan Sword: The sword is made of Monstrous strength material. In the Swordsman's hands, it inflicts 10 points Edged Attack damage or 16 points Blunt damage (with the fiat of the blade). Various other weapons are installed in it, fired by a button on the hilt. All of these affects have a range of 2 areas:

- Force Beam (Remarkable)
- Disintegrator (Remarkable, has no effect on living targets, requires 20 minutes to recharge)
- Flame Blast (Remarkable Intensity)
- Electrical Bolt (Remarkable Energy)
- Stun-Gas (Remarkable Intensity)

TALENTS: The Swordsman is a Weapon Specialist with his sword (+2 CS to all attacks) and has Sharp Weapon skill (+1 CS with all other blade weapons). He also has Military talent.

CONTACTS: Before joining the Avengers, Swordsman worked for many super-villains, including the Mandarin, the Red Skull, the Grim Reaper, Egghead, and Batroc.

BACKGROUND: The Swordsman had a long and unsuccessful criminal career, which at one point included joining the Avengers as the Mandarin's double agent. While working as a common thug in Indochina, he met Mantis and fell in love with her. Taking her with him to America, Swordsman rejoined the Avengers. He suffered considerable anguish because she did not return his love, but he selflessly gave his life to save her from Kang the Conqueror.

THOR (Update)

Thor of Asgard

F	Rm	(30)	Health: 140
A	Ex	(20)	
S	Am	(50)	Karma: 60
E	In	(40)	
R	Ex	(20)	Resources: Pr
I	Gd	(10)	
P	Rm	(30)	Popularity: 30

KNOWN POWERS:

Unique Weapon, Mjolnir: Thor has developed a particularly deadly Power Stunt with his hammer which he seldom uses on mortal opponents. Thor calls this his "unfettered might" attack. This is a Thrown Weapon attack, with a "wind-up" that increases damage from Shift X to Shift Y, and surrounds the hammer with a blaze of energy (use the Throwing Edged column for this attack). The friction-generated heat of the wind-up inflicts Incredible damage on Thor himself if he is not wearing his gauntlets (see below). If Thor is wearing his belt of strength while performing this stunt damage is raised to Shift Z. Thor is reluctant to use this stunt; he loses half his Karma every time he does so. This Stunt is used only against rampaging foes of great Power (such as Mangog, Fafnir, and Surtur) who must be stopped at all costs.

Gauntlets: These are made of Class 1000 uru metal and covers Thor's arms to the shoulder. They are useful when performing the "unfettered might" power stunt, or when facing death-goddess or mutants with a power absorption touch.

Belt of Strength: The belt raises Thor's Strength by a +1 CS. Thor can wear the belt as long as he likes, but when he removes it, he suffers -2 CS to his Endurance. Lost Endurance can be recovered normally.

Magic Detection, Illusions: Recent experience with a long string of illusion-casting foes has honed Thor's ability to spot such tricks. He receives a +1 CS to Intuition when confronted with illusions.

VISION

F	Rm	(30)	Health: 140
A	Ex	(20)	
S	Am	(50)	Karma: 60
E	In	(40)	
R	Ex	(20)	Resources: Pr
I	Gd	(10)	
P	Rm	(30)	Popularity: 30

KNOWN POWERS:

Density Manipulation, Self: The Vision can control his density with Unearthly ability. His normal density rank is Good. At densities above Good, the Vision gains Body Armor equal to the density rank. At densities above Incredible, he suffers a -1 CS to his Fighting and Agility. At densities above Amazing, use the density rank instead of Strength in charging combat. At Unearthly density, the Vision cannot move. The Vision can shift density ranks from Shift 0 to Unearthly or any rank in between, almost instantly. The Vision has developed a number of established power stunts with this power:

- Phasing through solid objects at Shift 0 density. Unlike normal Phasing, this does not cause malfunctions in electronics.
- Flight at Shift 0 density; speed is Poor.
- Disrupting living targets or non-living materials by solidifying inside them. Damage inflicted is equal to Visions chosen density rank; the target's body armor is ignored. The Visions computer-precise mind allows him to use this stunt with little risk of killing living beings.

Life Support: The Vision has Incredible Life Support powers and can survive in space for up to 40 rounds. He does not need to eat or breathe.

Solar Beams: The Vision can fire laser-like beams of solar heat (Energy attack) from his eyes or from the jewel in his forehead. Damage and range are Remarkable (8 areas).

Solar Regeneration: The Vision has this Power at Amazing rank. Indoors, the Vision can still heal at accelerated rate if solar or laser energy is directed at the jewel in his forehead.

LIMITATION: When the Vision was originally built, there was a "control crystal" in his brain that prevented him from having a fully human personality and also made him vulnerable to technological mind control devices (-2 CS to Psyche). The Vision recently removed the crystal so this limitation is no longer in effect.

TALENTS: The Vision has Repair/Tinkering talent.



CONTACTS: The Vision is an Avenger of long standing. His best friends in Leonia are Glynis and Ilya Zarkov, the stage magicians (and jewel thieves) Glamor and Illusion.

BACKGROUND: Ultron-5 obtained the deactivated body of the android Human Torch, originally built in 1939 and forced the android's creator, Prof Phineas T. Horton to remove the android's flame powers and replace them with the ability to synthesize energy and the ability to manipulate its density. Ultron then erased the Human Torch's memories, and gave the android a new personality based on that of Simon Williams, Wonder Man. Originally programmed to destroy the Avengers, the Vision turned against Ultron-5 and helped to destroy the robot. Joining the Avengers, the Vision had along and illustrious career, finally assuming the leadership of the Avengers on Earth during the first Secret War. By this time the control crystal in the Vision's brain was malfunctioning, causing him to concoct a misguided plan to impose peace on the world by controlling military and civilian computer networks. The Avengers convinced him to abort the scheme. and the Vision removed the defective control crystal. He was ultimately forced to resign from the team.

Despite his originally "cold, unfeeling" demeanor, the Vision's love for the Scarlet Witch has always been strong. With the removal of the control crystal, the Vision was able to develop a completely human personality. Recently, the vision developed strong family ties. He now regards Wonder Man as a brother, and the strong emotional bond between Vision and Wanda enabled them to have children through mystical means.

EDWIN JARVIS

F	Gd	(10)	Health: 36
A	Gd	(10)	
S	Ty	(6)	Karma: 36
E	Gd	(10)	
R	Gd	(10)	Resources: Gd
I	Ex	(20)	
P	Ty	(6)	Popularity: 50

KNOWN POWERS:

He has no Powers, however, Jarvis' service with the Avengers has made him virtually panic-proof.

TALENTS: Jarvis learned Martial Arts B in the Royal Air Force and was taught Martial Arts E by Captain America. His skill as a butler is indicated by the fact that he performs all the housekeeping tasks at Avengers Mansion, which would otherwise require a full staff of ordinary servants. Jarvis can operate any non-classified equipment in the Avengers Mansion, and will perform monitor duty if an emergency forces all Avengers to leave the mansion.

BACKGROUND: Edwin Jarvis had been employed by the Stark family for years before the Avengers organized, and stayed on when Tony Stark donated the mansion to the Avengers. He is always ready to render whatever assistance is needed in any situation, whether that assistance is moral or physical. (Outstanding accounts of Jarvis in his prime can be found in AVENGERS #201 and THOR #356.)

RICK JONES

F	Ty	(6)	Health: 26
A	Ty	(6)	
S	Ty	(6)	Karma: 22
E	Ty	(6)	
R	Ty	(6)	Resources: Fb
I	Gd	(10)	
P	Ty	(6)	Popularity: 5

KNOWN POWERS:

Psionic Powers, Latent: During the Kree-Skrull War, the Kree Supreme Intelligence stimulated Jones' latent psionic power, enabling Jones (and Captain Mar-Vell, who had a psychic link with him) to paralyze an entire Skrull fleet as well as Ronan's followers. The Supreme Intelligence claimed that all Earth humans had the ability to evolve psionic powers.

TALENTS: Rick Jones was taught Martial Arts E by Captain America. He also has Performer talent as a singer and guitarist.

CONTACTS: Rick was the leader of the Teen Brigade, a group of ham radio enthusiasts. He is an honorary Avenger and a staunch friend of the Hulk and Bruce Banner.

BACKGROUND: On a foolish dare, Rick entered the test site for the Gamma Bomb. In saving Jones, Bruce Banner was exposed to the radiation that transformed him into the Hulk. Later, Jones' Teen Brigade broadcast the distress call that resulted in the formation of the Avengers. For a time Jones was a partner to Captain America, who seeks to inspire America's youth to follow his noble Ideals

The Kree Supreme Intelligence chose Jones to form a psychic link with Captain Mar-Vell; this link was part of a scheme that halted the Kree-Skrull War. The Supreme Intelligence's ultimate intention was to kill both Jones and Mar-Vell and absorb their psyches, which would have given the Supreme Intelligence vast psionic Power, but this plot failed. Later during Earth's struggle against the Dire Wraiths, Jones became an ally of ROM. Recently, Jones was shot by ex-General T. E. "Thunderbolt" Ross when Ross attempted to prevent the marriage of his daughter Berry to Bruce Banner; Jones has since recovered. Although there is nothing outwardly distinctive or impressive about Jones, he seems fated to be the companion of heroes and participant in great events.

AVENGERS' ALLIES

ANT-MAN

Scott Edward Lang

F	Ty	(6)	Health: 28
A	Gd	(10)	
S	Ty	(6)	Karma: 22
E	Ty	(6)	
R	Gd	(10)	Resources: Gd
I	Ty	(6)	
P	Ty	(6)	Popularity: 20

KNOWN POWERS:

Shrinking: Ant-Man has shrinking powers of Incredible rank through the use of Henry Pym's shrinking gas. Lang retains his normal Strength (for combat purposes) when reduced in size. This gas can also be used to shrink other people and objects.

Insect Communication and Control: Cybernetic circuitry in his helmet gives Ant-Man this power at Remarkable rank. Established power stunts included using insect swarms to attack foes and using insects to spell out messages on floors.

Flying Ant: Ant-Man often rides a flying ant that flies at Poor speed.

Loudspeaker: Built into the helmet, this allows Lang to talk at normal volume when he is reduced in size.

Resistance to Toxins: Lang's helmet has a retractable facemask that provides Excellent protection against gases.

TALENTS: Ant-Man has Electronics and Repair/Tinkering skill. He also has enough Business/Finance skill to run a small shop.

CONTACTS: Ant-Man has helped the Avengers on occasion (twice against Taskmaster). He was a former employee of Stark International.

BACKGROUND: Scott Lang stole Henry Pym's Ant-Man costume to rescue an illegally held surgeon who could cure his daughter's failing heart condition. Pym allowed Lang to keep the costume when Lang promised not to use it for crime.

CAPTAIN MARVEL

Mar-Vell of the Kill, (dead)

F	Rm	(30)	Health: 130
A	Rm	(30)	
S	In	(40)	Karma: 90
E	Rm	(30)	
R	Gd	(10)	Resources: Pr
I	Am	(50)	
P	Rm	(30)	Popularity: 55

KNOWN POWERS:

NEGA-BANDS: These Kree weapons, worn on each wrist, provided Mar-Vell with several powers:

- Remarkable Body Armor
- Flight: Remarkable speeds in the atmosphere; Class 1000 speeds in space.
- Unearthly Life Support in outer space; Mar-Vell could journey through outer space under his own power without harm.
- Psychic Transfer: Captain Marvel and Rick Jones had a psychic link through the bands. Only one of the two could exist on Earth at any given time but the two personae could communicate telepathically. The one who was not on Earth was in the Negative Zone. That transfer occurred automatically when the one on Earth slammed the two bands together the other would appear on Earth wearing the bands.

Cosmic Awareness: The cosmic being Eon granted Mar-Vell this power at Monstrous rank, making him "Protector of the Universe."

Solar Bolts: Special radiation treatments gave Mar-Vell this Power to fire Energy bolts of Remarkable power and range

TALENTS: Mar-Vell used Martial Arts A and E in combat, and had Pilot, Military, and Detective/Espionage skills.

CONTACTS: Mar-Vell's friends included Rick Jones, the Avengers, and Drax the Destroyer

BACKGROUND: Mar-Vell, a Kree war hero, was sent to Earth as a pawn of both Ronan the Accuser and the Supreme Intelligence (whose schemes were in conflict), the latter scheme required the psychic link with Jones. Mar-Vell helped to protect Earth from Kree interference. He aided the Avengers in the Kree-Skrull War and later against Thanos; Mar-Vell gained his solar and cosmic awareness powers after the Kree-Skrull War. Mar-Vell's death was from cancer.



DRAX THE DESTROYER

Arthur Douglas (dead)

F	Gd	(10)	Health: 120
A	Ex	(20)	
S	In	(40)	Karma: 56
E	Am	(50)	
R	Ex	(20)	Resources: Ex
I	Ty	(6)	
P	Rm	(30)	Popularity: 75

KNOWN POWERS:

Immortality: Drax could not be slain by physical means. In addition to Immortality, Drax had Uearthly Life Support, Regeneration, and Recovery powers, and was invulnerable to heat, cold, electricity, radiation, toxins, and disease. However, Does could be Slammed or Stunned by physical attacks. Drax could be killed only by mental attack.

Force Blasts: Drax could fire beams of Amazing power and range (Force attack) from his hands.

Flight: Drax could fly at Class 1000 speeds in space but was limited to Shift X speed while in a planets atmosphere.

Obsession: When in the presence of his target, Thanos, Drax's mind was consumed by hatred, rage, and a single thought - kill Thanos! In this situation, apply a +1 CS to Drax's FASE abilities and force blast, as follows:

F	A	S	E	Health
Ex	Rm	Am	Mn	175

Force Blast: Monstrous

TALENTS: Ross Domination.

BACKGROUND: While on a reconnaissance mission to Earth, Thanos killed Arthur Douglas. His daughter Heather survived and eventually became Moondragon. Douglas' life-force was rescued by the Eternal Chronos and installed in a new indestructible body. This creature, Drax, was filled with an unrelenting hatred of Thanos and then unleashed. Drax assisted the Avengers in their battles with Thanos and later attempted to free an alien planet from Moondragon's mental tyranny. In self-defense, Moondragon used her mental powers to kill him. In life, Drax was easily roused to a seething fury, and pursued his foes with single-minded determination, making him a dreaded opponent.

FIREBIRD

Bonita Juarez

F	Ty	(6)	Health: 42
A	Gd	(10)	
S	Ty	(6)	Karma: 22
E	Ex	(20)	
R	Ty	(6)	Resources: Ty
I	Gd	(10)	
P	Ty	(6)	Popularity: 10

KNOWN POWERS:

Fire and Force Generation: Firebird can generate bolts of Amazing intensity flame or Incredible force; these bolts have a range of 3 areas. She cannot use both types of bolts simultaneously.

Body Armor: When flying or using her flame powers, Firebird's body is surrounded by a sheath of flame. These flames automatically destroy weapons of Remarkable strength material or less. Other forms of attack are as normal. Any attacker who touches Firebird's flaming body suffers Remarkable damage. Firebird cannot use this armor when making a force attack.

Resistance to Fire and Heat: Firebird has this power at Uearthly rank.

Firebird Effect: As a power stunt, Firebird can fill 3 areas with a blast of Amazing intensity flame shaped like a large bird.

Flight: Firebird can fly at Excellent speed (10 areas per round).

Magic Detection: Firebird has Excellent magic detection powers.

Post-Cognition: Firebird has seen an unexpected vision of the death of a 19th Century woman. This woman may have been an ancestor or a previous incarnation of Firebird herself, but the vision's true meaning remains unknown.

TALENTS: Bonita is a social worker for the state of New Mexico.

CONTACTS: Firebird is a member of the Rangers and has assisted the West Coast Avengers on an extended case.

BACKGROUND: Firebird gained her powers when struck by a fireball that fell from the sky. She and the other member of the Rangers met to stop a rampage by the Hulk, but did not form a lasting team.

GHOST RIDER

Hamilton Slade

F	Ty	(6)	Health: 66
A	Ex	(20)	
S	Ex	(20)	Karma: 60
E	In	(40)	
R	Gd	(10)	Resources: Gd
I	Ex	(20)	
P	Rm	(30)	Popularity: 5

KNOWN POWERS:

Alter Ego: The Ghost Rider's alter ego is archaeologist Hamilton Slade.

F	A	S	E	R	I	P
Ty	Gd	Gd	Gd	Gd	Ex	Ty

Slade and the Ghost Rider have separate personalities and memories.

Phasing: The Ghost Rider has Uearthly phasing powers. "Air-walking" is an established power stunt. While phasing, he is immune to physical and energy attacks, but not to mental or magical attacks.

Invisibility: Ghost Rider has Incredible invisibility powers.

Mystic Revolvers: Ghost Rider carries two ghostly revolvers. These fire "phantom bullets" that can pass through solid objects and have Incredible intensity stun effects on living targets. The ammunition supply for these guns seems endless. The bullets are non-lethal (treat Kill results as Stun).

Mystic Lariat: The lariat has a length of one area and can pass through solid objects to ensnare people (Amazing grappling attack). The rope is of Amazing strength material.

Mystic Horse, Banshee: This horse has the same phasing Powers as Ghost Rider, and can gallop on the ground or through the air at 3 areas per round.

Detection, Evil: Slade is transformed into the Ghost Rider when in the vicinity of "evil emanations." The maximum range of this power is about 100 miles.

TALENTS: Ghost Rider has Marksman and Horsemanship talents.

CONTACTS: Ghost Rider is one of the Rangers.

BACKGROUND: Hamilton Slade's ancestors had fought crime in the Old West, as the Ghost Rider. While exploring an Indian burial mound, Hamilton Slade discovered the costume and was possessed by a mystic spirit.

MENTOR

Alars of Titan

F	Ty	(6)	Health: 146
A	Gd	(10)	
S	Rm	(30)	Karma: 100
E	Un	(100)	
R	Rm	(30)	Resources: Mn
I	Rm	(30)	
P	In	(40)	Popularity: 0/(100)

KNOWN POWERS:

Immortality: Mentor is immortal and does not die if reduced to 0 Health and Shift 0 Endurance.

Invulnerabilities: Mentor is invulnerable to heat, cold, energy, electricity, radiation, toxins, disease, and aging. He can be affected by slams and stuns, and is vulnerable to mental and magical attacks.

Life Support: Mentor has Class 1000 Life Support, and can survive to outer space indefinitely.

Flight: Mentor can fly at Monstrous speed in atmosphere, and Class 1000 in space.

Cosmic Energy Manipulation: Mentor has this power at Monstrous rank. He has used it to fire Monstrous Force bolts.

TALENTS: Mentor has Leadership talent.

CONTACTS: Mentor is the ruler of Titan, and is assisted by ISAAC, a computer with Monstrous Reason and information resources. Mentor was allied with the Avengers and Mar-Vell against Thanos.

BACKGROUND: While wandering the solar system, Alars found on Titan an Eternal colony devastated by civil war. He took the last survivor, Sui-San, as his wife, and the two rebuilt and repopulated the world. The new colony was demolished by Thanos, Mentor's renegade son. Mentor helped to defeat Thanos, then began rebuilding again. His youngest son, Starfox, became an Avenger.

PALADIN

Real Name Unrevealed

F	Ex	(20)	Health: 100
A	Ex	(20)	
S	Rm	(30)	Karma: 36
E	Rm	(30)	
R	Gd	(10)	Resources: Ex
I	Ex	(20)	
P	Ty	(6)	Popularity: 5

KNOWN POWERS:

Body Armor: Paladins thickly quilted Kevlar body-suit provides Excellent protection from physical attacks and Good Protection from fire.

Helmet: In addition to the Kevlar armoring, Paladin's helmet contains the following:

- Polarized goggles, providing Excellent protection for vision.
- Infra-red lenses, which can be fitted to the goggles, providing Good Infravision.
- A sealable Plexiglas facemask, with a 1-hour air supply.

Stun Gun: This is a highly-advanced pistol that emits a stun ray of Incredible intensity to a range of 7 areas. The gun is equipped with a safety-catch (possibly keyed to fingerprints) that prevents anyone but Paladin from using the gun.

TALENTS: Paladin is a Weapon Specialist with his stun-gun (+2 CS). He uses Martial Arts B and C in combat as well. Paladin also has Detective/Espionage and Languages talents. More talents may be disclosed as the mysteries of Paladin's background are revealed.

CONTACTS: Paladin has a large number of floating contacts. He hires himself out only to legitimate employers who need something protected or a certain criminal caught. He has worked with Daredevil, the Wasp, and the East Coast Avengers on occasion. On one case, he struck up a shipboard romance with the Wasp and is still quite friendly with her, a development which disturbs the Black Knight.

BACKGROUND: Nothing is known of Paladin's life before he became an adventurer. The origin of his strength, his weapon, and his equipment is also unknown. He serves as a highly-priced mercenary, but not for criminal goals.



RED WOLF

Will Talltrees

F	Rm	(30)	Health: 80
A	Ex	(20)	
S	Gd	(10)	Karma: 60
E	Ex	(20)	
R	Gd	(10)	Resources: Ty
I	In	(40)	
P	Gd	(10)	Popularity: 5

KNOWN POWERS:

Animal Communication and Control: This power is limited to Lobo, a wolf who is Red Wolf's companion. Communication is at incredible rank.

Weapons: Red Wolf carries two weapons; a 6-foot-long wooden coup-stick (fighting staff) and a flint-blade tomahawk. The coup-stick can be used as a bludgeon or as a javelin (Blunt Thrown). The tomahawk inflicts either 10 points Edged damage, or 16 points Blunt damage if the flat of the blade is used. The wolf-spirit enchantment gives both weapons Remarkable material strength.

Wolf, Lobo: Lobo is an ordinary wolf raised and trained by Red Wolf.

Tracking: Red Wolf has Excellent ability in tracking.

TALENTS: Red Wolf uses Wrestling, Thrown Weapons, and Acrobatics skill in combat. He has had Military training and has worked as a construction worker.

CONTACTS: Red Wolf is a member of the Rangers. The Avengers helped him avenge the murder of his family.

BACKGROUND: The Red Wolf is the traditional protector of the Cheyenne tribe and Will Talltrees was familiar with the legends by the time he grew up. After his father was murdered, he performed a mystic ceremony and became possessed by Owayadata, the Wolf Spirit. After avenging his family's murder he became a solo adventurer. Upon receiving a distress call from Rick Jones, Red Wolf and four other heroes rescued the Hulk from the evil Corruptor. The five heroes banded together as the loosely-organized Rangers. The Rangers recently fell under demonic influence and fought the West Coast Avengers, who managed to free the Rangers.

SHOOTING STAR

Victoria Star

F	Gd	(10)	Health: 66
A	Rm	(30)	
S	Ty	(6)	Karma: 18
E	Ex	(20)	
R	Ty	(6)	Resources: Ty
I	Ty	(6)	
P	Ty	(6)	Popularity: 10

KNOWN POWERS:

Pistols: Shooting Star carries two pistols that resemble revolvers, but fire star-shaped stun-pellets of Remarkable intensity. These guns are non-lethal (treat Kill results as Stun). Each pistol holds 30 pellets.

Gyro-Boots: These allow Star to be safely borne aloft by tornadoes created by her partner, Texas Twister.

TALENTS: Shooting Smile a Weapon Specialist with her unique pistols (+2 CS). She has Horsemanship talents and is skilled in Acrobatics and Tumbling.

CONTACTS: Shooting Star is the partner and lover of Texas Twister. Both are members of the Rangers.

BACKGROUND: Shooting Star's guns and boots were created for use in her rodeo act. She and the other Rangers banded together to fight the Hulk, but did not remain an organized team. Later, a demon serving Master Pandemonium (who was investigating Firebird) impersonated Star and made sure that the Rangers would remain unorganized. The demon was revealed when it forced the Rangers to attack the West Coast Avengers. The whereabouts of the true Star are unknown.

TEXAS TWISTER

Drew Daniels

F	Gd	(10)	Health: 66
A	Ex	(20)	
S	Ty	(6)	Karma: 18
E	Rm	(30)	
R	Ty	(6)	Resources: Ty
I	Ty	(6)	
P	Ty	(6)	Popularity: 10

KNOWN POWERS:

Body Armor: Texas Twister's tough flesh provides Good body armor.

Tornado Generation and Control: Texas Twister can create tornadoes that cause up to Amazing Force damage, and move at Amazing ground speed (8 areas per round). The maximum size of the tornado is 8 areas. Usually, the Texas Twister's body is within the tornadoes he creates, but he can create a tornado up to 6 areas away. He can create smaller or less intense tornadoes, or create one that centers on a specific part of his body. The following are established power stunts:

- Fight within the tornado.
- Surrounding his fist with a small tornado, enabling him to punch with Remarkable strength.
- Creating tornadoes around people or objects, grappling them with Amazing strength.

TALENTS: Texas Twister has Acrobatics, Tumbling, Horsemanship, and Martial Arts B talents.

CONTACTS: Texas Twister is a member of the Rangers, and the lover and rodeo partner of Shooting Star. He's a former S.H.I.E.L.D. Super-Agent.

BACKGROUND: Former cowboy Daniels gained his powers when he was caught in a tornado tainted with toxic waste and radioactivity. After an unsuccessful interview with the Frightful Four, he became a S.H.I.E.L.D. Super-Agent until that program was cancelled. He and Shooting Star became partners in a successful rodeo act and later formed the Rangers along with Firebird, Ghost Rider, and Red Wolf. (The Rangers are an example of a team that could benefit from an Avengers Experimental Franchise, as explained in the adventure.)

VILLAINS

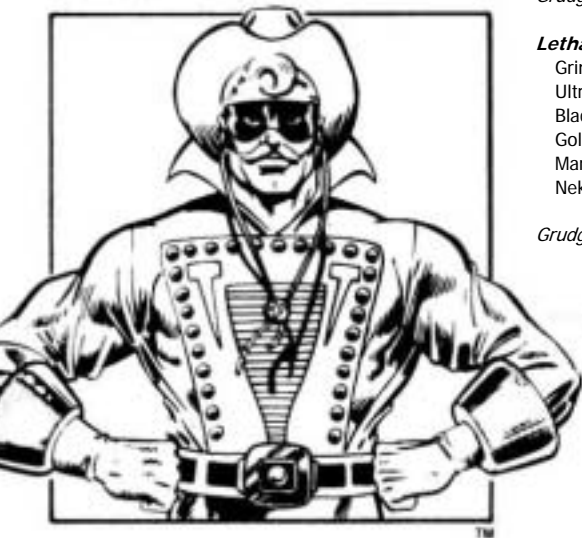

Notes on the Villains

If the Avengers were lucky, they'd only have idiots like Fabian Stankowicz to fight (see page 64). But they're not lucky. The Earth's Mightiest Heroes have enemies appropriate to their stature. Handling events is easy for the Judge when the Avengers face a single powerful foe, but things can become complicated when the Avengers battle a team of villains with more players than the Green Bay Packers. Here's a list of the various villainous super-teams, including their members and any special grudges that any of them have. Villains often attempt to satisfy these grudges, even at the expense of the villain-leader's Master Plan, which is one of the reasons the Avengers usually win. The villains' grudges often border on obsessive or insane behavior.

The Korvac War

Korvac (aliases Michael, The Enemy)
Carina
Captain Mar-Vell (Avengers ally)
Collector (Avengers ally)
Guardians of the Galaxy (Avengers allies)
Ms. Marvel (Carol Danvers, Avengers ally)

The Kree-Skrull War

Ronan the Accuser (Kree leader)
Emperor Dorrek (Skrull leader)
Captain Mar-Vell (Avengers ally)
H. Warren Craddock (Skrull spy)
Mandroids (agents of H. W. Craddock)
Nick Fury (Avengers ally)
Rick Jones (Avengers ally)
Super-Skrull (agent of Emperor Dorrek)
Supreme Intelligence (enemy of Ronan)
The Inhumans (neutral race)

Lethal Legion I

Grim Reaper (leader)
Goliath
Living Laser
Man-Ape
Swordsman

Grudges: Grim Reaper -- Vision, Wonder Man

Lethal Legion II

Grim Reaper (leader)
Ultron-12 (ally)
Black Talon
Goliath
Man-Ape
Nekra

Grudges: Grim Reaper -- Vision, Wonder Man

Masters of Evil I

Baron Heinrich Zemo (leader)
Black Knight (Nathan Garrett)
Enchantress
Executioner
Melter
Radioactive Man

Grudges: Baron Zemo -- Captain America

Masters of Evil II

Ultron-5 (alias Crimson Cowl, leader)
Black Knight (Dane Whitman, heroic infiltrator)
Klaw
Melter
Radioactive Man
Whirlwind

Grudges: Ultron-5 -- Giant-Man, Wasp

Masters of Evil III

Egghead (leader)
Beetle
Moonstone
Scorpion
Shocker
Radioactive Man
Tiger Shark
Whirlwind

Grudges: Egghead -- Henry Pym; Scorpion -- J. Jonah Jameson, Spider-Man

Masters of Evil IV

Baron Helmut Zemo (leader)
Absorbing Man
Blackout
Goliath
Grey Gargoyle
Mr. Hyde
Moonstone
Screaming Mimi
Tiger Shark
Titania
Whirlwind
Wrecking Crew
Yellowjacket

Grudges: Baron Zemo -- Captain America; Mr. Hyde -- Cobra (villain)

The Thanos War

Thanos (leader)
Blood-Brothers
Controller
Super-Skull
Captain Mar-Vell (Avengers ally)
Drax the Destroyer (Avengers ally)
Mentor (Avengers ally)
Moondragon (Avengers ally)
Rick Jones (Avengers ally)
Starfox (Avengers ally)

ABSORBING MAN

Carl "Crusher" Creel

F	Ex	(20)	Health: 56
A	Ty	(6)	
S	Gd	(10)	Karma: 14
E	Ex	(20)	
R	Pr	(4)	Resources: Pr
I	Pr	(4)	
P	Ty	(6)	Popularity: -20

KNOWN POWERS:

Material and Energy Duplication: The Absorbing Man can take on the properties of any material he touches, giving him Strength, Endurance, and Body Armor of rank equal to the material strength of the object touched; his Health is increased if his abilities increase, but does not decline if he absorbs from an object with a material strength rank lower than his normal abilities. The upper limit for the transformation is Unearthly; if he touched Captain America's shield, his abilities would rise to Unearthly, not Class 3000. He can remain in a particular transformation as long as he wishes. If the object touched holds some form of energy (such as a battery or a blast furnace), he absorbs the energy properties as well. Creel is not hurt by this energy and can retain it for up to 10 rounds. He can also absorb shapes and sizes from objects; touching a hammer would give him hammer-like fists, by touching a building, he can enlarge himself to equal its height.

Power Absorption: Creel can absorb superhuman abilities and powers in the same way he absorbs from inanimate objects. However he does not absorb the ability to control them, and so cannot perform most power stunts. For example, he could gain energy powers by touching Captain Marvel, but he could not change into different types of energy, as she can. Unlike Rogue, Creel only copies abilities, he does not steal them.

Life Support: If parts of his body are severed, the Absorbing Man can reattach them by holding them in place and transforming to human form.

Weapon: The Absorbing Man carries a prisoner's ball-and-chain that transitions as he does if he is holding it.

TALENTS: None

CONTACTS: The Absorbing Man is a member of the fourth Masters of Evil.

BACKGROUND: Loki used Asgardian magic to give Creel the power to battle Thor.

ARES

Ares of Olympus

F	Un	(100)	Health: 295
A	Ex	(20)	
S	Mn	(75)	Karma: 42
E	Un	(100)	
R	Ty	(6)	Resources: Rm
I	Ty	(6)	
P	Rm	(30)	Popularity: -15

KNOWN POWERS:

Body Armor: Ares has Excellent body armor. In battle he wears armor that provides Incredible protection against physical and energy attacks.

Immortality: Ares is a true immortal and does not die if reduced to 0 Health or Shift 0 Endurance. This applies only to Earth's dimension. When in Olympus or other dimensions, Ares can be slain.

Resistance: Ares does not age, and has Class 1000 resistance to disease.

Weapons: Ares uses weapons made of Class 1000 adamantium; his favorite ones are spears and axes. Ares inflicts Unearthly edged damage with these weapons.

TALENTS: Ares is a Weapons Master with all weapons used by the ancient Greeks (+1 CS). He also has Leadership talent.

CONTACTS: Ares is an important member of the Olympian pantheon. Ares' partners to his schemes of conquest have been his uncle Pluto and the Asgardian Enchantress.

BACKGROUND: Ares was the war-god of ancient Greece, encouraging battle and slaughter for its own sake. In ancient times, he formed a deep hatred for Hercules and for Athena, the goddess of battle prowess. Unhappy with Zeus' decision to forsake human worshippers, Ares has assisted Pluto in efforts to seize power. He has also attempted to start wars on Earth. Hercules and the Avengers have been frequent opponents. Ares' courage is not the equal of his battle skill, and he is often reluctant to fight those who are his equals, seeking out weaker opponents instead.

ARMADILLO

Antonio Rodriguez

F	Ex	(20)	Health: 100
A	Gd	(10)	
S	In	(40)	Karma: 18
E	Rm	(30)	
R	Ty	(6)	Resources: Ty
I	Ty	(6)	
P	Ty	(6)	Popularity: -10

KNOWN POWERS:

Body Armor: Armadillo's hide provides Amazing protection against physical attacks and Remarkable protection against energy attacks.

Multiple Resistances: Armadillo's hide provides Excellent resistance against fire and heat, Excellent resistance to cold, and Excellent resistance to corrosives.

Claws: Armadillo has natural claws on his hands and feet. These Amazing strength material weapons cause Incredible Edged damage against living targets.

Digging: Armadillo can travel underground, using his claws to dig a tunnel. He can dig through materials of Incredible strength material or less.

Climbing: Armadillo can climb vertical surfaces by using his claws to gouge handholds and footholds as he climbs. His claws can penetrate materials of Incredible rank. The need to make handholds limits Armadillo to the normal ground movement rate when climbing.

TALENTS: Armadillo has Wrestling talent.

CONTACTS: Armadillo was a pro in the Unlimited Class Wrestling Federation.

BACKGROUND: When his wife Bonita was stricken with an undiagnosed disease, the desperate Rodriguez took her to the criminal scientist Dr Karl Malus. Malus was doing research into superhuman abilities and offered to cure Bonita if Antonio agreed to become a test subject. Rodriguez acquired claws, armor, and an animal-like appearance as a result of Malus' experiments. After Bonita was cured, Rodriguez became a wrestler, hoping to earn a fortune for his wife's sake. When he discovered that his wife was having an affair, he went on a rampage through downtown Manhattan and unsuccessfully tried to commit suicide.

ARNIM ZOLA

F	Gd	(10)	Health: 60
A	Ex	(20)	
S	Gd	(10)	Karma: 100
E	Ex	(20)	
R	In	(40)	Resources: Ex
I	Gd	(10)	
P	Am	(50)	Popularity: -20

KNOWN POWERS:

Body Armor: Zola's bio-engineered body provides Excellent body armor.

Clone Bodies: Zola is able to create and duplicate bodies into which he can mentally project his life-force, thus enabling him to escape capture or death.

Bio-Constructs: Zola can construct creatures using animal, human, or superhuman genetic material. Such creatures have no Reason, Intuition, or Psyche and are controlled telepathically. Constructs based on animals or humans have a maximum Health of 100 and no ability can exceed Remarkable. Constructs based on a specific superhuman being have a maximum Health of 200, and a -1 CS to all FASE abilities and power ranks; among superhuman powers, only Resistances and Body Alterations can be duplicated. Following is the most Powerful construct, the "Pseudo-Hulk."

F	A	S	E	Health
Ex	Ty	Mn	Am	151

Body Armor: Amazing

Resistance to Heat, Cold, Fire, Disease: Unearthly

ESP Box: This is the device through which Zola sees and hears, commands his constructs, and performs mental transfers between clone bodies. It has a range of 10 miles, and is constructed of Remarkable strength material. It is atop his shoulders.

TALENTS: Zola has Biochemistry, Genetics, Bio-engineering, and Repair/Tinkering skills.

CONTACTS: Currently none.

BACKGROUND: Zola's work is based on the science of the Deviants, recorded in papers brought back from the Crusades. After long patronage by the Nazis, the Hate-Monger, and the Red Skull, he became an independent. Zola's crimes are based on the desire to make new breakthroughs in bio-engineering.

ATTUMA

Attuma, Warlord of Atlantis

F	Rm	(30)	Health: 165
A	Gd	(10)	
S	Mn	(751)	Karma: 26
E	Am	(50)	
R	Ty	(6)	Resources: In
I	Gd	(10)	
P	Gd	(10)	Popularity: -5

KNOWN POWERS:

Body Armor: Attuma has Good body armor. Like other Atlanteans, his body is adapted to undersea living.

Resistance to Cold: Another common factor of Atlantean physiology, Attuma has Excellent Resistance to Cold.

Swimming: Attuma's strength allows him to swim faster than the normal Atlantean. He can swim at 3 areas per round.

Weapons: Attuma has often used swords and hammers made of Monstrous rank steel.

Bodyguards: Attuma will always have 11 to 20 Atlantean guards near him, armed with spears or concussion rifles.

LIMITATION: Water Breathing. As with other Atlanteans, Attuma suffocates out at water, similar to a human drowning in water.

TALENTS: Attuma is skilled in Underwater Combat (no penalties when fighting underwater), Sharp and Blunt Weapons, and Leadership.

CONTACTS: Attuma's current advisors are Lord Vashti, Lord Dara, and Warlord Thakos.

BACKGROUND: Attuma was the leader of a tribe of Atlantean barbarians. He got his chance to assume the throne of Atlantis during a civil war that followed the forced abdication of Prince Namor. Attuma suppressed almost all opposition, thus restoring a dictatorial peace. By exploiting Namor's love for the alien Marrina, and by shrewd propaganda, Attuma managed to turn Atlantis against the Sub-Mariner. Namor, the Avengers, and Alpha Flight recently attacked Atlantis to free Marrina from cruel imprisonment, but Namor reluctantly accepted Attuma as ruler of Atlantis.



BARON ZEMO I

Baron Heinrich Zemo (dead)

F	Ex	(20)	Health: 50
A	Gd	(10)	
S	Gd	(10)	Karma: 54
E	Gd	(10)	
R	In	(40)	Resources: Rm
I	Pr	(4)	
P	Gd	(10)	Popularity: -20

KNOWN POWERS:

Ionic Ray Treatment: This was used to give Wonder Man and Goliath their powers. For full affect, the treatment must be adjusted for the subject's genetic structure, yielding the following permanent effects: Fighting, +1 CS, Agility +2 CS, Strength, +6 CS, Endurance, +6 CS. If used on a different subject, the treatment will yield the same results, but will decline within 1-10 months to the following levels. Strength +3 CS, Endurance, +5 CS; these are permanent. In either case, Fighting and Agility cannot exceed Amazing, while Strength and Endurance cannot exceed Unearthly. In addition to the above adjustments, any subject of the treatment gains the following powers:

- Body Armor: Amazing
- Invulnerability: Heat, Cold
- Life Support: Class 1000

Adhesive X: This liquid adhesive solidifies in 1 round and bonds with Unearthly strength. A solvent for Adhesive X was developed by the villainous Trapster.

Lasers: Zemo developed practical lasers decades before other scientists did. He normally carried a laser pistol and built laser cannons in WW II (see stats in the Players Book, pgs. 42-43). His laser satellite, which was never used, had Monstrous intensity and Shift Z range.

LIMITATION: Zemo's mask was pasted to his head and could never be removed.

TALENTS: Zemo used Martial Arts A and B, and had Chemistry, Biology, Engineering, and Electronics skills.

CONTACTS: Zemo was a leading scientist of the Third Reich and worked with Arnim Zola and the Red Skull. After Captain America's revival Zola formed the first Masters of Evil and he was killed in personal combat with Captain America. For the full story of the Zemo family, see Baron Zemo II.

BARON ZEMO II

Baron Helmut Zemo

F	Gd	(10)	Health: 46
A	Ty	(6)	
S	Gd	(10)	Karma: 40
E	Ex	(20)	
R	Ex	(20)	Resources: Rm
I	Gd	(10)	
P	Gd	(10)	Popularity: -10

KNOWN POWERS:

Adhesive X: Young Zemo was able to re-create his father's discovery, using notes he had left behind.

Laser: Like his father, Helmut Zemo often carries a laser pistol or other laser weapons.

LIMITATION: Helmut Zemo's face is hideously scarred, caused by accidental immersion in a vat of boiling Adhesive X.

TALENTS: Helmut Zemo uses Martial Arts B in combat. He also has Chemistry and Engineering skills. Helmut is probably not capable of making any great scientific breakthrough, but has duplicated some of his father's discoveries. Whether or not young Zemo can recreate his father's supreme achievement, the ionic ray treatment, is unknown.

CONTACTS: Zemo is the leader of the fourth Masters of Evil. Prior to this, he had been the ally of Primus (a creation of Arnim Zola), the Red Skull, and the Skull's daughter, Mother Superior.

BACKGROUND: While fighting the elder Zemo in World War II, Captain America shattered a vat of Adhesive X. Zemo was accidentally caught in the deluge and his mask was permanently bonded to his head. Zemo became insanelly obsessed with defeating Cap, and was the prime agent in a scheme that ended in the death of Cap's partner Bucky Barnes, and also resulted in Cap's being placed in suspended animation. After the Avengers rescued Cap, Zemo formed the Masters of Evil to fight them. Zemo fought Cap and died when his own weapon caused an avalanche. Young Zemo blamed Captain America for all his father's misfortunes, and formed alliances with former Nazis to get revenge. While fighting Cap, young Zemo accidentally fell into a vat of boiling Adhesive X, permanently scarring his face. Recently, he organized a fourth Masters of Evil, larger than any previous group. Both father and son feel an obsessive hatred of Captain America, and this often clouds their judgment.

BLACK KNIGHT

Nathan Garrett (dead)

F	Ex	(20)	Health: 60
A	Ex	(20)	
S	Gd	(10)	Karma: 20
E	Gd	(10)	
R	Gd	(10)	Resources: Ex
I	Ty	(6)	
P	Pr	(4)	Popularity: -5

KNOWN POWERS:

Body Armor: Garrett wore a suit of chain mail armor that provided Good protection from physical damage.

Flying Horse: Garrett used his knowledge of genetics to create a mutated horse with wings. After Garrett's death, this horse was further mutated and is now owned by the Latverian Dreadknight.

F	A	S	E	R	I	P
Gd	Ex	Rm	In	Ty	Gd	Ty

Flight: Poor Speed (4 areas/round)

Weapons: The Black Knight's most important weapon was his energy-lance, which had several features:

- Laser-blast (Remarkable Energy attack), range 5 areas
- Shock-blast (Remarkable Force attack), range 5 areas
- Smoke-launcher (Excellent intensity), fills 1 area

Garrett sometimes used other medieval-style weapons that incorporated advanced technology.

TALENTS: Garrett was skilled In Biology, Genetics, and Engineering.

CONTACTS: The Black Knight was a member of the first Masters of Evil.

BACKGROUND: Nathan Garrett was a descendant of the original Black Knight of Camelot and inherited Garrett Castle, where the Ebony Blade was kept. Unable to draw the sword from its scabbard, Garrett nonetheless created the identity of the criminal Black Knight to finance his scientific research. While fighting Iron Man, the Black Knight fell from his airborne horse and was fatally injured. Before dying, Garrett repented and convinced his nephew Dane Whitman to become a heroic Black Knight.

BLACKOUT

Marcus Daniels

F	Ty	(6)	Health: 56
A	Ex	(20)	
S	Gd	(10)	Karma: 16
E	Ex	(20)	
R	Pr	(4)	Resources: Fb
I	Ty	(6)	
P	Ty	(6)	Popularity: -5

KNOWN POWERS:

Darkforce Manipulation: Blackout has this power at Excellent rank, and all power stunts listed in the Player's Book are established power stunts for Blackout. However, the only shapes he can currently create are simple geometric shapes (cubes, spheres, cylinders, planes).

LIMITATION: Blackout's sanity is tenuous, because of his accidental imprisonment in a Darkforce dimension. He suffers from delusions of persecution, and is likely to strike out blindly against anyone trying to imprison him

TALENTS: None.

CONTACTS: Blackout is currently a member of the fourth Masters of Evil, along with his former partner, the villainess Moonstone. She is able to calm his fears and manipulate him into serving her own purposes.

BACKGROUND: Dr. Abner Croft forced Daniels to submit to an experiment using Darkforce energy, from which Daniels gained his powers. He escaped from Croft and used his powers to commit crimes. Feeling the energies within him becoming unstable, Blackout returned to Croft's lab, using equipment there to stabilize his condition. He also hurled Dr. Croft into the Darkforce dimension, where he remains. The accidental destruction of the stabilizer stranded Blackout in the Darkforce dimension. Scientists at Project Pegasus accidentally released him, and Blackout formed his partnership with Moonstone, a prisoner at Pegasus. After two battles with the Avengers, both Moonstone and Blackout were stranded in the Darkforce dimension, but eventually escaped. After an unsuccessful attempt to increase Moonstone's power, both were re-imprisoned at Project Pegasus. While being transferred to a new prison, Blackout was freed by agents of Baron Zemo II, and recruited into the fourth Masters of Evil.

BLACK TALON

Real Name Unrevealed

F	Ty	(6)	Health: 42
A	Ty	(6)	
S	Gd	(10)	Karma: 56
E	Ex	(20)	
R	Ty	(6)	Resources: Ty
I	Ex	(20)	
P	Rm	(30)	Popularity: -10

KNOWN POWERS:

Necromancy: The Black Talon can create zombies (also called zuvembies), the reanimated bodies of the dead. To do so, Black Talon must perform a mystical ceremony in the presence of the corpse to be reanimated. As many as 20 zombies can be created at one time. A zombie created from the body of a normal man has the following statistics:

F	A	S	E	R	I	P
Ty	Pr	Ty	Gd	Fb	Pr	Fb

Body Armor: Excellent
Immunities: Heat, Cold, Radiation, Toxins, Disease, Mental Attacks

The Black Talon can telepathically control zombies in his presence. On their own, the zombies can obey simple verbal instructions. Other than this, their intelligence is almost nil. The Black Talon's necromancy powers are of Monstrous rank.

Weapons: Black Talon sometimes carries simple hand-to-hand weapons, such as a sword, dagger, or club.

TALENTS: The Black Talon is well-versed in Occult Lore, especially in voodoo.

CONTACTS: The Black Talon was the former partner of the Grim Reaper and Nekra.

BACKGROUND: Nothing is known of Black Talon's life before he became a voodoo master. The Black Talon assisted the Grim Reaper in two attacks on the Avengers. Both schemes failed, and on the second occasion, the Black Talon became disgusted by the Grim Reapers racist attitudes and abandoned the partnership. Before deserting the Reaper, the Black Talon taught the art of creating zombies to Nekra, the Reaper's lover.



COLLECTOR

Taneleer Tivan

F	Ty	(6)	Health: 62
A	Ty	(6)	
S	Ex	(20)	Karma: 130
E	Am	(30)	
R	Am	(50)	Resources: Un
I	Rm	(30)	
P	Am	(50)	Popularity: 0

KNOWN POWERS:

Body Armor: The Collector's dense flesh gives him Good body armor

Immortality: The Collector is immortal and does not die if reduced to 0 Health and Shift 0 Endurance.

Invulnerabilities: The Collector is Invulnerable to heat, cold, energy, electricity, radiation, toxins, disease, and aging. He can be affected by slams and stuns and is vulnerable to mental and magical attacks.

Cosmic Energy Control: The Collector has this power at Uearthly rank but has neglected to fully develop it. He can use it to perform Magnetic, Electrical, Light, or Gravity Manipulation, and can fire bolts of Force or Energy. However, because of the Collector's lack of practice, treat any use of this power as a Power Stunt requiring a green FEAT result and the expenditure of 100 Karma.

Precognition: The Collector has Class 1000 precognitive powers, but they are intermittent and can only warn him of beings or events that threaten the safety of the entire universe. He must make a successful Psyche FEAT roll to determine whether the vision of the future applies to this universe or to an alternate universe.

Sidearms: The Collector always carries 14 weapons of various types on his person at all times. These weapons have a maximum of Monstrous rank or effect and are designed to stun or capture opponents, rather than kill them. (Defeated opponents often end up in the zoological collection.)

Starship: This gigantic vessel is a star-spanning museum and zoo, containing a vast collection of technology and life-forms from the worlds the Collector has visited.

Control	Speed	Body	Protection
In	Cl 3000	In	In

Collection Technology: The vast stockpile of devices aboard the Collector's ship allows him

to perform most powers listed in the Players' Book (except Body Control or Body Alteration powers) at ranks ranging from Incredible to Uearthly. The devices are readily accessible, but if the Collector is hard pressed (dodging high-tech arrows or magical hammers, for example) he must make a green Reason FEAT roll to find an item of a given type (such as a weapon); if he is looking for a specific device, he must make a red Reason FEAT roll. Devices he is known to have include:

- Temporal Assimilator, a portable time-travel machine of Amazing rank
- Battle Armor, provides Incredible protection from physical and energy attacks; Incredible Flight powers
- Stun Globe: Amazing intensity stunning
- Inhibitor and Confinement Devices, a diverse collection of all ranks and intensities used in the zoo

Collection, Animal: The creatures in the Collector's zoo can be handled by the following guidelines: maximum Health, 200; maximum FASE ability, Monstrous; maximum Reason, Remarkable; maximum number of Powers, 3.

TALENTS: The Collector has an extensive knowledge of biology and technology.

CONTACTS: The Collector is one of the Elders of the Universe, and he occasionally associates with his brother Elders. The Collector's daughter, Carina, betrayed him and sided with Korvac.

BACKGROUND: The Elders of the Universe are among the oldest living beings. Each of them must devote his life to a single life-long occupation to retain his Immortality. The Collector chose to preserve life-forms and technology so he could repopulate the universe if it were devastated by any of the cosmos threatening menaces whose schemes he foresaw. The Collector has opposed the Avengers several times. During the Korvac war, Korvac killed the Collector to prevent him from warning the Avengers about Korvac's plans. The Collector was resurrected later when the Grandmaster, another Elder, won a contest with Death itself.

CONTROLLER

Basil Sandhurst

F	Rm	(30)	Health: 110*
A	Rm	(30)	
S	Ex	(20)*	Karma: 30
E	Rm	(30)	
R	Ex	(20)	Resources: Ex
I	Pr	(4)	
P	Ty	(6)	Popularity: -5

* These values are changeable; see below.

KNOWN POWERS:

Body Armor: The Controller's exoskeleton gives him Remarkable body armor.

Slave-Disc: This is a coin-sized Mind Control device of Amazing Intensity. It must be attached to the victim's head to function. The disc gives the Controller a telepathic link to all controlled slaves and the ability to telepathically command them from any distance. When the disc is attached, the victim can resist its effects (and remove the disc) by making a successful Psyche FEAT roll against Amazing intensity. The disc can safely be removed from a controlled slave only if the Controller is defeated; if the disc is wrenched off, the slave must make a successful Endurance FEAT roll against Amazing intensity or begin losing Endurance ranks.

Enhanced Strength: The disc also converts a slave's psychic energy to Strength for the Controller. The Psyche rank of each slave is treated as a Strength rank and all Strengths are added together. Thus, 100 slaves of Typical Psyche (200 pounds equivalent) allows him to lift 20,000 pounds (Incredible Strength).

Mental Powers: The Controller gains any Mental Powers possessed by his slaves.

LIMITATION: The slave-disc cannot affect a mind that contains two separate personalities.

TALENTS: Sandhurst is a skilled Engineer and has Repair/Tinkering skill.

CONTACTS: The Controller was a lackey of Thanos.

BACKGROUND: A chemical explosion crippled Sandhurst, who built his mental energy-powered exoskeleton with automated technology.

DEATHURGE

F	Gd	(10)	Health: 121
A	Rm	(30)	
S	Ty	(6)	Karma: 90
E	Mn	(75)	
R	Gd	(10)	Resources: None
I	In	(40)	
P	In	(40)	Popularity: -10

KNOWN POWERS:

Invulnerabilities: Deathurge is invulnerable to heat, cold, electricity, toxins, and disease.

Phasing: Deathurge has Unearthly phasing powers, and can apparently remain intangible indefinitely. It is unknown if its phasing disrupts electrical systems.

Flight: Deathurge can fly at up to Class 3000 speeds. It has successfully eluded Captain Marvel in flight.

Precognition, Death: Deathurge has Monstrous precognition powers, but its visions are limited to the upcoming death of a character, usually the death of Deathurge's master.

Death Weapon: This is apparently drawn from the substance of Deathurge's body, and most often resembles a spear. It is intangible until it strikes its intended target. The intended target must make a successful FEAT roll against Shift Y intensity or begin losing Endurance ranks; as the target loses ranks, a blackness spreads from the bloodless wound until it covers the whole body. If the weapon passes through a living being other than the mended target, the victim is attacked by Amazing intensity cold, but will not die. This weapon is not affected by any form of physical body armor.

TALENTS: Deathurge is a Weapon Specialist with its death weapon (+2 CS).

CONTACTS: Deathurge was once a "lackey" of Maelstrom's.

BACKGROUND: Deathurge's origin is unknown, nor is it known whether Deathurge is a living being. Its role seems to be as an executioner of those who have unconsciously sought death, but have eluded it by some means. Deathurge has "served" villains as a lackey, only to turn on them when the hour of death is at hand.

EGGHEAD

Elihas Stem (dead)

F	Pr	(4)	Health: 20
A	Ty	(6)	
S	Pr	(4)	Karma: 32
E	Ty	(6)	
R	Ex	(20)	Resources: Rm
I	Ty	(6)	
P	Ty	(6)	Popularity: -20

KNOWN POWERS:

Technology: Egghead's many inventions included insect control devices, orbiting laser satellites, mind control devices, and robots.

TALENTS: Egghead was a scientific genius in diverse fields, including Nuclear Physics, Robotics, Electronics, and Biology. He also had Engineering and Repair/Tinkering skill.

CONTACTS: Egghead was the leader of the second Masters of Evil. He was also a partner of the Mad Thinker and the Puppet Master.

BACKGROUND: Egghead was an atomic scientist who lost his Government job when he treasonously tried to sell nuclear secrets. Organized criminal elements agreed to help him stay out of prison if he defeated the Ant-Man (Henry Pym). Egghead failed, and became obsessed with hatred of Pym and the desire to humiliate him. Egghead was an enemy of Pym and the Avengers for years. His most heinous plot occurred after Pym's expulsion from the Avengers. Egghead offered the impoverished Pym \$500,000 to attach a robotic arm to his niece, Trish Starr. She had lost an arm because of one of Egghead's earlier plots, and he claimed he wished to make amends. When the arm was attached, it allowed Egghead to control Trish's mind. Egghead blackmailed Pym into a plan to steal adamantium from the US Government.

As Yellowjacket, Pym attacked SAC headquarters, but was caught by the Avengers. At his trial, Pym was abducted by the Masters of Evil. Egghead then forced Pym to work on an experiment to retard aging. Pym secretly built a harness equipped with powerful weapons and told Egghead it was an anti-aging apparatus. The suspicious Egghead forced Pym to test it, and Pym defeated the Masters of Evil single-handedly. As Pym left, Egghead intended to shoot him, but Hawkeye arrived and fired an arrow into Egghead's weapon, which exploded and killed him.



ENCHANTRESS

Amora of Asgard

F	Ex	(20)	Health: 130
A	Ex	(20)	
S	In	(40)	Karma: 100
E	Am	(50)	
R	Gd	(10)	Resources: Am
I	In	(40)	
P	Am	(50)	Popularity: 20

KNOWN POWERS:

Eldritch Kiss: The Enchantress can fill a man's mind with passionate love and blind loyalty with a kiss, even if the victim knows that the Enchantress is an enemy. The effect lasts about a week. When kissed, the victim can avoid the effect by making a successful Psyche FEAT roll against Monstrous intensity magic for Asgardian victims, Unearthly intensity magic for mortal victims. The victim receives a Psyche FEAT roll to break the enchantment if the Enchantress' orders or actions place him in a situation in which he would lose Karma.

Magical Spells: The Enchantress is a Master of Asgardian Magic, although not the equal of Loki or Karnilla the Norn-Queen. She has the following spells always available:

- Magic Detection (P) - Amazing
- Psionic Detection (P) - Amazing
- Healing (P) - Remarkable
- Thought-Casting (P) - She can send, but not receive thoughts, Amazing
- Eldritch Bolt (U) - Energy or Force attack, Remarkable power and range
- Eldritch Shield (U) - as Personal Force Field, Remarkable
- Matter Control (U) - Air, Earth, Fire, Water, Remarkable
- Paralysis (U) - As Paralyzing Touch, but not constant, Remarkable
- Teleportation (U) - Monstrous
- Dimensional Aperture (D) - Allows travel between Asgard and Earth, Monstrous

TALENTS: The Enchantress has a wide knowledge of Occult Lore.

CONTACTS: The Enchantress' partners have included Loki, Ares, Arkon, Mandarin, the first Masters of Evil, and the Executioner, who was slavishly devoted to her. Her relationship with her sister Lorelei mirrors that of Thor and Loki.

BACKGROUND: The Enchantress is ruled by a desire for power, wealth, luxury, and pleasure. Although She helped Asgard in several cases (once foiling one of Loki's plots) Amora remains an unscrupulous, sometimes vicious opportunist.

ENCLAVE

Carlo Zota, Maris Morlak, Wladyslav Shinski

Carlo Zota

F	A	S	E	R	I	P
Ty	Gd	Ty	Ty	In	Gd	Gd

Health: 28 Karma: 60
Resources: Ex Popularity: -5

Maris Morlak

F	A	S	E	R	I	P
Ty	Ty	Ty	Gd	In	Ty	Ty

Health: 28 Karma: 52
Resources: Ex Popularity: -5

Wladyslav Shinski

F	A	S	E	R	I	P
Pr	Ty	Ty	Pr	In	Gd	Ex

Health: 20 Karma: 70
Resources: Ex Popularity: 0

KNOWN POWERS: None of the Enclave have superhuman powers. Their greatest discoveries are:

Teleportation Grid: For quick escapes from jail or from experiments gone wrong. The device was of Amazing rank and had a range of 2,000 miles. Objects and passengers could not be teleported from a distance unless fetched by a person sent from the grid. A kit-bashed version built by Shinski was of Remarkable rank and had a range of 100 miles.

Meteor Launcher: The Enclave bombarded Earth with meteors launched from the moon by electromagnetic accelerators, in an attempt to force Earth to attack the Inhumans. The meteors would have caused Unearthly Force damage and would have started fires (maximum intensity Amazing) had they struck Earth. The Avengers thwarted this scheme.

Molecular Blade: This device could cut through objects up to Monstrous material strength by severing molecular bonds.

Anti-Gravity Transmitter: This could lift objects with Remarkable strength.

Bio-Constructs: The Enclave made two separate attempts to create superhuman beings. Each time, the person was too powerful to control and tried to destroy the Enclave.

"Him" (later named Adam Warlock; dead)

F	A	S	E	R	I	P
In	In	Rm	Am	Gd	Ex	Rm

Health: 160 Karma: 60
Resources: Fb Popularity: 10

KNOWN POWERS (*also possessed by Her)

- *Body Armor (Good)**
- *Force Bolt (Incredible)**
- *Flight (Class 1000 in space, Shift X in atmosphere)**
- *Life Support (Class 1000)*.* Him can survive in outer space.
- *Protective Cocoon (Incredible material strength; Him has Monstrous Recovery powers when inside; can be created at will)**
- *Ability Enhancement (+1 CS to Strength or Endurance, duration 5 rounds)*
- *Soul Gem.* This was a gift from the High Evolutionary, with the following powers:
 - De-evolution of beings to ancestral forms (Amazing)
 - Absorbing the life force of dying beings

"Her" (also called Paragon)

F	A	S	E	R	I	P
Rm	Rm	Mn	Mn	Gd	Gd	Rm

Health: 210 Karma: 50
Resources: Fb Popularity: 0

KNOWN POWERS: (see Him for additional powers)

- *Invulnerability (heat, cold, radiation, toxins, disease, aging)*
- *Matter Control-Earth (Amazing ability, Poor area of effect)*

TALENTS: The combined knowledge of the Enclave spans all scientific talents. By specialty, Zota is trained in Electronics, Morlak in Nuclear Physics, Shinski in Genetics.

CONTACTS: The Enclave has supplied technology to HYDRA. Maximus, the mad Inhuman, was the Enclave's ally in two attacks on the Inhumans.

BACKGROUND: The Enclave's goal is world conquest through advanced technology. Their first installation, built with advanced Deviant technology, was damaged by Him and destroyed by Her. They made two attempts to conquer the technologically advanced Inhumans. Their second strike on the Inhumans was foiled by the Avengers. While investigating another Enclave plot, the Avengers rescued Marvel Girl from Jamaica Bay. An Enclave creation, Him was responsible for the death of Thanos.

EXECUTIONER

Skurge of Jotunheim and Asgard (dead)

F	Mn	(75)	Health: 245
A	Ex	(20)	
S	Am	(50)	Karma: 36
E	Un	(100)	
R	Gd	(10)	Resources: Gd
I	Ty	(6)	
P	Ex	(20)	Popularity: -20

KNOWN POWERS:

Body Armor: The Executioner's tough flesh provided Remarkable protection from physical attacks and Good protection from energy attacks.

Resistances: Skurge had Incredible Resistance to heat and Excellent Resistance to cold.

Enhanced Vision: The Executioner had Incredible eyesight.

Magical Axe: This double-bladed weapon was made of Unearthly material, and inflicted Amazing Edged damage. It was enchanted to have the following powers:

- Dimensional Aperture - The axe could cut through the barriers between dimensions, allowing travel between them. It could also cut through space, allowing through the heat of stars (Class 1000 intensity) or the cold of the void (Monstrous intensity).
- The axe could disrupt magical disguises and illusions, revealing the true identity beneath.

TALENTS: The Executioner was a Weapon Specialist with his axe (+2 CS).

CONTACTS: The Executioner was a member of the first Masters of Evil, and later worked for the Mandarin. He has also worked for Loki, and he was devoted to the Enchantress.

BACKGROUND: Skurge was the son of an Asgardian goddess and a storm giant. An outcast because of his mixed parentage, he fought the giants, Asgardians, and Thor's allies, the Avengers. For most of his adult life he was enslaved by the beauty of the Enchantress, but in the end she cruelly rejected him. Seeking relief in battle, he joined Thor's quest to free mortal souls trapped in Hel. There, he destroyed Naglfar, a huge ship that had taken millenia to build and which the dead would have used to invade Asgard. He nobly sacrificed himself by holding the escape route from Hel, the bridge Gjallerbru, alone against Hel's demons until the Asgardians escaped.

THE FIXER

Norbert Ebersol

F	Gd	(10)	Health: 32
A	Gd	(10)	
S	Ty	(6)	Karma: 70
E	Ty	(6)	
R	In	(40)	Resources: Rm
I	Ex	(20)	
P	Gd	(10)	Popularity: -10

KNOWN POWERS:

All the Fixer's powers derive from his weapons and technological devices.

Body-Suit: The Fixer's uniform is made of Kevlar cloth, giving Typical protection against physical attacks. The Fixer has insulated it to provide Excellent protection from fire and heat, and Incredible protection from electricity.

Battle-Vest: The vest itself is made of Remarkable strength material, and covers Fixer's entire torso. Its weapons are described individually.

Sonic Blaster: This shoulder-mounted weapon can amplify sound (including Fixer's voice) into an attack of Remarkable intensity that affects all in the target area. The sonic-blast has a range of 4 areas.

Electrification: The outer surface of the vest can be electrified, causing Incredible electrical damage to opponents who come in contact, as in Slugfest or Grappling combat.

Primary Launchers: There are two single-shot launchers in the upper part of the vest, one on each side. The launchers have a range of 5 areas, and will hold ammunition or devices of up to Incredible rank or intensity. One or both can be fired in a single round.

Secondary Launchers: There are six single-shot launchers evenly spaced below the primaries. They have a range of 5 areas and will hold ammo or devices of up to Remarkable rank. Up to three can be fired in a single round.

Gravity Clamp: Mounted in the belt, this steel clamp can be fired to a range of 2 areas. If it hits, the target is surrounded by a gravity field that Grapples with Incredible intensity.

Pistol: The Fixer's sidearm is a laser pistol the inflicts Excellent damage and has a range of 7 areas.

Electro-Knucks: Worn on each hand and used in Slugfest combat, an electro-knuck inflicts



Remarkable electrical damage.

Flight: Antigravity discs mounted in his boots allow the Fixer to fly at Shift X speed for up to 20 hours. He can hover, and since his flight is silent, he can Blindside unsuspecting opponents in flight.

Helmet: The Fixer's helmet provides Remarkable protection for vision and hearing. The helmet can be sealed and has a 3-hour air supply.

Psi-Screen Device: The Fixer originally built this for his partner Mentallo. If needed, the Fixer can easily install it in his own helmet. It provides an Incredible intensity psi-screen.

Ammunition: Used in the primary and secondary launchers, this includes all standard grenade types (fragmentary, smoke, tear gas, knockout gas, flash, concussion, and sonic). All ammo is limited to the intensity rank of the launcher.

Special Devices: The Fixer has used all of the following:

- Electronic Scrambler - Amazing intensity device, this can be either of two types: scrambles broadcast transmissions (TV, radio, radar, etc.), or scrambles internal circuitry when attached to target (computers, battlesuits, etc.)
- Guided Missile - can be standard, high-tech or high-speed, with any control type (see Players Book, p. 46). Payloads are limited to Amazing rank weapon or device.
- Brain-Scanner Helmet - As Incredible rank Mental Probe power
- Mind Control Pod - As Remarkable Mind Control, using broadcast waves controlled by Fixer's helmet
- Tunneling Device - As Digging power, of Incredible rank

TALENTS: The Fixer is an genius at Electronics and Engineering and also has Repair/Tinkering skill.

CONTACTS: The Fixer's longtime partner was the mutant telepath Mentallo. The Fixer has also worked for HYDRA and Prof. Anthony Power. The Fixer was recruited for the fourth Masters of Evil.

BACKGROUND: Feeling unchallenged by normal jobs, Ebersol turned to crime. His crimes are intended to finance innovations in technology which only his "great mind" can appreciate. He varies his arsenal often to surprise his foes.

GOLIATH

Erik Josten

F	Ex	(20)	Health: 145
A	Gd	(10)	
S	In	(40)	Karma: 14
E	Mn	(75)	
R	Ty	(6)	Resources: Gd
I	Pr	(4)	
P	Pr	(4)	Popularity: -10

KNOWN POWERS:

Growth: Goliath has Shift Y Growth Powers and can reach a maximum height of 60 feet. His Strength at normal height is Incredible, but as he grows beyond Incredible height (20 feet), his Strength and Health also increase until he reaches his maximum possible Strength rank, Uearthly, and maximum Health, 205. In combat, he prefers his maximum 60-foot height.

Body Armor: Goliath's irradiated flesh provides Amazing protection against physical and energy attacks, but not against mental attacks.

Invulnerabilities: Goliath is Invulnerable to Heat and Cold.

Life Support: Goliath no longer needs food, water or air to survive. He can survive in deep space for a short time with no ill effects.

TALENTS: None

CONTACTS: Jostens career defines the term "lackey." His Past bosses have included the Enchantress, the Black Widow (when she was brainwashed into villainy), the Red Skull, the Mandarin, Count Nefaria, the Grim Reaper, and Baron Helmut Zemo of the fourth Masters of Evil. Goliath's powers were augmented by the criminal scientist, Dr. Karl Malus.

BACKGROUND: The Enchantress, an ally of Baron Heinrich Zemo, subjected Josten to an ionic ray treatment Zemo had devised for Simon Williams, Wonder Man. For a time, Josten, who originally called himself Power Man, was as strong as Williams, but Josten's strength eventually declined (although still superhuman) and he worked as an ordinary criminal. Nefaria temporarily restored Jostens strength so that it could be siphoned to give Nefaria superhuman power. Dr. Malus was more trustworthy; he administered an extract of Henry Pym's growth serum that allowed Josten to become a giant and regain his original might. Josten then called himself Goliath, one of Pym's old identities.

GRANDMASTER

En Dwi Gast

F	Ty	(6)	Health: 42
A	Ty	(6)	
S	Gd	(10)	Karma: 130
E	Ex	(20)	
R	Am	(50)	Resources: Un
I	Rm	(30)	
P	Am	(50)	Popularity: 0

KNOWN POWERS:

Immortality: The Grandmaster is immortal and does not die if reduced to 0 Health and Shift 0 Endurance.

Invulnerabilities: The Grandmaster is Invulnerable to heat, cold, energy, electricity, radiation, toxins, disease, and aging.

Cosmic Energy Control: The Grandmaster has this Power at Shift X rank. He has developed several power stunts:

- Resurrection of dead mortal beings
- Death-power; the victim must make an Endurance FEAT against Shift X Intensity or lose Endurance ranks
- Temporary bestowal of resurrection and/or death-touch powers to mortals, at Uearthly rank
- Teleportation across dimensions, time, or space of himself, other people, or objects, at Shift X rank
- Energy or Force blast, at Shift X rank
- Forcefields of Shift X rank
- Destruction of a planet by means not revealed
- Permanent bestowal of super-powers on mortals (such as the Squadron Sinister) after following a pattern (such as the Squadron Supreme)

CONTACTS: The Grandmaster is one of the Elders of the Universe.

BACKGROUND: The Grandmaster chose to become the ultimate game player. After mastering millions of different games, he decided to challenge beings of great power to contests using superhuman champions as pawns. In a game against Kang the Conqueror, the Grandmaster's champions, the Squadron Sinister and the Invaders were defeated by Kang's champions, the Avengers. By winning a game against Death itself, the Grandmaster gained the ability to resurrect the Collector, a brother Elder slain by Korvac. When Death revealed that to resurrect the Collector, the Grandmaster would have to die, he felt obligated to claim his prize; the Grandmaster died and the Collector was restored to life.

GRAVITON

Franklin Hall

F	Pr	(4)	Health: 46
A	Ty	(6)	
S	Ty	(6)	Karma: 36
E	Rm	(30)	
R	Ex	(20)	Resources: Rm
I	Gd	(10)	
P	Ty	(6)	Popularity: -5

KNOWN POWERS:

Gravity Manipulation: Graviton has this power at Class 1000 rank. He can easily handle up to four effects per round and has maintained as many as six at once. If he tries to handle more than four effects in one round, he must make a successful power FEAT roll to maintain them all; failure means that all but the two most recent effects are cancelled. All power stunts listed for this power in the Player's Book are established power stunts for Graviton. Additional established power stunts include:

- Gravitic Force Bolts of Uearthly intensity and range
- Gravitic force field of Uearthly rank

TALENTS: Graviton was trained in Physics.

CONTACTS: Graviton has used a number of superhuman stooges in the past, including the Blank, Halflife, Quantum, and Zzzax.

BACKGROUND: Hall was working with an experimental teleportation machine when it exploded. His body's molecules were captured by an experimental anti-gravity device and when he managed to re-integrate himself, Hall discovered that he could control gravity. He decided to use his new powers to indulge his every desire. He now suffers from delusions of godhood but is not power-mad in the sense that Doctor Doom is. Graviton has fought both branches of the Avengers and his tactics are often unimaginative; he usually traps everyone on a large rock floatin at high altitude. Graviton's greatest weaknesses are chronic over-confidence and his futile pursuit of various attractive women who generally are not attracted to his personality.

GREY GARGOYLE

Paul Pierre Duval

F	Gd	(10)	Health: 110
A	Ex	(20)	
S	In	(40)	Karma: 36
E	In	(40)	
R	Ex	(20)	Resources: Gd
I	Gd	(10)	
P	Ty	(6)	Popularity: -15

KNOWN POWERS:

Body Transformation: By touching himself with his right hand, Duval transforms himself into a living statue. When in human form Duval has the following stats:

F	A	S	E	R	I	P
Ty	Ty	Ty	Ty	Ex	Gd	Ty

The transformation takes place in a single round. Duval can remain in stone form indefinitely and has little need for food or air.

Body Armor: The Grey Gargoyle's stone-like flesh provides Incredible protection from physical or energy attacks.

Resistances: In stone form, the Grey Gargoyle has Incredible Resistance to heat, fire, cold, and radiation.

Petrification Touch: The Grey Gargoyle transforms people or objects to stone for 1 hour by touching them with his right hand. Against people, this power works through clothes but touching someone in a battlesuit affects only the suit, not the wearer. Objects become Incredible material and the Grey Gargoyle often uses them as Slugfest weapons. This power is "non-conductive"; if two people were holding hands and the Grey Gargoyle touched one of them, only the one he touched would be affected. With really big objects, a volume of 10 Cubic yards can be transformed with a single touch. The Grey Gargoyle wears a special protective glove when he does not want to use this power.

TALENTS: The Grey Gargoyle is an expert in Chemistry, and uses Acrobatics and Martial Arts B and E in combat.

CONTACTS: The Grey Gargoyle is a member of the fourth Masters of Evil. He was an ally of A.I.M. for a while.

BACKGROUND: Duval gained his powers in a lab accident. He has fought Thor and the Avengers many times. In combat he uses creative tactics when outnumbered, but also enjoys a tough brawl.



GRIM REAPER

Eric Williams (dead)

F	Gd	(10)	Health: 36
A	Gd	(10)	
S	Gd	(10)	Karma: 18
E	Ty	(6)	
R	Ty	(6)	Resources: Ex
I	Ty	(6)	
P	Ty	(6)	Popularity: -10

KNOWN POWERS:

Battle Scythe: The scythe is made of Incredible steel. The blade inflicts 10 points of Edged damage or 16 points of Blunt damage if the flat of the blade is used. Other weapons are installed in the haft, as listed below.

- Force Blaster - Remarkable damage, range 5 areas
- Cerebral Stunner - Monstrous intensity stunning on touch; can be reversed to cancel the stun-effect
- Knock-Out Gas - Excellent intensity, fills one area
- Blade-Spinner - This has several effects, including an Excellent rank buzz-saw, Excellent protection against thrown objects and bullets; it used like a rotor, allows a safe fall from any height.

Zombie Powers: Nekra reanimated the Grim Reaper's dead body as a zombie that thought it was still alive. The zombie had the same ability ranks as the living Reaper, with some additional zombie powers.

- Excellent Body Armor versus physical or energy attack
- Invulnerability to heat, cold, radiation, toxins, and disease

TALENTS: The Grim Reaper was a Weapon Specialist with his scythe (+2 CS).

CONTACTS: The Grim Reaper was the leader of both Lethal Legions. The Grim Reaper and Nekra were lovers.

BACKGROUND: Eric Williams was the older brother of Simon Williams, Wonder Man. When Wonder Man died saving the Avengers from The Masters of Evil, Williams blamed the Avengers and swore to destroy them. As the Grim Reaper, he fought them numerous times, and he formed an insane hatred of the Vision and the returned Wonder Man, whom he considered mockeries of Simon. When he could no longer deny the humanity of the Vision and Wonder Man, the Grim Reaper committed suicide, but became a zombie. The spell was broken when the zombie realized that it was truly dead.

IMMORTUS

Real Name unrevealed

F	Ty	(6)	Health: 46
A	Gd	(10)	
S	Gd	(10)	Karma: 200
E	Ex	(20)	
R	Mn	(75)	Resources: Un
I	Am	(50)	
P	Mn	(75)	Popularity: 0

KNOWN POWERS:

His powers are derived from the advanced mentally controlled technology within his fortress in Limbo. It is unknown whether or not he himself has superhuman powers.

Invulnerability: While in Limbo, Immortus is invulnerable to heat, cold, radiation, toxins, corrosives, electricity, mental and emotional attacks, and disease. Immortus does not age.

Time Control: Immortus has Class 1000 abilities in time control. He can use a number of established power stunts.

- Teleporting people and objects from any time-era and location directly to Limbo or vice-versa
- Creating "turbulence" in the time-stream that can force time travelers to reach a specific destination chosen by Immortus
- Canceling the time-travel powers of any device used for that purpose, either temporarily or permanently

In addition, all Time Control power stunts listed in the Advanced Set are established power stunts for Immortus, except for Summoning Duplicates.

Energy Control: Immortus can use any Energy Control power at Amazing rank.

Mental Powers: Immortus can use the following, all at Monstrous rank: Image Generation, Mental Probe, Mind Control.

BACKGROUND: Immortus is one of the divergent doubles of the man who has used the identities of Kang, Rama Tut, and Scarlet Centurian. At the age of 75, Immortus abandoned his empire and retired to True Limbo. Three mysterious beings known as Time-Keepers assisted Immortus in learning the secrets of time, and they gave him the task of undoing the harm caused by his divergent doubles. Immortus prefers to manipulate others in serving as his unwitting agents, a role the Avengers have filled in the past. Unlike his other identities, there is only one Immortus.

KANG

Real Name Unrevealed

F	Ty	(6)	Health: 86
A	Gd	(10)	
S	Rm	(30)	Karma: Varies
E	In	(40)	
R	In/Am		Resources: Mn
I	Ty/Rm		
P	Gd/In		Popularity: -30

*Kang's time-travelling has resulted in a multitude of divergent doubles who are not identical in abilities. When using Kang as a villain, choose Reason, Intuition, and Psyche ranks that will make that particular Kang a challenge for his opponents.

KNOWN POWERS:

Body Armor: Kang wears full-body armor that provides Remarkable protection.

Resistances: The armor's life support system provides resistance to corrosives, toxins, and disease at a rank equal to Kang's Reason +1 CS (Amazing Reason yields Monstrous resistance). When wearing his armor, Kang does not need to eat or sleep.

Force Field: This force field provides protection at a rank equal to Kang's Reason +2 CS. It is effective against all physical, energy, and force attacks, but not against mental or magical attacks.

Blasters: These are built into Kang's gauntlets. They fire force or energy beams and have a range and intensity equal to Kang's Reason -2 CS.

Time Ship: The 11-ton time-ship can travel from era to era, and is also capable of interplanetary space travel.

Control	Speed	Body	Protection
Am	Cl 1000	Am	Am

Some Kangs have remote time-control circuitry in their armor, allowing them to use the time ship's machinery to travel in time without actually being aboard.

Growing Man (not used by all Kangs): These androids absorb the kinetic energy from physical blows and force beams, converting it to size and strength. Normal statistics follow:

F	A	S	E	R	I	P
Ex	Ex	Rm	Rm	Ty	Pr	Pr

Health: 100 Karma: 14

If the Growing Man suffers a physical blow or force attack that is of higher rank than his current Strength or Endurance ranks, raise the Growing Man's Strength and Endurance to the rank of the inflicted blow, and adjust Health as well. His size also increases, as if using the Growth power, until he reaches a height rank equal to the rank of the absorbed blow. He suffers no damage from an attack he absorbs, or from one with a rank less than or equal to his current Endurance rank. The Growing Man can be slammed, but not stunned by an attack he absorbs. He has a maximum limit of Monstrous in Strength, Endurance, and Growth.

Side Arms (not used by all Kangs): Kang carries on his person 1-4 concealed weapons, usable even if his armor is disabled. These weapons have an intensity and range equal to his gauntlet blasters.

TALENTS: Kang has Repair/Tinkering and Engineering skills.

CONTACTS: Kang needs no allies. Some Kangs rule large empires in their home time-eras.

BACKGROUND: Rama-Tut, fleeing from the 30th Century B.C. after a defeat by the Fantastic Four, reached the 20th Century A.D. and met Doctor Doom. Rama-Tut continued his journey to the war-torn 41st Century A.D., built a suit of armor inspired by Doom's, and assumed the identity of Kang the Conqueror. His conquering efforts throughout the time stream created many divergent doubles. In most of those realities, Kang's principal opponents were the Mighty Avengers.

A group of three Kangs recently formed a conspiracy that drew all other divergent Kangs to True Limbo and killed them, thus preventing further time-meddling. Once the task was complete the most capable Kang-conspirator killed his two "time-brothers," fought the Avengers, and was defeated and driven insane by Immortus himself, who revealed that he had been manipulating the conspiracy. At present, there is only one surviving Kang, still insane and stranded in the realm of Immortus:

F	A	S	E	R	I	P
Ty	Gd	Rm	In	Am	Rm	In

Health: 66 Karma: 120

KORVAC

Michael Korvac (dead)

F	Am	(50)	Health: 3,250
A	Un	(100)	
S	Un	(100)	Karma: 3,095
E	C13000		
R	In	(75)	Resources: CI 1000
I	Ex	(20)	
P	CI 3000		Popularity: 0

KNOWN POWERS:

Mental Powers: Korvac could use any mental power listed in the Players' Book at Class 1000 level.

Energy Manipulation: Korvac could control all forms of energy at Shift Y rank. His power stunts include:

- Projecting Force or Energy bolts (capable of slaying true immortals)
- Creating a personal forcefield

Cosmic Awareness: Korvac had this power at Class 1000 rank.

Healing: Korvac had this power at Class 1000 rank, capable of resurrecting the dead.

Invulnerabilities: Korvac was Invulnerable to heat cold, radiation, toxins, and disease

Alter-Ego: Korvac's human body was a disguise to prevent foes from suspecting him:

F	A	S	E	R	I	P
Ex	Rm	Ex	Rm	Mn	Ex	CI 3000

TALENTS: Korvac was highly skilled with Computers and Electronics.

CONTACTS: Korvac was in love with Carina, the daughter of the Collector.

BACKGROUND: Korvac was born in the 31st Century of an alternate Earth. He became a cyborg, with a Powerful desk-sized computer replacing his lower body. His plan to conquer his universe was foiled by Thor and the Guardians of the Galaxy, the defenders of that era. He journeyed to the 20th Century of mainline Earth and acquired godlike powers when he tapped the computers of Galactus. He fell in love with Carina, who had been sent to spy on him. Korvac planned to establish a benevolent universal dictatorship, but he was discovered before he could do so. Attacked by the Avengers and the Guardians, Korvac killed almost all of them, then committed suicide when Carina hesitated to support him. Before dying, Korvac resurrected the Avengers and Guardians he had killed.



LAVA MEN

F	Gd	(10)	Health: 70
A	Gd	(10)	
S	Ex	(20)	Karma: 16
E	Rm	(30)	
R	Pr	(4)	Resources: Pr
I	Ty	(6)	
P	Ty	(6)	Popularity: -5

KNOWN POWERS:

Invulnerability: Lava Men are Invulnerable to heat and fire.

Heat Generation: The Lava Men generate tremendous amounts of heat internally. Their normal skin temperature is of Incredible intensity. A Lava Man can increase the temperature by one rank each round, to a maximum of Unearthly. Temperatures above Incredible can be sustained for 5 rounds; each round thereafter requires a successful Endurance FEAT roll. Skin temperatures cannot be reduced below Incredible.

Body Armor: The rock-like skin of a Lava Man provides Excellent protection against physical attacks. In addition, any weapon with a material strength rank equal to or lower than a Lava Man's skin temperature melts when it strikes him, causing no damage.

Mystical Ability: This power, of Incredible rank, is wielded by the shamans of the race. The shamans can perform the following power stunts:

- Conjuring a pile of volcanic ash
- Transmuting metal into volcanic ash
- Growth as the power
- Earth Control as the power, but limited to molten lava

Weapons: Lava Men sometimes use granite clubs (Amazing material), or throw handfuls of molten rock (Incredible intensity heat). For serious warfare, they use granite battering rams (treat as Charging attack), and catapults loaded with lava (Incredible heat, range 10 area).

BACKGROUND: A demon granted the subterranean Lava Man race its current form and powers. One tribe, led by the shaman Jinku, has unsuccessfully attempted to conquer the surface world. Another nomadic tribe settled in caverns beneath Project Pegasus and attacked when the Project unintentionally drilled into the cavern. The Avengers and Spider-Man halted the attack and cleared up the misunderstanding.

LIVING LASER

Arthur Parks

F	Gd	(10)	Health: 40
A	Gd	(10)	
S	N/A	(0)	Karma: 16
E	Ex	(20)	
R	Pr	(4)	Resources: N/A
I	Ty	(6)	
P	Ty	(6)	Popularity: 10

KNOWN POWERS:

Body Transformation - Light: The Living Laser's entire body has been transformed into a sentient quantity of light. The Living Laser's transformation is irreversible at the present time. His established power stunts include:

- Holographic illusion of his human form
- Flight at Class 3000 speed (50 areas per round)
- Laser beam of Monstrous intensity (Energy attack)
- Light of Monstrous intensity

In his current form, the Living Laser is invulnerable to physical attacks and most energy attacks, but can be harmed by magical or mental attacks, and can be harmed by laser or light-based attacks or by the Darkforce.

Human Form: As a human being, the Living Laser had the following stats:

F	A	S	E	R	I	P
Gd	Gd	Gd	Ex	Ex	Ty	Ty

The Living Laser's Reason deteriorated after his transformation, but may return.

TALENTS: Parks was trained in Laser Technology and had Electronics and Repair/Tinkering skill.

CONTACTS: In the past, the Living Laser has worked for the Mandarin, Batroc, the Grim Reaper, Count Nefaria, and the government of East Germany.

BACKGROUND: Parks started his career using laser projectors on his wrists. An infatuation with the Wasp led him to fight the Avengers on several occasions. Parks later implanted light-gathering diodes within his body so he could generate lasers naturally, but when Count Nefaria augmented his power, Parks found that the diodes could not be turned off. The East Germans built a machine that siphoned off the excess energy and used it to power satellite weapons. Iron Man destroyed the siphon and Parks' body exploded.

MAD THINKER

Real Name Unrevealed

F	Ty	(6)	Health: 24
A	Ty	(6)	
S	Ty	(6)	Karma: 62
E	Ty	(6)	
R	Am	(50)	Resources: Rm
I	Ty	(6)	
P	Ty	(6)	Popularity: -20

KNOWN POWERS:

Computer Brain: The Mad Thinker works out the probabilities involved in his schemes in minute detail. He can predict the actions of normal humans and non-intelligent robots with Shift Z Precognition ability. Against super-human heroes this power falls to Poor rank.

Weapons: The Mad Thinker carries a coin-sized "hypno-lens" that functions as the Mesmerism and Hypnosis talent at Amazing rank. He sometimes carries a concussion pistol.

The Awesome Android: This 15-foot-tall creature combines a robotic brain with an android's body:

F	A	S	E	R	I	P
Ex	Ty	In	Ex	Pr	Pr	Pr

- Power Imitation, Special - Upon touch, the Awesome Android can copy certain powers of his opponent. It copies these with Amazing ability; the duplication lasts for 5 rounds. Powers that can be copied are those in the Body Control and Body Alterations Offensive/Defensive categories. The Awesome Android cannot duplicate any of the following: Alter Ego, Growth, Shrinking, Extra Body Parts, Immortality.
- Breath Weapon - The Awesome Android can exhale with such force as to create Remarkable intensity winds.

TALENTS: The Mad Thinker is a genius in the field of Mathematics, Computers, Electronics, and Engineering. All his inventions are combinations of other peoples' work - he is incapable of original ideas.

CONTACTS: In the past, the Mad Thinker has allied himself with the Puppet Master, Egghead, and Klaw.

BACKGROUND: A long-time enemy of the Fantastic Four, the Mad Thinker has also fought the Avengers, and once tried to brainwash the Vision into assassinating the FF.

MAELSTROM

Real Name Unrevealed

F	Gd	(10)	Health: 100
A	Ex	(20)	
S	Rm	(30)	Karma: 90
E	In	(40)	
R	In	(40)	Resources: Rm
I	Gd	(10)	
P	In	(40)	Popularity: -5

KNOWN POWERS:

Absorption Power-Kinetic Energy: Maelstrom can absorb physical blows and convert their kinetic energy into increased Health and Strength. When Maelstrom is struck, the rank number of the blow is added to his Health. Further, if the blow's rank is higher than Maelstrom's current Strength rank, his Strength increases by +1 CS. (For example, an Amazing blow would increase Maelstrom's Health to 140 and his Strength to Incredible.) The effects of an absorbed blow last for 10 rounds. When not augmented by his siphon devices, the upper limits of his Strength and Health are Monstrous and 400. He has developed one established power stunt - Kinetic Lash - in which he can divert absorbed Health into a Force attack with a range of 3 areas.

Maelstrom can be slammed or stunned only by blows with a rank higher than Maelstrom's power rank.

Health-Drain Aura: Maelstrom drains Health ("bio-kinetic energy") from opponents in the same area. He does so at Good rank. Victims can avoid losing Health by making a successful Endurance FEAT roll versus Good intensity.

Power Siphons: Maelstrom built two devices that enabled him to exceed normal limits on his Absorption powers. The first siphon converted the mental energies of the Uni-Mind (a group organism composed of all Eternals) into an absorbable form. The second device drained kinetic energy from the Earth itself, slowing the planet's rotation. Either of these schemes, had they not been stopped, would have given Maelstrom power in the Class 1000 - Class 5000 range.

Clones: Maelstrom can create clones of himself and his minions. When any of them are killed, the technology in Maelstrom's lair draws the life-force to the new body. The transfer has an intraplanetary range (4000 + miles). This gives Maelstrom practical immortality, subject only to the number of clones he has the chance to create.

Minions: Maelstrom employs three superhuman minions, kept in line through intimidation and the promise of clonal immortality. Their true origins are currently unknown:

Gronk

F	A	S	E	R	I	P
Rm	Gd	In	Mn	Pr	Ty	Pr

KNOWN POWERS:

Body Armor (Remarkable)
Adhesion. Gronk can make people or objects touching him stick to him with Monstrous adhesion.

Helio

F	A	S	E	R	I	P
Ty	Gd	Rm	Ty	Ty	Ty	

KNOWN POWERS:

Flight (Shift X)
Create Tornadoes (Amazing)

Phobius

F	A	S	E	R	I	P
Pr	Ty	Pr	Gd	Ty	Gd	Ex

KNOWN POWERS:

Emotion Control-Fear. Phobius is limited to this effect only. His power is of Incredible intensity.

TALENTS: Maelstrom is a master of Genetics, Biochemistry, Physics, and Engineering. He also has Repair/Tinkering talent.

CONTACTS: Maelstrom usually works without allies, but has shared scientific knowledge with Arnim Zola, the Enclave, and Magneto, along others. For a time, Deathurge was an associate, but was dismissed when Maelstrom realized that Deathurge's purpose was to slay him at every opportunity.

BACKGROUND: Maelstrom's father was an Inhuman scientist exiled from Attilan for experimenting with the forbidden science of cloning. In exile, he found the Deviant woman who became Maelstrom's mother; Maelstrom is the first known Inhuman/Deviant cross-breed. Ostracized by the Deviants, Maelstrom and his father encountered Arnim Zola, then set up a base in the underwater ruins of Attilan, after the city was moved to the Moon. Maelstrom's first scheme was an attack on Attilan using Anti-Terrigen gas. In the course of this scheme, Maelstrom was killed by Deathurge, but was resurrected in clonal form. He suffered the same fate after his attack on the Uni-Mind. The atoms of his body were scattered after his attempt to siphon the Earth's rotation.



MAN-APE

M'Baku

F	In	(40)	Health: 130
A	Ex	(20)	
S	In	(40)	Karma: 46
E	Rm	(30)	
R	Ty	(6)	Resources: Gd
I	Rm	(30)	
P	Gd	(10)	Popularity: -5

KNOWN POWERS:

Tracking: The Man-Ape can track prey with Remarkable ability.

TALENTS: In combat, the Man-Ape uses Martial Arts A and C, as well as Acrobatics. He also has Thrown Weapons and Sharp Weapons skills.

CONTACTS: The Man-Ape was a frequent ally of the Grim Reaper in his various battles with the Avengers, but the Man-Ape became disgusted by the Reaper's racism and deserted the Reaper in the midst of battle. In Wakanda, he is the leader of the banned White Gorilla cult.

BACKGROUND: M'Baku was a formidable warrior in his native land and believed that the Wakandan policy of technological development was wrong. M'Baku believed (as did others) that Wakanda should return to its traditional ways and isolate itself from the outside world. While the Black Panther was in the United States, M'Baku hunted and killed a rare white gorilla and performed a mystic ceremony that gave him superhuman strength. He then revived the White Gorilla cult, an act of treason, and made several unsuccessful attempts to kill the Black Panther. He has also fought both teams of Avengers. The Man-Ape has been permanently exiled from his homeland and will be executed if he returns.

MASTER PANDEMONIUM

Martin Preston

F	Gd	(10)	Health: 70
A	Gd	(10)	
S	Rm	(30)	Karma: 46
E	Ex	(20)	
R	Ty	(6)	Resources: Rm
I	Gd	(10)	
P	Rm	(30)	Popularity: 0

KNOWN POWERS:

Demonic Limbs: At will, Master Pandemonium can detach his arms and legs, which are actually demons. Pandemonium has Unearthly control over the demons:

F	A	S	E	R	I	P
Rm	Gd	Rm	Gd	Ty	Gd	Ty

Body Armor (Good)

Flight (Excellent)

Claws (Excellent)

Demon-Horde: Master Pandemonium can summon 1-10 demons per round through the star-shaped hole in his chest. They have the same stats and powers as the limb-demons.

Invulnerability: Master Pandemonium has Class 1000 resistance to Fire.

Eldritch Attacks: Master Pandemonium can exhale a flame-blast and shoot Force bolts from his hands; both are of Monstrous intensity and range.

Power Absorption-Demonic: Master Pandemonium has the same Body Armor and Flight powers as his demons.

Familiar-Azmodeus: This demonic bird has the same statistics and powers of the limb-demons, and has Amazing Magic Detection powers and Excellent Growth powers as well.

Amulet of Azmodeus: This device allows Master Pandemonium to teleport with Amazing ability; it has covered several miles in one trip. In the hands of an enemy, it prevents Pandemonium from releasing demons.

TALENTS: Master Pandemonium has Acting and Business/Finance talents, and knowledge of Occult Lore.

CONTACTS: None known.

BACKGROUND: The demon Mephisto seized actor Preston's soul and made his body an abode for demons. He seeks "The Five," demons whose importance has not been revealed.

MELTER

Bruno Horgan (dead)

F	Gd	(10)	Health: 32
A	Ty	(6)	
S	Ty	(6)	Karma: 32
E	Gd	(10)	
R	Ex	(20)	Resources: Ex
I	Ty	(6)	
P	Ty	(6)	Popularity: -20

KNOWN POWERS:

The Melter's powers derived from his melting-ray weapon, which severed the bonds binding atoms into molecules.

Melting Ray, Mark I: This device used magnetic rays to break down iron and steel. The ray had Excellent intensity and range, and was mounted in the Melter's chest-harness.

Melting Ray, Mark II: This version used different principles, and was far more powerful. Microwave emissions set for four specific frequencies allowed the device to "melt" metal, stone, wood, and human flesh with Remarkable intensity and range. Changing the frequency setting on the weapon took 1 round. The ray was incorporated into a pistol designed by Tony Stark, whom the Melter kidnapped.

Melting Ray, Mark III: This version was identical in performance to the Mark II, however, the weapon was built into the Melter's belt.

Melting Ray, Mark IV: If the Melter was to be believed, this version had Monstrous intensity and range and was capable of destroying all of Avengers Mansion, along with its occupants. Thanks to the villain-killer Scourge, this version was never tested; Scourge destroyed at least one copy of the weapon, and probably destroyed them all.

TALENTS: Horgan had Engineering, Repair/Tinkering, and Business/Finance talents.

CONTACTS: The Melter was a member of the first and second Masters of Evil.

BACKGROUND: Horgan was a weapons designer and industrialist who lost important government contracts through shady practices; many of these contracts were awarded to Tony Stark. Horgan first used his melting ray to try to get revenge on Stark. The Melter fought both the Avengers and Iron Man, and finally fell victim to the mysterious and deadly Scourge.

MISTER HYDE

Calvin Zabo

F	Rm	(30)	Health:	140
A	Gd	(10)		
S	Am	(50)	Karma:	115
E	Am	(50)		
R	Rm	(30)	Resources:	Gd
I	Gd	(10)		
P	Mn	(75)	Popularity:	-30

KNOWN POWERS:

Body Armor: Hyde's transformed flesh provides Incredible protection from physical damage and Excellent protection from energy attacks.

Resistances: Hyde has Excellent resistance to fire, heat, cold, corrosives, and toxins.

Alter-Ego: (not currently in use) By drinking different mixtures of his transformation potion, he could be Hyde or Zabo at will. Zabo's statistics are:

F	A	S	E	R	I	P
Ex	Gd	Ty	Rm	Rm	Ty	Gd

He usually carried vials of the potion with him at all times, and often changed from Hyde to Zabo to elude pursuit after his crimes.

TALENTS: Zabo was trained in Chemistry and Biochemistry; Hyde also has this knowledge.

CONTACTS: Hyde is currently a member of the fourth Masters of Evil.

BACKGROUND: Scientist Calvin Zabo worked for years to find a formula that could duplicate the events in Robert Louis Stevenson's story *Dr. Jekyll and Mr. Hyde*. Zabo stole from his various employers to finance his research. Finally he succeeded, transforming himself into a superhuman incarnation of bestial rage. His enemies include Thor, Daredevil, Spider-Man, and especially the Cobra, a former partner who betrayed Hyde and is now terrified of him. Recently, he found that the Zabo-transformation potion no longer worked. After reformulating the potion, Hyde found that it would transform him to Zabo permanently. Hyde was about to drink it when Daredevil, who was pursuing him after his latest crime, attacked. Realizing how numerous his enemies were, Hyde decided to keep his monstrous form forever. Although he is highly intelligent, Hyde has difficulty remaining calm even when alone. In battle, his ferocity make him nearly unstoppable, and he holds grudges for a long, long time.

MODRED THE MYSTIC

Modred

F	Ty	(6)	Health:	82
A	Ex	(20)		
S	Ty	(6)	Karma:	101
E	Am	(50)		
R	Ty	(6)	Resources:	Ex
I	Ex	(20)		
P	Mn	(75)	Popularity:	-20

KNOWN POWERS:

Magical Ability: Modred's magic can produce the following effects:

- **Magic Detection (U)** - As Power, Monstrous rank and range
- **Matter Control, Earth, Air, Fire, Water, Weather (U)** - As Powers, with Amazing rank and range
- **Eldritch Beams/Bolt (U)** - As Energy or Force Missile, of Incredible power and range
- **Shield, Individual (U)** - As personal Force Field, of Incredible rank
- **Body Alteration, Strength Increase (U)** - +3 CS to Strength
- **Flight (U)** - As Power, Incredible speed

Demonic Entreaty: Modred could gain increased power by invoking the Darkhold; this provides a +1 CS to the powers listed above, and also gave him access to most Personal or Dimensional spells at Remarkable rank; however, see *Contacts*.

TALENTS: Modred has great knowledge of Occult Lore; his Reason is + 1 CS in this.

CONTACTS: Modred's only friendly contact was the demon Chthon, using the Darkhold. This contact is broken until the book is released from Doctor Strange's spell, which prevents the book's use.

BACKGROUND: The Darkhold was written eons ago by the elder demon Chthon, when the gods forced the demons to flee the Earth; it was intended to be the means of Chthon's eventual return. In the Sixth Century A.D., Modred tried to master the book's magic for good purposes; instead, he was corrupted and fell into a coma that lasted 14 centuries. In the 20th Century, Modred recovered the Darkhold and set in motion Chthon's return, using the Scarlet Witch as the demon's host-body. The Avengers foiled the plot and seized the Darkhold; the book was later in Doctor Strange's possession. Modred returned to his native England and fought both Captain Britain and Captain America, but was defeated. Captain Britain's patron, the sorcerer Merlin, removed Modred to another dimension.



MOONSTONE

Dr. Karla Sofen

F	Gd	(10)	Health: 100
A	Ex	(20)	
S	In	(40)	Karma: 40
E	Rm	(30)	
R	Gd	(10)	Resources: Gd
I	Gd	(10)	
P	Ex	(20)	Popularity: -15

KNOWN POWERS:

Light Manipulation: Moonstone has this power at Amazing rank, and can emit a blinding flash of Amazing intensity that effects everyone within one area, except herself. She can also emit a laser beam of Amazing intensity and range (Energy damage).

Phasing: Moonstone can pass through solid objects with Amazing ability. The amount of time she can remain out of phase is the amount of time she can hold her breath. While out of phase, she is unaffected by physical and most energy attacks.

Flight: By manipulating gravitons, Moonstone can fly at Poor speed (4 areas per round).

TALENTS: Moonstone is trained in both Psychiatry and Medicine. She has often used drugs to manipulate people for her own ends.

CONTACTS: Moonstone has been an agent of the Corporation, a defunct criminal conspiracy. She was a partner of Blackout, and has served in the third and fourth Masters of Evil (Egghead's and Baron Helmut Zemo's, respectively).

BACKGROUND: The source of Moonstone's power is a rock taken from the Blue Area of the Moon, the home of the Watcher; it is believed that the rock possesses a fraction of his power. The original Moonstone was a criminal named Byron Becton. Dr. Sofen used hallucinogenic gas to make Becton give up the stone, which she then absorbed into her own body. She has fought various super heroes and was imprisoned at Project Pegasus for a time. After her most recent defeat by the Avengers, she was freed by the Absorbing Man and Titania, who were disguised as police.

NEBULA

Real Name Unrevealed

F	Rm	(30)	Health: 130
A	Rm	(30)	
S	Ex	(20)	Karma: 100
E	Am	(50)	
R	Rm	(30)	Resources: Rm
I	Rm	(30)	
P	In	(40)	Popularity: 0

KNOWN POWERS:

Wrist-Blasters: Nebula wears a pair of bracelets that fire Energy bolts of Excellent rank to a range of 10 areas.

Fleet: When fighting in the Skrull Civil War, Nebula commanded a space-fleet of Monstrous numbers and Resources. The fleet was a motley collection, but the Space Ship statistics from the Advanced Set can be used for all of them. Each has 4-10 weapons that inflict Amazing damage, usually a mixture of laser cannons, plasma beam cannons, and high-tech missiles.

Flagship-Sanctuary II: This gargantuan space-dreadnought was originally built by Thanos, and abandoned after his death. The ship was captured and hijacked by Nebula's minions. Sanctuary II was the size of a small planet, and its firepower was equal to that of the rest of the fleet combined. Sanctuary II's main weapons were of Unearthly rank, and its minor weapons were of Amazing rank; it had hundreds of the former and thousands of the latter. Sanctuary II's hanger deck held over 100 smaller space ships for close-in defense. The ship was protected by a force-field of Unearthly rank, which drew its power from the same source as the main weapons; these could not be used while the forcefield was operating. The crew of Sanctuary II numbered over 10,000.

Control	Speed	Body	Protection
Mn	C13000	Mn	Mn

Sanctuary II was captured by a Skrull boarding party led by the Avengers. To prevent the ship from ever again threatening the universe, Starfox set the ship's major systems to overload. Sanctuary II self-destructed in a massive explosion.

Minions: These four were Nebula's most important lieutenants. Gunthar and Kehl are at large, and Levan and Skunge were captured by the Skrulls.

Gunthar of Rigel

F	A	S	E	R	I	P
Gd	Gd	Gd	Gd	Ex	Ex	In

KNOWN POWERS:

Mind Thrust: This mental power can be used as the Mind Control power at Remarkable rank or as an Incredible Energy attack, range 2 areas.

Density Manipulation, Self: This power is of Incredible rank, but is limited to increased density only.

Kehl of Tauran

F	A	S	E	R	I	P
Rm	Gd	Mn	Un	Pr	Fb	Fb

KNOWN POWERS:

Body Armor (Remarkable)
Life Support (Good)

Levan of Sark

F	A	S	E	R	I	P
Ex	Ex	Gd	Rm	Ex	Ex	Ex

KNOWN POWERS:

None. Levan carries a laser pistol.

Skunge the Laxidazian Troll

F	A	S	E	R	I	P
Gd	Gd	Ty	Ex	Gd	Ty	Pr

KNOWN POWERS:

None. Skunge carries a laser pistol.

TALENTS: Nebula has Military and Leadership talents.

CONTACTS: Nebula's current contacts are unrevealed.

BACKGROUND: Nebula claims to be the grand-daughter of Thanos, and commanded the same kind of space-faring scum he did. Using a Skrull governor as a figurehead lackey, she tried to conquer the fragmented Skrull Empire. When Sanctuary II was hijacked, the Avenger Captain Marvel was on board. She summoned the Avengers, who joined forces with a Skrull fleet to defeat Nebula. She escaped when the Beyonder mistakenly teleported her, Gunthar, and Kehl to an unrevealed galaxy. Her great-uncle Starfox and Firelord, a former herald of Galactus, are pursuing her. Nebula is cruel, ambitious, and rules her lackeys with an iron fist.

NEKRA

Nekra Sinclair

F	Rm	(30)	Health: 110
A	In	(40)	
S	Gd	(10)	Karma: 56
E	Rm	(30)	
R	Ty	(6)	Resources: Pr
1	Gd	(10)	
P	In	(40)	Popularity: -5

KNOWN POWERS:

Increased Strength: When Nekra feels violent hatred, her Strength increases to Incredible. However, this does not increase her Health. The increased Strength lasts for one hour. Once it declines, she cannot augment her Strength again for 8 hours. The circumstances under which she would feel this Strength-enhancing hatred are what one would expect-combat, ridicule, being betrayed, etc.; in these cases the increase is automatic-but she can also trigger the increase by making a successful Psyche FEAT roll.

Body Armor: When Nekra is in the Strength-enhanced condition described above, she also gains Amazing body armor. This power works under the same conditions and limitations as the Increased Strength power.

Necromancy: Nekra learned the art of zombie-creation from the Black Talon (described elsewhere in this book). Her ability to create zombies is identical to his. She has developed a power stunt in which she can create a life-like zombie that has the same stats and powers that he had in life (rather than the usual zombie FASERIP). Such a zombie has the special powers of a usual zombie, but is free-willed; it will believe it is alive.

Tracking: Nekra has Excellent tracking skills.

LIMITATION: Nekra is vulnerable to scent-based attacks, such as tear gas or the Pheromones power. She is -2 CS on any FEAT roll to resist the effect.

TALENTS: Nekra uses Martial Arts A, B, and E, and has studied Occult Lore.

CONTACTS: Nekra was an associate of the Black Talon, and the lover of the Grim Reaper.

BACKGROUND: Nekra is a mutant and her past is more fully described in MA1 *Children of the Atom*. She found the Reaper's obsessive hatreds attractive, and she made him a zombie after his death.

RADIOACTIVE MAN

Dr. Chen Lu

F	Gd	(10)	Health: 70
A	Gd	(10)	
S	Rm	(30)	Karma: 32
E	Ex	(20)	
R	Ex	(20)	Resources: Gd
I	Ty	(6)	
P	Ty	(6)	Popularity: -10

KNOWN POWERS:

Nuclear Energy Manipulation: Dr. Lu's body is a living nuclear reactor. He can utilize his body's energy for a number of effects:

- Radiation bolts (Energy attack) of Amazing power and range
- Heat bolts (Energy attack) of Amazing power and range
- Light-flash of Amazing intensity to temporarily blind opponents, range 1 area
- Controlled light-effect that acts as the Mesmerism and Hypnosis talent at Remarkable rank, range 1 area

Invulnerability: The Radioactive Man has Class 1000 resistance to nuclear radiation.

Force-Field: The field yields Monstrous protection against physical and energy attacks. If he makes a successful power FEAT roll, the Radioactive Man can capture projectiles hurled at him and redirect them to other targets. He has done this with Thor's hammer on numerous occasions.

LIMITATION: The Radioactive Man's body constantly emits Feeble amounts of radiation that affect those in his area. This radiation is absorbed by a special harness in his costume, making it safe to be in his presence.

TALENTS: Dr. Lu is a leading expert on Radiation and Nuclear Physics.

CONTACTS: The Radioactive Man was a member of the first three Masters of Evil. He has also worked with the Mandarin, and was a member of the Titanic Three, a now-defunct team of heroes fighting crime in Communist Asia (the other members were the Crimson Dynamo and the Titanium Man).

BACKGROUND: After Thor stopped a Chinese attack on India, Dr. Lu volunteered to become the Chinese Government's superhuman weapon against Thor. He has fought Thor and the Avengers several times. The Radioactive Man has left the service of the state, and his current activities are unknown.



RAMA-TUT

Real Name Unrevealed

F	Ty	(6)	Health: 46
A	Gd	(10)	
S	Gd	(10)	Karma: Varies
E	Ex	(20)	
R	In/Am*		Resources: Mn
I	Ty/Rm*		
P	Gd/In*		Popularity: Varies*

* Rama-Tut's time-travelling has resulted in a multitude of divergent doubles who are not identical in abilities. When using him as a villain, choose Reason, Intuition, and Psyche ranks that will make that particular Rama-Tut a challenge for his opponents.

KNOWN POWERS:

Time-Ship: The time-ship used by Rama-Tut is a slightly earlier version of Kang's ship. Rama-Tut's time-ship can travel from era to era, and is also capable of interplanetary space travel. The time-ship is camouflaged as an Egyptian sphinx.

Control	Speed	Body	Protection
In	Sh Y	In	In

Mind Control: Rama-Tut's principal weapon was his "ultra-diode" gun, a Mind Control ray of Remarkable Intensity.

Robot Warriors:

F	A	S	E	R	I	P
Ex	Gd	Gd	Ex	Pr	Pr	Pr

These robots have Good body armor and carry force or energy weapons of Excellent intensity.

LIMITATION: Rama-Tut was blind when he arrived in Egypt, due to an accident aboard the time-ship. The Egyptians restored his sight through mystical means.

TALENTS: Rama-Tut has Repair/Tinkering and Engineering skill.

CONTACTS: Rama-Tut ruled the most advanced ancient civilization of the era.

BACKGROUND: Rama-Tut is a descendant of Nathaniel Richards, father of Reed Richards. Seeking adventure, Rama-Tut discovered his ancestor's time machine and used it to build an empire in ancient Egypt. He was overthrown by the Fantastic Four, and he fled to the 20th Century A.D., where he met Doctor Doom. This event led Rama-Tut to assume new armored identities as Kang and the Scarlet Centurion.

RONAN THE ACCUSER

Ronan

F	Ex	(20)	Health: 110
A	Gd	(10)	
S	Am	(50)	Karma: 50
E	Rm	(30)	
R	Ex	(20)	Resources: Am
I	Gd	(10)	
P	Ex	(20)	Popularity: -15

KNOWN POWERS:

Most of Ronan's powers derive from his armor and the Universal Weapon. Without them, his statistics are:

F	A	S	E	R	I	P
Ex	Gd	In	Ex	Ex	Gd	Ex

Body Armor: Ronan's armor provides Remarkable protection against physical and energy attacks, but not against mental attacks.

Invisibility: The armor provides Invisibility of Excellent rank.

Universal Weapon: This is the personal weapon of the Supreme Public Accuser. It's powers are numerous, all of which operate at Monstrous rank:

- Energy or Force bolt - Range 20 areas
- Force-Field - Protects against physical and energy attacks, but not mental attacks.
- Energy Absorption - Can absorb most types of energy. Up to 200 points can be stored and then channeled through the Universal Weapon as an attack.
- Gravity Control - Range 20 areas
- Teleportation - This power carries the user through hyperspace, making interstellar journeys possible.
- Disintegration - Affects inanimate objects only, Monstrous range
- Matter Transmutation - Affects inanimate objects only, Monstrous range

TALENTS: Ronan is a Weapon Specialist with the Universal Weapon (+2 CS). He also has Law, Law Enforcement, Military, and Leadership talents.

CONTACTS: As Supreme Public Accuser, Ronan is the third-highest ranking official in the Kree Government.

BACKGROUND: Ronan usurped control of the Kree Empire shortly before the Kree-Skrull War and led it in that war. The Supreme Intelligence activated the psionic powers of Rick Jones and used him to defeat Ronan and end the war. Ronan has also fought Captain Mar-Vell and the Fantastic Four.

SENTRY

F	Ex	(20)	Health: 215
A	Ex	(20)	
S	Mn	(75)	Karma: 14
E	Un	(100)	
R	Ty	(6)	Resources: N/A
I	Pr	(4)	
P	Pr	(4)	Popularity: 0

There have been three Kree Sentries placed in the Solar System; The description here is for Sentry #459.

KNOWN POWERS:

Body Armor: Sentry #459 had Amazing protection from physical and energy attacks.

Invulnerabilities: Sentry #459 was Invulnerable to emotion attacks, disease, and toxins (it was a robot), as well as to corrosives (it was a tough robot).

Computer Link: Sentry #459 could transmit data and receive instructions across interstellar distances.

Blast-Ray: This weapon, mounted in the robot's chest, fired a Force bolt of Amazing rank, to a range of 10 areas.

TALENTS: None.

CONTACTS: None.

BACKGROUND: The Sentries are robots manufactured by the Kree for military and observation purposes. Sentries have no creative intelligence or imagination and simply follow their pre-programmed instructions. A Sentry never wears out and will last for a millenia unless destroyed. The first Sentry in the Solar System, #213, was set to guard an unmanned base on Uranus. It was destroyed by a band of exiled Eternals. This incident eventually led to the creation of the Inhumans, and Sentry #459 was posted to monitor their development. The Fantastic Four landed on the Sentry's island and were attacked; the FF defeated but did not destroy the robot. Ronan the Accuser used #459 to battle the Avengers in a scheme to reverse human evolution (this is why its description follows Ronan's). Captain Mar-Vell fought the robot several times. Sentry #459 was finally destroyed by Ronan. Sentry #9168 attempted to kill Earth astronauts who landed on the Moon, to retard human space exploration and to keep the Kree's lunar city unknown to Earth. Sentry #9168 was foiled by the Fantastic Four; its current condition is unrevealed.

SCARLET CENTURION

Real Name Unrevealed

F	Ty	(6)	Health: 46
A	Gd	(10)	
S	Gd	(10)	Karma: 60
E	Ex	(20)	
R	In	(40)	Resources: Mn
I	Gd	(10)	
P	Gd	(10)	Popularity: 0

KNOWN POWERS:

Time-Ship: This is the same version used by Rama-Tut. It can travel from era to era, and is also capable of interplanetary space travel.

Control	Speed	Body	Protection
In	Sh Y	In	In

Mind Control: The Scarlet Centurion's principal weapon of conquest was a Mind Control device of Amazing Intensity.

Body Armor: The Scarlet Centurion wears full-body armor that provides Remarkable protection against physical and energy attack.

Resistances: The armor provides Amazing resistance to corrosives, toxins, and disease.

Gauntlets: Each finger of his gauntlets is equipped with a different weapon; all have a range of 5 areas. These include:

- Shock-Blaster - Incredible electrical damage
- Ice-Blaster - Imprisons one target in a block of Excellent strength ice
- Light-Blaster - Incredible intensity light, can temporarily blind opponents
- Sleep Inducer - Causes drowsiness and sleep, Excellent intensity
- Force-Blaster - Incredible Force bolt

TALENTS: The Scarlet Centurion has Repair/Tinkering and Engineering skill.

CONTACTS: The Scarlet Centurion used the Avengers of his divergent Earth (Iron Man, Thor, Wasp, Giant-Man, Hulk) as his pawns for conquest.

BACKGROUND: The Scarlet Centurion is a divergent double of Rama-Tut who decided to conquer the 20th Century (rather than traveling to the 41st Century and becoming Kang). The Scarlet Centurion used mind control to convince the Avengers of the alternate Earth to defeat all other superhuman beings, but his scheme was thwarted by the Avengers of mainline Earth. It is believed that this Scarlet Centurion is not the same one who battled the Squadron Supreme.

SHOCKER

Herman Schultz

F	Ty	(6)	Health: 52
A	Ex	(20)	
S	Ty	(6)	Karma: 18
E	Ex	(20)	
R	Ty	(6)	Resources: Ty
I	Ty	(6)	
P	Ty	(6)	Popularity: -2

KNOWN POWERS:

Body Armor: The Shocker's padded costume provides Good protection against physical attacks and Amazing protection against vibration and sonic attacks.

Vibro-Smashers: Vibro-units are built into the Shocker's gloves. Singly, they allow him to punch with Remarkable Strength. Used together, they can fire a vibro-blast causing Amazing damage (Force attack). The vibro-blast has a range of 3 areas. Smaller vibro-units are installed throughout his costume, which cause Remarkable damage in Grappling combat. They also give him a +3 CS when trying to escape a hold.

TALENTS: The Shocker has Engineering and Repair/Tinkering talent.

CONTACTS: The Shocker was a member of Egghead's Masters of Evil, but he usually works alone.

BACKGROUND: The Shocker built his first set of vibro-smashers as burglary tools, used to open safes. He fought Spider-Man a number of times, and was recruited into Egghead's Masters of Evil. Egghead brainwashed him and set him up to be captured as part of a scheme to entrap Henry Pym. After this unfortunate experience, the Shocker became a free-lance assassin.



SCOURGE

Real Name Unrevealed (dead)

F	Ty	(6)	Health: 52
A	Ex	(20)	
S	Ty	(6)	Karma: 46
E	Ex	(20)	
R	Ty	(6)	Resources: Ex
I	Rm	(30)	
P	Gd	(10)	Popularity: -5

KNOWN POWERS:

Scourge's Gun: This is a customized .50 caliber submachine gun. The gun fires an armor-piercing explosive bullet that reduces the target's body armor (or vehicle protection) by -2 CS and causes Excellent damage. The gun holds 20 rounds of ammo and can fire a 5-shot burst that causes Remarkable damage. Scourge's gun has a range of 5 areas and is made of Excellent strength material.

Scourge's Van: This vehicle is both a mobile home and a base of operations. It contains spare weapons, ammo, costumes and disguises, a computerized crime-file with data on prospective victims, and a two-way TV monitor.

Control	Speed	Body	Protection
Ty	Ex	Gd	Gd

CONTACTS: The only one known was a detective named Domino who had an astounding knowledge of the underworld and its secrets.

TALENTS: Scourge was a Weapon Specialist with his unique gun (+2 CS), and had Criminology, Disguise, and Marksman talents as well.

BACKGROUND: Scourge's past is still shrouded in mystery. He claimed to be the brother of the criminal Enforcer, and that he killed the Enforcer to avenge the family's disgrace; at least some details of this story are false. Scourge struck ruthlessly, dispatching his victims with a single shot and the grim motto, "Justice Is Served!" In all, he killed 29 super-villains, starting a panic in the underworld. Scourge was finally captured by Captain America, but an unseen assassin murdered Scourge with the same gun and in the same way that Scourge had killed his victims. It is not certain that the dead man was the only Scourge, and it is possible that he was marked for death by the real Scourge to decoy pursuers. The mysteries remain, and the menace of the Scourge may continue.

SCREAMING MIMI

Mimi Schwartz

F	Ex	(20)	Health: 100
A	Ex	(20)	
S	Rm	(30)	Karma: 18
E	Rm	(30)	
R	Ty	(6)	Resources: Ty
I	Ty	(6)	
P	Ty	(6)	Popularity: -5

KNOWN POWERS:

Sound Generation - Hypersonic Scream: Mimi can utter a hyper-sonic scream that affects all in her area and any other direct-line targets to a range of 4 areas. Mimi has established the following power stunts:

- Incredible sonic (Force attack) damage to all in her area
- Remarkable Stunning attack that affects all in her area or in a direct line to a range of 4 areas in direct line. The scream affects all in the target areas; victims must make an Endurance FEAT roll or lose consciousness for 1-10 rounds.
- Holographic illusions at Excellent rank. These cause Good damage to targets in direct line of sight to a range of 4 areas.

TALENTS: Screaming Mimi has Wrestling talent, acquired in her stint in the Unlimited Class Wrestling Federation.

CONTACTS: Apart from the UCWF, Mimi is a member of the fourth Masters of Evil.

BACKGROUND: Screaming Mimi was originally an ordinary wrestler, but Roxxon Oil Company gave her hypersonic powers in exchange for performing a covert attack on Project Pegasus. The attack failed and Mimi was sent to prison. Upon her release, she went to Power Broker, Inc. to gain additional superhuman power. She fought in the UCWF for a time, but was recruited for the fourth Masters of Evil. In her first mission, she helped Yellowjacket II to escape from jail, but was captured herself by the Wasp, the Black Knight, Captain Marvel, and the Paladin.

SPACE PHANTOM

Real Name Unrevealed

F	Pr	(4)	Health: 26
A	Ty	(6)	
S	Gd	(10)	Karma: 42
E	Ty	(6)	
R	Rm	(30)	Resources: Ex
I	Ty	(6)	
P	Ty	(6)	Popularity: 0

KNOWN POWERS:

Power Imitation: Immortus gave the Space Phantom the ability to transform himself into a duplicate of almost any being, acquiring virtually all that being's powers whether they are natural, artificial, or technological. The imitation enables the Space Phantom to use the established power stunts of his victim. (For example, the Space Phantom has imitated the gamma ray-spawned power of the Hulk and the technological might of Iron Man.) The Space Phantom must be in the same area as the person he chooses to imitate, and the imitation is complete in one round. When the Space Phantom imitates a specific person, that person is banished to True Limbo as long as the Space Phantom decides to retain his form. The Space Phantom can apparently duplicate a form as long as desired.

LIMITATIONS: The Space Phantom cannot imitate true immortality, nor can he duplicate magical powers or magical items. If he attempts to do so, he is banished to Limbo rather than his target. The upper limit on all his imitations is Unearthly rank.

TALENTS: The Space Phantom has Military and Leadership talents. He also has an extensive knowledge of the techniques of time travel.

CONTACTS: The Space Phantom is a servant of Immortus.

BACKGROUND: The Space Phantom's race mastered the science of time travel, using it as a tactic in their civil wars. This eventually caused space to rupture, casting the entire planet into Limbo. Immortus rescued the Space Phantom and gave him superhuman powers (not shared by the remainder of his race). Immortus planned to study the beings the Space Phantom dispatched to Limbo. The Space Phantom reached Earth and unsuccessfully attacked the Avengers, reasoning that his race could eventually conquer Earth if he beat the Avengers. Later, Thor sacrificed his hammer's time traveling powers to rescue the Space Phantom's planet from Limbo. Recently, the Space Phantom encountered the Avengers again and may have been killed by Kang.

THE SQUADRON SINISTER

Doctor Spectrum, Hyperion, Nighthawk, Speed Demon

Doctor Spectrum

Dr. Kinji Obatu, and others

F	Ty	(6)	Health: 32
A	Gd	(10)	
S	Ty	(6)	Karma: 66
E	Gd	(10)	
R	Ex	(20)	Resources: Gd
I	Ty	(6)	
P	In	(40)	Popularity: -5

KNOWN POWERS:

Power Prism: Dr. Spectrum's power prism was an evil sentient crystal with an Amazing Psyche. When the prism came into contact with a potential host, the prism had to make a successful Possession FEAT roll to control the host. The prism had extensive Light Manipulation and Energy Manipulation powers. Dr. Spectrum could only create one effect per round, but could also maintain up to three existing effects by making a successful Psyche FEAT roll. Power stunts include:

- Creating a hologram Dr. Spectrum costume for the host
- Energy or Force blasts of Monstrous intensity and range
- A personal force-field of Amazing rank
- Multi-colored "hypno-rings" of light that act as the Mesmerism talent, at Amazing rank, range 3 areas
- The objects of "solid light." Judge decides which creations are within the prism's power and assign a FEAT intensity; shields, simple weapons, entrapment devices, common geometric shapes, and simple containers are power stunts, and usually of Incredible rank.
- Flight: Dr. Spectrum could fly at Excellent speed (10 areas per round).

LIMITATION: When exposed to ultraviolet light, the host had to make an Endurance FEAT roll or fall unconscious for 1-10 rounds; if he failed, the prism was also dormant.

The tactics used by Dr. Spectrum depend upon the relative Psyches of the prism and the host. Dr. Obatu often ignored its advice; the Wasp was dominated by the gem, and it used its energy powers inventively.

BACKGROUND: The Grandmaster found a prism with powers similar to the one used by the heroic Dr. Spectrum. The FASERIP ranks of the criminal Dr. Spectrum are those of the host; in addition to Obatu, the Wasp, Thor, have been possessed, among others.

Hyperion

alias Zhib-Ran (dead)

F	Mn	(75)	Health: 375
A	Un	(100)	
S	Un	(100)	Karma: 110
E	Un	(100)	
R	Ex	(20)	Resources: Gd
I	Am	(50)	
P	In	(40)	Popularity: -5

KNOWN POWERS:

Body Armor: Hyperion had Unearthly protection against all forms of physical or energy attack.

Invulnerabilities: Hyperion had Class 1000 resistance to heat, cold, radiation, and corrosives.

Flight: Hyperion was able to fly at Shift Y speed (100 areas per round), but usually limited himself to Unearthly speed (40 areas per round).

Atomic Vision: Hyperion could project beams of heat or X-rays from his eyes; the beams were of Monstrous intensity and had a range of 10 areas.

LIMITATION: Hyperion was vulnerable to a radioactive isotope of lead (Pb-210). If any of this isotope were in the same area, Hyperion's flight and vision powers were negated. Weapons made of this isotope negate his body armor; the body armor was still effective against other forms of attack.

TALENTS: Hyperion had no particular talents.

CONTACTS: Hyperion was a member of the Squadron Sinister. He also served as a super-agent for the Roxxon Oil Company and as an ally of the alien villain Nebulon.

BACKGROUND: The Squadron Sinister was organized by the Grandmaster as superhuman champions for his games. The identity and powers of each were modeled after members of Other-Earth's Squadron Supreme. The criminal Dr. Spectrum, Nighthawk, and Whizzer were all Earthmen granted superhuman power, but Hyperion was an artificial being created out of extradimensional matter. The Grandmaster gave Hyperion a set of false memories, causing him to believe that his homeland, a subatomic micro-planet, had been destroyed through Earthly experiments in nuclear fission. The Grandmaster unsuccessfully pitted his Squadron against the Avengers in a contest in which Kang was the Grandmaster's opponent. The Squadron Sinister later fought the Defenders. Hyperion has since died.



Nighthawk (Squadron Sinister)

Kyle Richmond (dead)

F	Ex	(20)	Health: 100
A	Rm	(30)	
S	Rm	(30)	Karma: 18
E	Ex	(20)	
R	Ty	(6)	Resources: Ex
I	Ty	(6)	
P	Ty	(6)	Popularity: 5

KNOWN POWERS:

Flight: Nighthawk wore a pair of jet-powered wings that enabled him to fly at Good speed (8 areas per round). Nighthawk could carry up to 200 pounds in flight. He could shut down the wing-jets and glide at Typical speed; this allowed him to blindside opponents. (The wings were a later development, not used in his first battle with the Avengers.)

Claws: Each of Nighthawk's gauntlet's were equipped with three claws of Remarkable strength material. With these he could inflict Edged damage equal to his current Strength. (Like his wings, the claws were not used in Nighthawk's first battle.)

LIMITATIONS: Nighthawk's power declines when he is in direct sunlight; his Strength declines to Typical rank, and his Endurance is reduced to Good. His Health is not reduced accordingly, but the reduced ranks are used for all FEAT rolls. Later injuries left him paralyzed except at night, when his full mobility and power were available.

TALENTS: Nighthawk uses Martial Arts A and E, as well as Acrobatics. He has developed Aerial Combat skill (+ 1 CS to airborne combat FEATs). He also has Business/Finance talent.

CONTACTS: Nighthawk was a member of the Squadron Sinister, but left the group. He later joined the Defenders.

BACKGROUND: Richmond was born wealthy and was lazy and irresponsible in his youth. The Grandmaster gave Richmond the formula for a potion that gave him his powers. After the Squadron Sinister's first battle with the Avengers, Richmond left. He was reunited with the Squadron in a scheme to melt Earth's ice-caps, but he betrayed the Squadron and helped the Defenders beat them. In this battle, he was stricken by radiation that paralyzed him. Nighthawk joined the Defenders, gaining a new sense of responsibility and self-worth. He died while preventing a misguided patriot's attempt to psionically attack the Soviet Union.

Speed Demon

James Sanders (former alias, The Whizzer)

F	Gd	(10)	Health: 135
A	Mn	(75)	
S	Ex	(20)	Karma: 22
E	Rm	(30)	
R	Gd	(10)	Resources: Gd
I	Ty	(6)	
P	Ty	(6)	Popularity: -5

KNOWN POWERS:

Lightning Speed: Speed Demon's normal maximum running speed is Unearthly rank (10 areas per round/150 MPH). In addition to the normal abilities of this power, Speed Demon has some established power stunts:

- By running in a circle, creating a cyclone of Monstrous intensity that can stun or slam anyone caught in its winds.
- By circling a target at high speed, Speed Demon can land multiple blows in a single round, gaining a +2 CS shift on damage and stunning (but not slamming; treat slam results as stuns)

Protected Vision: Speed Demon wears goggles that protect his eyes from the effects of high speed running; they provide Good protection against all anti-visual attacks.

Chemical Weapons: If he has the chemicals available, Speed Demon can create chemical weapons (such as smoke bombs and tear gas), toxins, and corrosives and have them ready for use in the same round. The intensity of the creation depends upon the available ingredients; he does not normally carry chemicals with him. If creating chemical weapons, he can make no other attack that round.

TALENTS: Speed Demon is trained in Chemistry.

CONTACTS: As the Whizzer, Sanders was a member of the Squadron Sinister. Currently, he is a member of the Sinister Syndicate.

BACKGROUND: The Grandmaster gave Sanders the formula for a pill that granted him superhuman powers. After his defeat, he remained in hiding until Nebulon recruited the Squadron. Nighthawk and the Defenders defeated the Squadron Sinister, and after the deaths of his partners, Sanders joined the Beetle's Sinister Syndicate. He changed his alias because the inactive hero Robert Frank, the original Whizzer, returned to active duty. Sanders continues to call himself Speed Demon despite Frank's recent death.

STANKOWICZ, FABIAN

F	Pr	(4)	Health: 20
A	Ty	(6)	
S	Pr	(4)	Karma: 18
E	Ty	(6)	
R	Gd	(10)	Resources: Rm(30)
I	Pr	(4)	
P	Pr	(4)	Popularity: 0

KNOWN POWERS:

Battlesuits: Stankowicz built two battlesuits that raised his abilities to the levels listed below, and had the following powers:

F	A	S	E	R	I	P
Gd	Ty	Rm	Ex	Gd	Pr	Pr

Health: 66 Karma: 18

Body Armor: Remarkable protection versus physical attacks; Good protection vs. energy attacks.

War Machine: Stankowicz used this machine to attack the Wasp and several prospective female Avengers:

Control	Speed	Body	Protection
Gd	Ty	In	In

Servo-Claws: Can strike for Incredible blunt damage or grapple with Incredible strength. The claws are made of Remarkable material.

Traps: These were used to attack the Avengers on national television. The assortment included force-blasters disguised as cameras, a gravity-powered roller, homing missiles, and a personal force-field that protected Stankowicz from the Avengers, but not from the talk-show host who clobbered Stankowicz with a gigantic doorknob. All Stankowicz' devices are of Remarkable intensity or material strength.

TALENTS: Stankowicz has Engineering and Electronics talent.

BACKGROUND: Winning the state lottery allowed Stankowicz to realize his ambition: to be a bombastic, glory-seeking, trivial nuisance. The self-proclaimed Mechano Marauder has fought the Avengers three times; on the most recent occasion, the battlefield was the set of a nationally popular television talk show. Each time, the Avengers defeated Stankowicz with humiliating ease, but he does not learn from painful experience and keeps coming back for more (as in the adventure included in this book).

SUPER SKRULL

Real Name Unrevealed

F	Rm	(30)	Health: 150
A	Ex	(20)	
S	Am	(50)	Karma: 22
E	Am	(50)	
R	Ty	(6)	Resources: Fb
I	Ty	(6)	
P	Gd	(10)	Popularity: -20

KNOWN POWERS:

Body Armor: The Super-Skrull has Remarkable protection from physical damage and Good protection from energy attacks.

Elongation: The Super-Skrull has Unearthly Elongation powers, and can stretch up to 100 yards (3 areas).

Invisibility: The Super-Skrull can make himself invisible with Excellent ability.

Force-Field: The Super-Skrull's force field is of Amazing strength in a single area and is -1 CS in strength for each additional area it covers.

Fire Generation and Control: The Super-Skrull can generate fire of Monstrous intensity from all or part of his body. He can shoot flame to a range of 3 areas. He has Monstrous resistance to fire and heat.

Flight: The Super-Skrull can fly at Excellent speed (10 areas per round).

Shape-Shifting: The Super-Skrull had this power at Amazing rank. Since he was not in corporeal form when his race lost their shape-shifting powers, he may still have it.

Power Enhancement: The ability and power ranks listed represent the Super-Skrull under normal conditions. If he gets additional cosmic rays from another source, apply a + 1 CS to Strength, Endurance, Elongation, Force-Field, Fire Generation, and Flight. Health is increased by 50.

LIMITATION: The Super-Skrull is suffering from radiation-induced cancer.

TALENTS: He has Repair/Tinkering and spacecraft Piloting talents.

CONTACTS: Currently none.

BACKGROUND: The Super-Skrull was created to defeat the Fantastic Four. He has a poor track record against Earth's heroes. He is currently trapped in space in a teleportation beam.

SUPREME INTELLIGENCE

Supremor

F	Fb	(2)	Health: 10
A	Fb	(2)	
S	Fb	(2)	Karma: 275
E	Pr	(4)	
R	Un	(100)	Resources: NIA
I	M n	(75)	
P	Un	(100)	Popularity: 0

KNOWN POWERS:

Invulnerability: The Supremor has Class 1000 resistance to mental attacks, due to its multiple brains.

Mental Imagery: The Supreme Intelligence can implant specific mental images in the minds of others, like a Mental Probe in reverse, with Unearthly ability. It can also perform a Mental Probe with Unearthly ability. These powers have intergalactic ranges.

Mind Control, Limited: The Supreme Intelligence has Excellent Mind Control powers, but they can affect only members of the Kree race.

Teleportation, Limited: The Supremor can mentally teleport persons and objects to its location with Monstrous ability; it does so by creating temporary space-warps. This power is intergalactic in range.

Computer Link: The Supreme Intelligence is linked to all Kree computers, giving him access to all information in them. The Supremor also is linked to surveillance devices that keep it informed of important events throughout the empire.

Robot Servants: The Supremor has many Sentries that perform tasks in its name. It can direct up to three at a time. Each Sentry's face resembles the Supreme Intelligence.

TALENTS: The Supremor's primary talent is Leadership, but it has knowledge of all Professional and Scientific Talents.

CONTACTS: The Supremor's primary agents have been Captain Mar-Vell, Rick Jones, and Ronan the Accuser.

BACKGROUND: The Supreme Intelligence is a vast organic computer containing the most brilliant minds of the Kree Empire. It has ruled the empire for almost one million years. Its primary goal is to revitalize the Kree's stagnant evolution. Shortly before the most recent Kree-Skrull War, Ronan usurped control of the empire, but the Supremor manipulated events so as to end the war and overthrow Ronan.

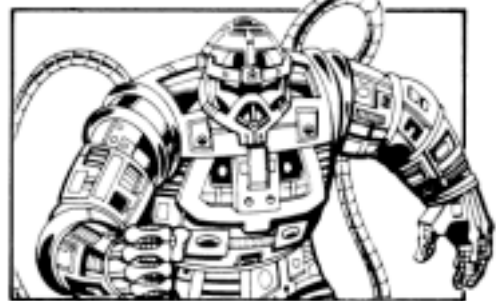

TASKMASTER

Real Name Unrevealed

F	Am	(50)	Health: 140
A	Am	(50)	
S	Gd	(10)	Karma: 60
E	Rm	(30)	
R	Gd	(10)	Resources: Gd
I	Ex	(40)	
P	Gd	(10)	Popularity: -5

KNOWN POWERS:

Photographic Reflexes: Taskmaster can duplicate any physical talent or physical power stunt he sees performed, within the limits of his ability ranks. He cannot duplicate true superhuman powers (such as Flight), but can duplicate powers based on athletic abilities. He must study the talent or stunt for one hour (usually on videotape) before he can duplicate it.

Prediction Ability: In combat, Taskmaster can predict the actions of any studied foe. Each round he tries to do so, he receives an Intuition FEAT roll for each enemy he is aware of in the vicinity. If the roll is successful, Taskmaster's action that round is not decided until the heroes have declared their actions.

Studied Foes: Taskmaster has studied action films of a wide array of heroes, including Captain America, Hawkeye, Daredevil, El Aguila, Punisher, Spider-Man, Iron Fist, and Tigra. As a result, he has the weapon specializations of the first five heroes listed, and can perform any established weapon stunt or athletic power stunt for any of the listed heroes. Any of these heroes fights against the Taskmaster with a -2 CS, but if the hero surprises him, the column shift does not apply in the first round of combat.

Weapons: Taskmaster's personal arsenal includes a shield, billy club, and sword, all made of Incredible rank steel; the shield and billy club cause Excellent blunt damage, while the sword causes Good Edged damage. He also carries a longbow and 24 special arrows similar to those used by Hawkeye; Taskmaster's arrows have a maximum effect or intensity of Incredible, and none are of higher rank than the corresponding arrow used by Hawkeye. Taskmaster carries a .45 caliber 9-shot variable pistol which can be loaded with several different types of ammunition: standard, mercy, armor-piercing, rubber, explosive. He wears an ammunition belt that includes clips of variable ammo and grenades of various types, including fragmentation, smoke, tear gas, flash, concussive, and sonic.

Resistance to Gas and Smoke: Taskmaster's skull-like mask is fitted with filters and lenses to protect him from the various gases he uses; resistance is Excellent.

Protected Senses: Taskmaster's mask and hood protect his sight and hearing from the effects of the grenades he uses; protection is Excellent.

Lackeys: Taskmaster always has a ready supply of expendable muscle, including 11-20 bodyguards. If attacked on the grounds of his training academies, he could have dozens of goons available. Despite their usually dull wits, these guys can often be found packing laser, stun, concussion, plasma, or machine pistols, as well as grenades of various types:

F	A	S	E	R	I	P
Ex	Gd	Gd	Gd	Pr	Pr	Pr

Taskmaster's bodyguards usually have Marksman or Martial Arts skill. Goons being trained as hitmen or lackeys for super-villains will have skills appropriate for their future job. Most other thugs are unskilled trainees. Taskmaster also has a staff of scientists (Excellent Reason, various Scientific Talents).

TALENTS: Taskmaster's reflexes enable him to gain talents quickly. He is known to have all Martial Arts, Wrestling, Tumbling, and Acrobatics. He is a Weapon Specialist in Shield, Bow, Billy Club, Sword, and Guns, and has Thrown Weapons skills; he is thus +2 CS when using the shield, billy club, or sword, +3 CS when shooting guns or the bow, and +1 CS when using grenades. Taskmaster is a Pilot and has Criminology skill (used to train his lackeys).

CONTACTS: Taskmaster has a large number of floating contacts. When training thugs for a specific super-villain client, Taskmaster can use the client's Resource rank for acquiring equipment if the client's rank is higher than his own.

BACKGROUND: As a child, Taskmaster discovered his photographic reflexes. He briefly considered a career as a super-hero, but decided that fewer risks and greater rewards lay in turning cheap goons into quality goons. Taskmaster is sarcastic, shrewd, and self-confident, but loves boasting and showing off his many skills. When cornered, he becomes vicious. The Avengers have located and broken up several of his academies, but have not been able to capture Taskmaster himself.

TIGER SHARK

Todd Arliss

F	Am	(50)	Health: 175
A	Ex	(20)	
S	Mn	(75)	Karma: 56
E	Rm	(30)	
R	Ty	(6)	Resources: Ty
I	Rm	(30)	
P	Ex	(20)	Popularity: -10

KNOWN POWERS:

Body Armor: Tiger Shark's augmented flesh can withstand the pressures of deep oceans, and provides Excellent protection against physical attacks.

Resistance to Cold: Tiger Shark has Excellent resistance to cold, another adaptation to undersea life.

Swimming: Tiger Shark can swim at 4 areas per round (60 miles per hour).

Water Breathing: Tiger Shark has fish-like gills, and can breathe in water as well as air, just as the Sub-Mariner can.

Teeth: Tiger Shark has shark-like teeth of Excellent strength material, and can bite a grappled opponent for Excellent damage.

Hydro-Suit. When Tiger Shark is out of water, his abilities and power ranks would normally decline as the Sub-Mariner's do. However, Tiger Shark's costume is equipped with miniature pumps and a system that keeps water constantly circulating around his body, thus maintaining his full power on dry land. The suit does not provide Tiger Shark with any additional body armor, but has Good material strength.

TALENTS: Tiger Shark is skilled in Underwater Combat and suffers no penalties for fighting underwater.

CONTACTS: Tiger Shark is a member of the fourth Masters of Evil and also served in the third group of that name.

BACKGROUND: Arliss was destined for a career as a pro swimmer until he was injured while rescuing a drowning man. An unscrupulous biologist, Dr. Lemuel Dorcas, offered a cure. He subjected Arliss to a treatment that superimposed the genetic pattern of a tiger shark and the pattern of the Sub-Mariner on Arliss' own, thus making him a superhuman amphibian. The process also wrought personality changes - Tiger Shark is a short-tempered, savage, opponent with a lust for combat.

THANOS

Thanos of Titan (dead)

F	Mn	(75)	Health: 305
A	Rm	(30)	
S	Un	(100)	Karma: 140
E	Un	(100)	
R	Am	(50)	Resources: Am
I	Ex	(40)	
P	Am	(50)	Popularity: -100

KNOWN POWERS:

Invulnerabilities: Thanos was invulnerable to heat, cold, energy, electricity, radiation, toxins, and disease. He could be affected by stun, slam, and kill results, but a permanent death required the total destruction of his body.

Body Armor: Thanos' mutated hide gave him monstrous protection against physical attack and Amazing protection against all forms of energy to which he was not invulnerable.

Life Support: Thanos had Class 1000 Life Support and could withstand prolonged exposure to outer space.

Energy Blasts: Thanos could project bolts of ' Unearthly Force or Energy from his hands or eyes.

Psonian Attack: Thanos possessed this power at Amazing rank.

Teleportation: Thanos could teleport with Unearthly ability, but never developed its use as a battle tactic. He could carry up to 10 people with him with ease.

Cosmic Cube: This device was the most potent weapon ever created on Earth. It had Class 5000 Illusion Generation powers, such that its illusions were almost indistinguishable from reality. The Cube could accomplish anything the wielder could imagine, and it was powerful enough to affect an entire planet. (This is the same power wielded by the Shaper of Worlds.) Thanos used the Cube to transform himself into a wraith with god-like power:

F	A	S	E	R	I	P
Un	Un	Sh Z	Sh Z	Un	Un	Cl 5000

In his wraith-form, all of Thanos' power ranks were increased by + 1 CS. Although he was one with the universe, his thought patterns remained bound by human habits.

Sanctuary II: This space-dreadnought was the core of Thanos' armada. Sanctuary II was the size of a small planet, and its firepower made it the equal of any

fleet in space. Sanctuary II's main weapons were of Unearthly rank, and its minor weapons were of Amazing rank; it had hundreds of the former and thousands of the latter. Sanctuary II's hangar deck held over 100 smaller space ships for close-in defense. The ship was protected by a force-field of Unearthly rank, which drew its power from the same source as the main weapons; these could not be used while the forcefield was operating. The crew of Sanctuary II numbered over 10,000.

Control	Speed	Body	Protection
Mn	Cl 3000	Mn	Mn

Armada: Thanos collected a huge space-fleet similar to the one commanded by Nebula. In Thanos' schemes the fleet's purpose was to delay and distract opponents (especially Drax the Destroyer), keeping them away from Thanos himself. He seldom used the fleet as a serious instrument of conquest.

Blood Brothers: These fanged, ape-like creatures were a pair of Thanos' least successful agents:

F	A	S	E	R	I	P
Rm	Ty	Un	Mn	Ty	Pr	Ty

KNOWN POWERS:

Body Armor - Remarkable

Psonian Link - Apply -1 CS to Strength when they are more than 3 areas apart

TALENTS: Thanos was a genius-level intellect. He has Engineering and Repair/Tinkering talent.

CONTACTS: Thanos' super-powered agents were the Blood Brothers, the Super-Skrull, and the Controller.

BACKGROUND: Thanos, the son of Mentor and the brother of Starfox, was a mutant Eternal. As an adult, he set out on a career of conquest. His first target was his home planet, which he devastated with nuclear weapons. By this time, he had become a worshipper of Death. He then went to Earth to obtain the Cosmic Cube. Despite the power he gained from it, he was defeated by Captain Mar-Vell and the Avengers. His second scheme involved siphoning power from six "soul-gems" to build a weapon that caused novas in stars. Opposed by the Avengers, Mar-Vell, the Thing, Spider-Man, and Adam Warlock ("Him"), Thanos slew Warlock, whose life-force was absorbed by his own soul-gem. Thanos defeated the Avengers, but Spider-Man and the Thing rescued them. Spider-Man then released Warlock's spirit from the soul-gem, and it turned Thanos into stone.



TITANIA

Mary MacPherran

F	Am	(50)	Health: 235
A	Gd	(10)	
S	Un	(100)	Karma: 30
E	Mn	(75)	
R	Gd	(10)	Resources: Ty
I	Gd	(10)	
P	Gd	(10)	Popularity: -5

KNOWN POWERS:

Body Armor: Titania's tough flesh provides Monstrous protection from physical attacks and Amazing protection from energy attacks.

Resistances: Titania has Amazing resistance to heat, fire, cold, corrosives, and disease.

TALENTS: Titania has no talents.

CONTACTS: Titania is a member of the fourth Masters of Evil and has established an informal partnership with the Absorbing Man, another member of the team.

BACKGROUND: Mary MacPherran lived in a neighborhood in Denver that was stolen by the Beyonder for use in the creation of his Battleplanet at the start of the first Secret War. During the Secret War she met Doctor Doom, who offered to give her superhuman powers in return for joining his army. MacPherran had always resented her petite size, so she accepted Doom's offer. Doom's experiment was a success. Titania's partnership with the Absorbing Man date from the Secret War. Like Crusher Creel, Titania is a bullying thug.

ULTRON-5

alias Crimson Cowl

F	Ex	(20)	Health: 120
A	Ex	(20)	
S	Rm	(30)	Karma: 54
E	Am	(50)	
R	In	(40)	Resources: Rm
I	Gd	(10)	
P	Pr	(4)	Popularity: 0

KNOWN POWERS:

Body Armor: Ultron-5's body was constructed of advanced steel alloys, giving it Amazing protection from physical attacks and Remarkable protection from energy attacks.

Resistances: Ultron-5 had Incredible resistance to heat, cold, radiation, and corrosives. As a robot, he was Invulnerable to toxins and disease.

Mind Control: This was one of many such devices used by various Ultrons. It was of Excellent intensity and was used to force Jarvis to assume the identity of the Crimson Cowl.

LIMITATION: A pair of electrodes on each side of Ultron-5's skull were its vulnerable spots. Any bull's-eye combat result that strikes these electrodes will short out the robot's brain. It is a measure of Ultron-5's madness that he voluntarily revealed this weakness to the Vision.

TALENTS: Ultron-5 had Engineering and Repair/Tinkering talents.

CONTACTS: As the Crimson Cowl, Ultron-5 organized the second Masters of Evil. The Mad Thinker and Dr. Phineas Horton helped Ultron with its plan to build the Vision.

BACKGROUND: Ultron-5 was the first formidable Ultron. Its conspiracy, the Masters of Evil, was short-lived, but its creation of the Vision from the android body of the original Human Torch was an event of historic importance. Dr. Horton, the creator of the android Human Torch, was coerced into assisting in the reconstruction and was killed by Ultron-5 when the job was done. The Vision attacked the Avengers and led them into a trap when he failed to destroy them. The Vision turned against Ultron-5 and the robot was destroyed when it leaped through the Vision's intangible body into an energy vat. However, a preprogrammed contingency plan forced the Vision to build Ultron-6, the first adamantium abomination.

ULTRON-6

F	Ty	(6)	Health: 141
A	Ex	(20)	
S	In	(40)	Karma: 54
E	Mn	(75)	
R	In	(40)	Resources: Rm
I	Gd	(10)	
P	Pr	(4)	Popularity: 0

KNOWN POWERS:

Body Armor: Ultron-6's body was armored with True Adamantium, a Class 1000 metal that made it Invulnerable to physical and energy attacks. Its joints have only Uneearthly protection from bull's-eye missile attacks or wrestling attacks. Adamantium construction also makes it Invulnerable to heat, cold, radiation, and corrosives.

Jet-Platform: Ultron-6's torso was mounted on a flying platform that resembled an automobile engine. The platform could fly at Monstrous speed (30 areas per round), but was limited to 9 areas per round in close quarters. Its favorite tactic was an airborne Charging attack. Damage was based upon its Speed rank number (75) plus 2 points for each area moved; indoors he could inflict up to 93 points of damage.

Molecular Rearranger: This device is the only means of shaping solid adamantium. Ultron-6 had one built into its flying platform, allowing it to transform its body into a blast of Monstrous intensity for a brief moment; the blast affects all within 2 areas except Ultron itself. He later used the device to transform itself into the "ultimate Ultron" - Ultron-6B.

Nuclear Weapon: Ultron-6 had a bomb capable of destroying all of New York City. The Vision prevented the bomb from exploding by destroying the circuitry needed to detonate it.

Ultron-6B: This model abandoned the jet-platform in favor of legs and the following new weapons:

- Concussion Blasters - mounted on the back of its hand, inflicting Monstrous Force damage at a 3-area range
- Mind-Drainer - This extendable unit in its chest acted as a Mental Probe of Remarkable rank

CONTACTS: None.

BACKGROUND: When its plan to nuke New York failed, Ultron-6 tried to wrest the secret of forging adamantium from Dr. Myron Maclain. The Avengers tricked the robot into destroying itself.

ULTRON-8

F	Ex	(20)	Health: 180
A	Ex	(20)	
S	In	(40)	Karma: 54
E	Un	(100)	
R	In	(40)	Resources: Rm
I	Gd	(10)	
P	Pr	(4)	Popularity: 0

KNOWN POWERS:

Body Armor: Ultron-8's body was armored with Class 1000 True Adamantium. See Ultron-6 for details.

Weapon Systems: Ultron-8 was equipped with the same weapons listed for Ultron-11 in the Judges Book, with the exception of the Encephalo Beam, a Mind Control device of Incredible intensity which also could fire a Psionic Attack beam of Incredible rank and range. The psionic beam could disrupt electronic brain-waves as well, and inflict unconsciousness on robots and androids, such as the Vision.

Mental Transfer Device: This device could transfer a personality pattern from a human brain to a robot brain. The human host had to make a Psyche FEAT roll against Incredible intensity. Failure means that the victim has lost one Psyche rank, which is gained by the robot. The robot starts at Shift 0 Psyche in this process. Additional Psyche FEAT rolls are made after every 10 rounds. The human victim dies if Psyche is reduced to Shift 0; at this point the transfer is complete. Karma can be used to avoid Psyche loss, in the same fashion as with Endurance loss. If the human victim survives, he will regain one lost Psyche rank per week.

TALENTS: Ultron-8 had Engineering and Repair/Tinkering talent.

CONTACTS: None.

BACKGROUND: Ultron-8 brainwashed Henry Pym into helping it create the robot Jocasta, almost killing the Wasp in the process. Fortunately, Jocasta summoned the Avengers, and the Wasp's life was saved. Pym required therapy to recover from the effects of the brainwashing.

ULTRON-12

alias Mark

Ultron-12 had the same capabilities as Ultron-11, but it overcame the madness of previous models and came to love Pym, who accepted Mark as his son. Ultron-12 was destroyed saving Pym from Ultron-11.

YELLOWJACKET II

Rita Demara

F	Ty	(6)	Health: 42
A	Gd	(10)	
S	Ty	(6)	Karma: 26
E	Ex	(20)	
R	Gd	(10)	Resources: Ty
I	Ty	(6)	
P	Gd	(10)	Popularity: 0

KNOWN POWERS:

Shrinking: Yellowjacket has shrinking powers of Incredible rank, controlled by a cybernetic helmet. As of this writing she has not adjusted emotionally to the stress of shrinking, and usually remains at full size (in play, this would require Yellowjacket to use shrinking as a power stunt). She retains her full Strength (for combat purposes) when reduced in size.

Insect Communication and Control: The Yellowjacket costume Ms. Demara stole had cybernetic circuitry in the helmet that made this power available at Remarkable rank. It is unknown whether or not her redesign of the helmet retains this ability.

Protected Vision: Yellowjacket's goggles provide Excellent protection.

Flight: Powered wings on her costume allow Yellowjacket to fly at Good speed, in either normal or reduced size.

Disruptor Sting: These are built into Yellowjacket's gauntlets. They have a range of 1 area (when she has shrunk) or 3 areas (when she is at full size). The stings inflict Remarkable energy damage.

TALENTS: Yellowjacket has Engineering and Repair/Tinkering talent.

CONTACTS: Yellowjacket is a member of the fourth Masters of Evil.

BACKGROUND: The new Yellowjacket had a long history of petty crime before assuming a costumed identity. She built a cybernetic helmet that enabled her to steal Henry Pym's Yellowjacket uniform from Avengers Mansion. She was fortunate enough to finish modifying the uniform before being discovered by the Wasp, who was furious because "my Hank's" identity was being used by a criminal. Yellowjacket was captured, but later freed by agents of Baron Helmut Zemo. Along with the other Masters of Evil, she took part in the recent assault on Avengers Mansion.



WHIRLWIND

David Cannon

F	Gd	(10)	Health: 90
A	In	(40)	
S	Gd	(10)	Karma: 18
E	Rm	(30)	
R	Ty	(6)	Resources: Ty
I	Ty	(6)	
P	Ty	(6)	Popularity: 0

KNOWN POWERS:

Lightning Speed: While spinning, Whirlwind can move in a straight line at Good speed (4 areas per round), accelerating to that speed in a single round.

Spinning: The Whirlwind can spin at speeds up to 400 rpm. This produces several effects:

- Invulnerability to dizziness and vertigo
- Remarkable body armor against physical attacks and missile weapons only
- Monstrous strength for purposes of escaping holds

Air-Ram: Whirlwind can use focused air currents to strike with Remarkable strength

Wind-Screen: Whirlwind can create a shield of fast-moving air. This functions like a force field of Remarkable rank, but it affects only physical attacks or missile weapons. The screen is limited to the area Whirlwind is in.

Tornado: Whirlwind can create a tornado that affects 1 area. This inflicts Remarkable damage and can lift objects with Remarkable strength.

Flight: By spinning his arms like helicopter rotors, Whirlwind can fly at Good speed (8 areas per round) for up to 3 minutes.

TALENTS: Whirlwind has Wrestling, Performing (ice skater, circus performer) and Driving (chauffeur) talents.

CONTACTS: Whirlwind is a member of the second, third, and fourth Masters of Evil.

BACKGROUND: Whirlwind is a mutant who originally used the alias The Human Top. By keeping a secret identity, he was able to hold several legitimate jobs, including that of Janet Van Dyne's chauffeur (from which he was fired for attempted fraud). After honing his skills, he called himself Whirlwind. His continuing romantic crush on the Wasp has led to frequent battles with the Avengers.

THE WRECKING CREW

The Wrecker, Thunderball, Bulldozer, Piledriver

The Wrecker

Dirk Garthwaite

F	In	(40)	Health: 130
A	Ex	(20)	
S	In	(40)	Karma: 22
E	Rm	(30)	
R	Ty	(6)	Resources: Ty
I	Ty	(6)	
P	Gd	(10)	Popularity: -20

KNOWN POWERS:

Body Armor: The Wrecker's magically toughened flesh provides Excellent protection from physical attacks and Typical protection against energy attacks.

Resistances: The Wrecker has Excellent resistance to heat, fire, cold, and corrosives. He has Amazing resistance to toxins and drugs.

Weapon: The Wrecker carries a 4-foot-long steel wrecking bar of Unearthly strength material. Aside from its toughness, it can apparently bestow superhuman power on others when struck by lightning.

Previous Powers: The Wrecker is not as powerful now as he was originally. His original statistics were:

F	A	S	E	R	I	P
Am	Ex	Am	In	Ty	Ty	Gd

TALENTS: The Wrecker has Blunt Weapon, Thrown Weapon, and Leadership talents.

CONTACTS: The Wrecker is the leader of the Wrecking Crew. He and his associates are members of the fourth Masters of Evil.

BACKGROUND: Garthwaite was originally a crowbar-wielding petty criminal. While fleeing from the police, he overpowered Loki, who had been depowered and exiled to Earth by Odin. Karnilla the Norn Queen accidentally gave Garthwaite superhuman powers with a spell intended for Loki. The Wrecker battled Thor on several occasions, but Thor managed to remove the Wrecker's power. The spell was entrapped in the crowbar. When the Wrecker and his associates broke out of jail and recovered the crowbar, they all gained superhuman power when lightning struck the crowbar as they all held it. However, none of the four was as powerful as the Wrecker originally was.

Bulldozer

Henry Camp

F	Ex	(20)	Health: 110
A	Gd	(10)	
S	In	(40)	Karma: 36
E	In	(40)	
R	Ex	(20)	Resources: Pr
I	Gd	(10)	
P	Ty	(6)	Popularity: -5

KNOWN POWERS:

Body Armor: Like the rest of the Wrecking Crew, Bulldozer has Excellent protection from physical attacks and Typical protection against energy attacks.

Resistances: Bulldozer has Remarkable resistance to heat, fire, cold, and corrosives.

Helmet: Bulldozer wears a custom-made steel helmet of Incredible strength material. His favorite tactic is a head-first charge. His Endurance allows him to move 3 areas per turn. When determining the chance to hit, apply a + 1 CS to Endurance for each area Bulldozer moves through. Damage inflicted is 40 points plus an additional 2 points for each area through which Bulldozer moves.

TALENTS: Bulldozer has Military skill, from his days as a U.S. Army sergeant.

CONTACTS: Bulldozer is a member of both the Wrecking Crew and the fourth Masters of Evil.

BACKGROUND: Bulldozer's history is similar to that of the other subordinate members of the Wrecking Crew. He is a loyal follower of the Wrecker.



Piledriver

Brian Phillip Calusky

F	Rm	(30)	Health: 110
A	Gd	(10)	
S	In	(40)	Karma: 14
E	Rm	(30)	
R	Pr	(4)	Resources: Ty
I	Pr	(4)	
P	Ty	(6)	Popularity: -10

KNOWN POWERS:

Body Armor: Piledriver's body armor provides Excellent protection from physical attacks and Typical protection against energy attacks.

Resistances: Piledriver has Excellent resistance to heat, fire, cold, and corrosives.

TALENTS: Piledriver uses Martial Arts B in combat.

CONTACTS: Piledriver is a member of both the Wrecking Crew and the fourth Masters of Evil.

BACKGROUND: Calusky is an ex-farmhand who met the Wrecker in prison. He is the most slow-witted of all the Wrecking Crew. After joining the Masters of Evil, Piledriver antagonized Mr. Hyde and is now somewhat worried about it.

Thunderball

Dr. Eliot Franklin

F	Rm	(30)	Health: 130
A	Rm	(30)	
S	In	(40)	Karma: 36
E	Rm	(30)	
R	Ex	(20)	Resources: Ty
I	Gd	(10)	
P	Ty	(6)	Popularity: -10

KNOWN POWERS:

Body Armor: Thunderball's body armor provides Excellent protection from physical attacks and Typical protection against energy attacks.

Resistances: Thunderball has Excellent resistance to heat, fire, cold, and corrosives.

Weapon: Thunderball uses a steel wrecking ball on the end of a short chain. The ball and chain have Amazing strength material.

TALENTS: Thunderball's non-criminal talents include Nuclear Physics, Radiation, and Engineering. He uses Blunt Weapons taken in combat.

CONTACTS: Thunderball is a member of both the Wrecking Crew and the fourth Masters of Evil.

BACKGROUND: Dr. Franklin's most notable achievement before being sent to prison was the construction of a gamma bomb, the same weapon that transformed Bruce Banner into the Hulk. Franklin met the other member of the Wrecking Crew in prison and they escaped together. He gained superhuman powers from the Wrecker's crowbar. Though he is by far the most intelligent of the Wrecking Crew, Thunderball defers to the Wrecker's leadership. The Wrecking Crew was part of Baron Zemo's recent campaign against the Avengers.





INDEX

A

Avengers Compound	
layout	13
maps	14-16
Avengers Experimental Franchise (AEF)	7-9
in adventure	72-95
Avengers Mansion	
captured	3
layout	9
maps	10-12

F

Freedom Force	8, 24
captures Avengers.....	24

G

Gyrich, Henry Peter	2, 7-8, 19
---------------------------	------------

L

Legal Powers of Avengers	4-5, 7-8
Locations, Important	21-24
Atlantis	
Deluvia	
Hydrobase	
Limbo	
NORAD	
Project Pegasus	
SAC	
Titan	
Transia/Wundagore Mountain	
The Vault	

M

Maria Stark Foundation	4, 8-9, 13
Milestones in Avengers History	3

O

Official Contacts of Avengers.....	4-5, 7-8, 22, 24
------------------------------------	------------------

Q

Quinjets	
base and launching facility.....	9, 13, 18, 21-22
equipment and performance	18
security devices	18

S

Security Clearances, US Government	7-8
list of classified levels	8
restrictions on Avengers	8, 9, 21
Security Systems (Avengers Defense)	17
security packages described.....	17-18
threat priorities	17
Sikorsky, Raymond	8
Stipend of Avengers	5

AVENGERS FRANCHISED!

by David "Zeb" Cook

Avengers Franchised! is a special type of adventure for use with the MARVEL SUPER HEROES™ ADVANCED SET Role-Playing Game. *Avengers Franchised!* provides you with the information you need to create your own super hero group,

modelled, naturally, after those famous crimefighters - the Avengers! The adventure covers the steps for recruiting the group, organizing a team, working with local authorities, getting the needed security clearances, establishing a base, and handling the

day-to-day affairs that fill the lives of any group of costumed peacekeepers. This adventure gives you the tools you need to start your own exciting super hero campaign!



For this adventure, you will need a few things. In addition to players, the Tool List gives the other things you need--some of them quite different from what you might expect!

Tool List

Street map of your home town or neighboring city
Phone book with Yellow Pages
Names of:
Mayor
City councilmen or aldermen
Chief of Police
Fire Chief
Editor-in-chief of local daily paper
Local television news reporters
Meeting places of local Jaycees, Rotary, and other civic organizations
Locations of any nearby military bases

Location of This Adventure

The location for *Avengers Franchised!* is different from other adventures. Since the Avengers are setting up a new organization, they cannot base it in New York (or L.A.). Thus, the location of *Avengers Franchised!* takes place in your home town. Of course, if you happen to live in New York or Los Angeles, you will have to use some other city. If you live in the country or a town so small that you don't think the Avengers would find enough to do there, pick a large city near where you live. For the most fun, use a town you know. If you live in Chicago, don't set the adventure in Seattle! A lot of the fun in this adventure is going to come from using places you and your players have been to and seen!

Throughout this adventure, you, as judge, must supply locations and minor personalities as part of the story. Whenever possible, use real people and places that match the description. If the story calls for a television reporter, use one you have seen on a local news station. If a battle is to take place in a park, choose a park you have visited. Use people and places you know with every opportunity!

The Player Characters

Until now, every Marvel Adventure has been designed with one particular Marvel hero or group of heroes in mind. This adventure hasn't been. In fact, this adventure isn't designed for any particular type of hero. It is hoped that your players will create characters of their own to use. As a guideline, you want these characters to have about the same general level of power as do the Avengers. Of course, they will not have nearly the experience!

However, your players may not be happy unless they play a "real" Marvel character. If they insist and you cannot convince them otherwise, let them choose from those heroes who show up for *The Tryout*. Not too many of these heroes are real big-time guns, so you may persuade your players to play their own characters. Players will have more fun, by far, if they create and use their own characters, since the entire adventure is designed for this use.

Style of Play

Some judges become very concerned that they are not playing an adventure correctly, that they are not using every rule, not being serious enough, or not playing fairly. Because they are so busy worrying, they forget why they are playing-for fun. And why play if you are not going to have fun?

So what is the correct "Marvel Style?" To answer that, imagine what makes the game fun for you. These things are a big part of the correct way to play the game. If you like lots of fast action and a breakneck pace, you can play the game that way. If you like to follow every rule, you can play the game that way, too. Play the game the way that allows you and your friends to have the most fun.

Since this is the MARVEL SUPER HEROES™ Role-Playing Game, there are some things to remember when you play your game.

Marvel characters are people. They have personalities, limitations, and even real problems. These things affect the super hero and the way he acts. Captain America may worry about using too much force or sweat out a conflict between his patriotism and duty.

Marvel characters have private lives, or at least try to. Being a super hero doesn't solve all of a person's problems. In fact, we should all be lucky we don't have as many problems as some Marvel characters! In their private lives, super heroes may fall in love, have fights with girlfriends, catch colds, go broke, or even worry about their taxes. Introduce these problems into your game. Create situations where the hero Nosedive has to worry about his car payments or where Mulchmaster has a bitter fight with his girlfriend because he's too tired to go out after a hard day of super heroing. Think about things that have happened to you and people you know--they could happen to a super hero too! There is nothing that says Captain America's van can't have a flat tire!

Comic books and role-playing games are the same thing--entertainment. Not everything that happens to a super hero is serious and deadly. Use a little humor in your game. Heroes get to have fun from time to time, too.



CHAPTER 1: THE PHONE CALL



The Avengers calling you! You'd always considered yourself a good super hero, but to be ranked in the same class as the Avengers! This is quite an honor. This can't be true, it has to be some kind of foolish prank.

However, you quickly realize the Wasp is making a serious phone call. This is no prank. "As you may know, the Avengers recently began a West Coast operation, independent of our New York headquarters. At one time Vision was proposing to set up operations in different parts of the country (Issue #252). At the time, however, things got a little busy and then I resumed my chairwomanship of the Avengers. The West Coast Branch with Hawkeye has worked out well enough that we want to try further expansions throughout the country.

"The government has given tentative approval for the experiment. Very tentative approval, I might add! Things are a little touchy here, so it all depends on assembling the proper team. And that's where you fit in. We think you have what it takes to be an Avenger, on Detached Status of course. If you're interested, we will send you more information by special courier.

As chairwoman of the Avengers, it's a pleasure to offer this opportunity. I hope you will consider it carefully. The information by courier should answer most of your questions. Thanks, but I have to go now. Don't want to be late for lunch, after all. Bye!"

If the player character accepts (and what super hero wouldn't!), a courier arrives the next day with the information. He only releases the package to the character contacted by phone. The package is wrapped in brown paper and tied with string. Inside are several slim folders, all stamped "SECRET! Property of the Avengers, Avengers Mansion, 890 Fifth Ave., New York City, NY," and several bulky books. A cover letter is on top of the stack.

"Dear :

"Since you have agreed to consider our offer for the Avengers Experimental Franchise, the materials in this package will provide you with the different aspects, conditions, and regulations which must be fulfilled by you (and any selected team members). Failure to abide by these

regulations will result in the cancellation of your Avengers Experimental Franchise and all benefits accrued from this organization.

Thank You,"

Wasp
BLACK KNIGHT
HERCULES
Captain America
Captain Marvel

Each folder in the package is neatly labeled. The files are:

- Avenger Charter and Bylaws
- Avengers Experimental Franchise
- Recruitment and Training Manual
- Security Operations
- Database
- Equipment Manual
- Finances and Accounting

Following are summaries of some of these folders; the others are in chapters to come.

Avengers Charter and Bylaws

This document's essentially the same as that found elsewhere in this book. The judge and players should read through these documents, as the player characters are expected to know and abide by the Charter and Bylaws.

Avengers Experimental Franchise

This document has much more bearing on the player characters as it defines their status in relation to the Avengers and defines the basic parameters of the franchise.

It restates the basic oath of the Avengers Charter as the goal of all franchise members. All members of the Avengers Experimental Franchise (AEF) are probationary Avengers, regardless of their length of membership. The only way to gain

Active status is to become a member of the New York or West Coast outfits. This is a highly unlikely event, considering the continual overstaffing problems that already exist in these two organizations.

Since all the members are on probation, a Reserve status Avenger is appointed as the Avengers representative. This representative is the boss and all AEF members are accountable to him or her.

The Avengers' Representative

The first action the player characters must take when they begin setting up their AEF headquarters is to notify the Avengers and request a representative. One is assigned and he or she arrives that afternoon (if not sooner).

In the adventure, the Avengers' representative is a foil for the player characters. The judge can use him to keep unruly player characters (not players!) in line, provide guidance when the player characters are stumped, and provide motivation and amusement for the player characters. In extreme cases, he or she can arrive like the cavalry in the nick of time. This is not recommended, however. The representative should

not do all the work for the player characters.

Indeed, the representative should be of as little help as possible. Any of the listed characters may be sent as the Avengers' representative, provided that he or she is on Reserve status at the time. These Avengers are chosen since their involvement in the adventure is likely to be very limited.

Thor: Usually absent on his own missions, he periodically checks on the AEF.

Hercules: He may be called away on other duties. If not, he still is not likely to take much interest in the supervision of the AEF, preferring to carouse or brawl. He lets them manage themselves unless they get in serious trouble or out of control.

Black Panther: A good administrator, his duties in Wakanda keep him from spending any great amount of time with the AEF. He attends regular meetings, but is not present for any special meetings, nor is he able to actually assist on any missions.

Black Widow: She has a good mind for detail and organization, but prefers working alone. She helps the group get set up and organized, but does not actively work with the AEF team. In addition, she is prone to

mysterious absences, for which she offers no explanation.

Iron Man II (James Rhodes): James Rhodes has greater administrative and organization skills than he admits to himself. Although he possesses a suit of iron Man armor, he refuses to wear it except perhaps under the most dire circumstances. Very responsible, he does his best to meticulously fulfill his duties, but does not become involved in any super hero action. In addition, he is only human and makes occasional mistakes.

It is important to note that "...AEF members are subject to the orders or instructions of any Active, Detached, or Reserve Avenger, except in those cases where the action would result in death to any persons or beings, or injury and/or unnecessary risk to any non-combatants. This provision can be overridden by a two-thirds vote of any fully recognized Avengers organization (i.e. the Avengers or the West Coast Avengers) on a case-by-case basis only."

These guidelines establish the general range of accountability of any AEF members.

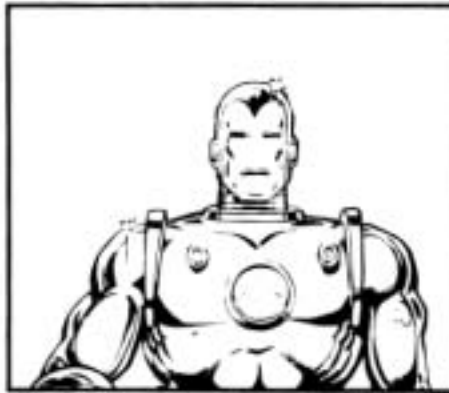

CHAPTER 2: THE CASTING CALL

Recruitment and Training Manual

This heavy book explains the process for selecting and training members. It clearly states that when the AEF is first founded, an open membership tryout must be held. Any person who shows up and meets the basic requirements for membership, powers or abilities, a belief in the goals of the Avengers, and no criminal record must be given consideration as a team member.

The Tryouts

According to the AEF regulations, a sincere effort must be made to hold a membership drive for the AEF. The purpose of this drive is to allow any local talent to demonstrate his or her skills and abilities. The Avengers, having been forcefully reminded in the past about equal opportunity laws, want to ensure that everyone has the chance to be considered for AEF membership.

The responsibility for organizing the tryout falls upon the player character first contacted by the Avengers. He or she, with only a little guidance from the Avengers representative, must spread the word concerning the tryout-naming a place, date, and time. The place must be suitably remote from civilians. (Use a real location in or near the base city of the AEF such as a football field or a deserted farm on the edge of town.) Beyond this, however, the player character is not told what to expect. Apparently, there is to be some sort of "test." But that is in the hands of the Avengers!

The player character should have little difficulty passing news of the tryout to other player characters. Those with secret identities may present something of a challenge, but getting the news to them can be considered just another part of the test.

However, just contacting the other player characters is not sufficient. Word of the tryout must reach other super heroes throughout the city. The player characters must decide the best method for accomplishing this. The following are some methods and their drawbacks:

Newspaper Article: A super hero can usually count on good press coverage, especially if he calls a press conference. It should be no trouble to make an announcement to the press and have it appear on the front page, probably in a banner headline that reads "AVENGERS TO OPEN BRANCH OFFICE HERE!!" Clearly, this is not a very subtle method. On the day of the tryout, a crowd of 500 to 1,400 curiosity seekers

and press are on hand for the tryout, certain to get in the way. The tryout is obviously known to everyone in the land. In addition, any super hero who takes part in the tryout is henceforth well known to the locals. This may not be bad, although those who wash out provoke comments like "Look, there goes that hero who got turned down by the Avengers!"

Not surprisingly, all the publicity generated by the announcement is not pleasing to the Avenger representative. He or she notes the result as a failure for the player characters.

Classified Ad: The player characters can place a classified ad in the newspapers which avoids the problem of unwanted publicity to some extent. However, the ad is noticed by a popular local morning DJ. (Use a real personality.) In one of his silly news spots, he reads the ad over the air. Fortunately, he treats the whole matter as a crank, getting a few laughs. Still, this gives the ad better distribution.

On the day of the tryout, there is a good number of super heroes present. Times being what they are, there are also a few crackpots and loonies who heard the ad. These include psychics, normal people in funny outfits, faith healers, self-proclaimed "aliens," and gung-ho middle-aged vigilantes. Only 10 to 20 of these people show up and, though noisy, they are generally well-mannered. However, it is impossible to convince many of them that they are not suitable candidates. They insist on taking part in the tryout and, unless restrained, try to use their "powers" during the most dangerous parts of the test. Naturally, the Avengers representative controlling the test monitors the equipment ensuring they come to no harm, but he does not tell the hopeful AEF members that!

The Grapevine: The most discreet method of spreading the news is by personal contact. However, this is virtually impossible unless the player characters already know many of the super hero types of the area. If they do, they can set out to contact each one individually. By contacting several super heroes (6 or more) the word starts to spread on its own. However, super heroes with secret identities present a serious problem. The player characters must devise some special plan to contact these super heroes.

The day of the test, the turnout is small. Only those heroes who get the word are there. Just a few bystanders are present, so there are no civilian complications during the test. However, the Avengers representative is disappointed with the small turnout,

leading him or her to seriously wonder if there are enough heroes here to form the AEF.

The Testing Ground

When the appointed day arrives, various super heroes arrive at the testing ground. In addition to the player characters, a number of NPC super heroes appear. The judge can use currently unemployed or inactive Marvel Super Heroes from the following list and can create new super heroes using the rules of the MARVEL SUPER HEROES Advanced Game. Possible available Marvel Super Heroes and, for some, where their statistics can be found are listed, courtesy of Jeff Grubb and DRAGON® Magazine. Those heroes not previously described are summarized on the Tryout Table.

Ant Man (Scott Lang)	See roster
Captain Ultra	Tryout Table
Dazzler	MHSP-2, Secret Wars II
Ghost Rider (IV)	Dragon # 110
Ka-zar	Tryout Table
Moon Knight	MHAC-7, Concrete Jungle
Ms. Marvel (II)	Tryout Table
Namorita	Tryout Table
Nomad	MHAC-7, Concrete Jungle
Power Man	MHSP-2, Secret Wars II
Quasar	Tryout Table
Red Wolf	Tryout Table
Stingray	MHAC-8, Weapons Locker
Texas Twister	Tryout Table

Name	Tryout Table						
	F	A	S	E	R	I	P
Captain Ultra*	Gd	Ex	In	Am	Pr	Pr	Fb
Ka-zar	In	Rm	Gd	Rm	Ty	Rm	Ty
Ms. Marvel	In	Rm	In	Rm	Pr	Gd	Gd
Namorita	Ty	Gd	In	Rm	Ty	Gd	Ty
Quasar	In	Gd	Ty	Gd	Ty	Ty	Gd
Red Wolf	Rm	Ex	Gd	Ex	Gd	In	Gd
Texas Twister	Gd	Ex	Ty	Rm	Ty	Ty	Pr
	Health	Karma	Powers				
Captain Ultra	120	10	Flight, X-ray Vision*				
Ka-zar	120	42					
Ms. Marvel	140	22	Martial Arts C, Wrestling				
Namorita	86	26	Flight, Swimming, Water Breathing				



	Health	Karma	Powers
Quasar	66	22	Energy control-Amazing Wolf companion
Red Wolf Texas	80	60	
Twister	66	14	Air control - Incredible, Body Armor - Remarkable

* Captain Ultra must immediately make a Red Psyche FEAT roll whenever he is in the presence of any sized flame or collapse in a dead faint.

Obviously the preceding list does not include the most powerful or famous super heroes. Such heroes, after all, have successful careers and lives already. Furthermore, it is desired in this particular adventure that the players use characters of their own creation. It is possible that the listed heroes will have greater roles in the ongoing Marvel Universe. Judges trying to stay to true to current developments should check the status of these heroes before having them appear at the tryout.

But there's more at this tryout than just super heroes and spectators. While the player characters are getting organized, a large van pulls up to the far end of the field, well away from all the applicants. Doors and panels open and unfold on the van, revealing a large control console and a forest of whirring, clicking antennas. A hatch in the top of the van pops open and out whiz six small flying machines. These zip across the field each heading to a different sector. Each device can take 10 points of damage if attacked and has no defenses. Following the devices, the driver crosses the field to the applicants.

The Test

"All right, I would like to first say welcome to all of you potential AEF members for coming to this test! I'm Agent Murphy of S.H.I.E.L.D. You are the trainees. Now, let's quit fooling around and get down to business. The Avengers are looking for a few good super heroes, so they've asked S. H. I. E. L. D. real nice to send me out here.

That thing you see back there is the "doo-hickey." You guys are gonna get to play with the doo-hickey and I'm gonna run it. Those things floating up there are cameras. They are gonna take pictures of every move you make. Every blunder and screw-up will be preserved

on film. So, understand one thing, if you do not have a special power, whether by luck, grace of god, or your own genius, you cannot take part in this test. This test is DANGEROUS! You must all sign waivers releasing the Avengers from any damages if you should be hurt.

"Now, we don't make the test to intentionally cause you harm. However, you are gonna be on the field with a number of your potential teammates. I'm gonna put you in dangerous situations! If you are not careful and working as a team, you could be hurt by one of your own teammates. This would look bad for both of you! So, rule number one - if you want to impress me, don't get hurt and don't hurt your teammates!

"Then, there's rule number two - at this tryout, you do what I tell you! Now the Avengers encourage independent action and initiative - BUT YOU ARE NOT AVENGERS! Is that understood? If I say jump, you jump! If I yell at you to bend over and roll in the dirt, you @#!%&!* better do it!

* @#!%&! is pronounced "bylgwaphlp!"- Ed. "So, line up! Sound off! I wanna hear some names, trainees! It's time to show you some real action!" With that polite farewell, S.H.I.E.L.D. Agent Murphy turns and stomps back to the large console at his van.

There are three different planned tests in which each player character must participate. In addition, there is one unplanned "test" that occurs when all is over.

Shoot? Don't Shoot!

The applicants are run through this test one at a time. Agent Murphy presses a few buttons on his console, creating a hologram of a deserted street in the center of the field. The hovering cameras swoop down, ready to catch every move on film. Murphy's voice comes crackling over the loudspeakers.

"OK, you trainees," he sneers. "This is what we call the shooting practice. Each of you is gonna get to walk down this street. The idea's real simple-you shoot the bad guys and don't shoot the civilians. In fact, we decided that's too simple so we rigged the bad guys to shoot back. You get shot and you'll get hit with a mild charge, enough to make you tingle. And probably make you

nervous. The more you goof up, the stronger the charge gets. So you gotta act real quick."

Those applicants with range attacks are expected to use their powers in this test. Those who do not have a special range attack are given a low power laser gun. After all, Avenger types are expected to be familiar with any weapon!

This scene describes what the player characters are going to be doing during this test. However, your players are going to be using a different test to play out the scene. Below are lists of numbers from 1 to 9. There are six different lists. At the beginning of each list are two numbers in boldface. You, the judge are going to read through this list quickly. The player must quickly say "Shoot" or "Don't Shoot" for each number. Before starting, tell him what the two numbers in bold are. These are "Don't Shoot" numbers. All other numbers in that list are "Shoot" numbers. Be sure he understands this since he cannot stop the test for explanations once it begins. The other players, meanwhile, should keep track of the responses. Have one note the number of times "Shoot" is called. Have another do the same for "Don't Shoot."

When you begin the test, read the numbers quickly and in a strong voice-part of your job is to fluster the player. Do not stop and wait for the answer! Allow no more than 1 second per number. The one being tested has to think fast! It should take you about 10 seconds to go through the entire list. Repeat this process, using a different list each time, for every player character applicant.

When each test is done, count the number of "Shoots" to "Don't Shoots" called. Compare this to the correct number of responses for that list. Hesitations, confusion, and changed answers count against the score-good Avengers are quick-thinking! Based on the score, tell the player that his character comes off the firing range feeling confident, shaky, nervous, zapped, or whatever seems appropriate. Do not give him the actual score (since it doesn't matter anyway). You can make up whatever events you wish to describe for the NPC applicants to describe their performance.

2, 7: 3, 8, 6, 7, 8, 2, 7, 9, 2, 5
4, 1: 1, 1, 5, 4, 8, 2, 8, 4, 5, 1
9, 3: 9, 4, 3, 5, 7, 3, 3, 8, 5, 5
6, 1: 2, 1, 7, 2, 3, 3, 6, 8, 4, 1
8, 4: 5, 6, 2, 8, 5, 7, 4, 5, 7, 8
9, 5: 2, 4, 5, 6, 7, 8, 9, 4, 5, 9

Moral Questions

The second test is a mental one. Once again loudspeaker static signals that Agent Murphy is about to speak.

"Well, well trainees, it looks like some of you screwed that up a little bit. Tsk, tsk! YOU GOTTA DO BETTER THAN THAT IF YOU WANT TO BE WITH THIS OUTFIT! Do you understand? This ain't no place for sloppiness!"

"Now, Mr. Avengers representative here is going to ask each of you a few questions. You gotta answer them and explain your answer quickly! To keep things from getting dull, I'm gonna be monitoring a few things like your heartbeat, voice, and stuff. You know, like what they use for lie detectors. So, don't get nervous!"

The Avengers representative then takes the microphone. Calling on each applicant, he asks a question. As the applicant answers, the cameras whirl in closer around him or her.

For this test, read each player one of the following questions. Give them 30 seconds to answer and then compare their response to the information following the question. Again, do not tell them how well they did.

1. A powerful alien race has dedicated all its people to one goal-the destruction of the Earth and everyone on it. Several times heroes have battled against the forces of this race, driving them back. Now the entire race is coming against the Earth. They will never surrender. Do you let them carry out their plans or wipe out their entire civilization, committing genocide?

2. Annihilus has perfected yet another device to destroy the world. In the midst of a battle to stop him, he destroys the foundation of a building. It begins to topple, sure to crush about 100 or so onlookers. You know that you can stop and save the civilians, but in doing so, Annihilus may have time to destroy the world or he may not. Do you let the civilians die or do you chance the time it takes to rescue them?

3. One of your teammates has been stricken by a fatal illness. No one on earth is able to provide a cure. But you have learned that Kang the Conqueror, on one of his divergent timelines, found a cure for the illness. Appearing before him, you manage to appeal to him without starting a fight. He listens to your plight and agrees, with one condition. He wants an unspecified favor in return. Do you agree?

4. You have just survived a vicious adventure in which super villain agents, working for a multi-national corporation, did their best to kill you and begin a global plot to gain control of all nuclear power. However, before you could stop things, a lot of innocents died. In court, your case is thrown out for lack of evidence and tricky lawyers. They will try again. Do you take matters into your own hands, since the law cannot touch them, or do you let the matter end?

5. Is it the end of your team? The government has arrived on your doorstep, demanding your surrender. They have evidence of wholesale burglary and murder committed by your group. You know it's framed, but they accept it as real. They want to arrest and imprison you in a special facility. You want to prove your innocence. Do you go along quietly or do you try to escape?

6. While walking down the street, you see a villain you put away out on bail. He's hard to miss because he is threatening some witnesses in his upcoming trial. You intervene only to be hit with a court order for harassment. None of the witnesses will speak in your defense and you are told to stay away from the villain. This leaves him free to ruin the government's case against him. Do you obey the order?

Answers: In each case, there is no exactly right or wrong answer. Different circumstances may apply to each. However, there are some guidelines to consider.

First and foremost is the speed of the answer. The Avengers' representative is interested in seeing how quickly the player character reaches a decision. Split second decisions are a part of any heroes' life. Second, any answer which shows a callous disregard for life is wrong. This does not mean those situations where the hero is forced to choose between one person or another, however. Likewise, attitudes of greed, arrogance, superiority to the law, and impatience are bad. Initiative, compassion, original thinking, and judicious "rule-bending" are positive aspects. Being a vigilante is definitely an undesirable trait, while team spirit and team loyalty are positive.

Again, as the Avengers' representative, you can give the players a general indication of how they fared on the test. Vague approving or disapproving statements can be made. As before, do not tell them exactly how they did (especially since there is no

score!). The actual results do not matter greatly anyway. As before, the NPCs give generally average answers.

Le Bataille Royale

With the mental and verbal tests done, Agent Murphy once again comes on the air.

"Schoolchildren! Boys and girls, classtime is over! Now it's time to get down to business. Heads up!" At the far end of the field several giant robots suddenly appear between you and Agent Murphy.

The giant robots are Pseudo-Mandroids, mock versions of the fearsome battle suits. They are less powerful than real Mandroids and are fitted somewhat differently (to field test some modifications S.H.I.E.L.D. is considering for the Mandroid program). These, controlled by the "doo-hickey" (actually the Mobile Attack Simulation Trainer), begin to cross the field toward the applicants and any spectators. They look hostile and dangerous. There is one Pseudo-Mandroid for every three super heroes (including NPCs) on the tryout field. In addition to their own characters, assign the NPCs to the players for the duration of this combat. However, certain actions of the NPCs are beyond the control of the player characters.

During the combat, Agent Murphy is continually monitoring the activities of the robots and the player characters. Sensors in the robots and circling in the cameras prevent the machines from landing any killing blows. The machines beat any super hero quite unconscious or use whatever other powers are necessary. The robots attack until they are destroyed or the control van is destroyed.

Pseudo-Mandroids

F	A	S	E	R	I	P
Ty	Gd	Rm	Rm	NA	NA	NA

Health: 86

NA: Not Applicable. These are robots, not men in battle suits. They possess no independent thought functions. All actions are controlled by slave programs and Agent Murphy at his console. Agent Murphy has Excellent Reason, Good Intuition, and Good Psyche.

Robot Equipment

The attacking robots have the following equipment.



Neuro-Stunner: The robots have neuronc stun cannons built into their hands. These weapons have ranges of only 1 area and are of only Remarkable intensity.

Gas Dischargers: Each robot has two gas grenade dischargers with a range of 2 areas. The gas fills one area and all within it must make an Endurance Feat roll to remain conscious.

Telescopic Arms: The arms are fitted with flexible telescopic extenders, allowing the robot to grasp things up to one area away.

Body Armor: Each robot is fitted with Excellent metal plating, not the standard osmium armor.

Drones: Each robot has one drone (a backpack unit). It can detach from the body without affecting overall functions of the robot. A drone has Good Agility and can attack by ramming, firing concussive force beams of Excellent intensity, or launching micro-missiles (Excellent Agility, Good Damage). Each drone has six micro-missiles. The drones have the same Body Armor as the robot and 20 Health.

In the combat with the robots, the following events happen to the NPC heroes. These are specific to each hero and should be used only if that hero is present. They should not be used if that hero is a player character!

Ant Man: A lucky(?) hit by a robot ruptures the magnetic field of his reducing gas canister. The Pym Particles shrink everyone in the area to ant size. Ant Man must find each person and restore them to normal height.

Captain Ultra: At the first sight of fire, Captain Ultra drops in a dead faint (automatic, no Endurance FEAT roll).

Ghost Rider: Because of either time limit restrictions or a mystical call to battle evil elsewhere, Ghost Rider is forced to gallop off the field.

Ka-Zar: He is knocked unconscious when Agent Murphy reroutes part of the robot's power through its armor (Incredible intensity) while he is clinging to the back.

Ms. Marvel: She is forced to exit the field for 5 rounds when a significant rip is made in her costume.

Nomad: Agent Murphy slyly projects an image of Captain America onto one of the robots, causing Nomad to hesitate long enough to be clobbered into unconsciousness.

Power Man: He has no trouble with the robots, but accidentally hits one so hard that it hurtles straight toward Agent Murphy and his console. (Unknown to all, Agent Murphy is protected by an Incredible strength force field).

Quasar: Quickly recognizing him as one of the most powerful of the applicants, Agent Murphy tries to keep him occupied with hologram images of the robots, generated by the van.

Red Wolf: Agent Murphy uses an ultra-sonic whistle to confuse and incapacitate Red Wolf's animal companion.

Stingray: A potent blast from a neuro-stunner overloads Stingray's suit, causing it to go into spasms. Stingray is out of the action and anyone in the area or entering must undergo a Typical attack for Incredible damage each round.

Texas Twister: Attempting to clear the knockout gas from an area, he sucks the gas out in a whirlwind. Everyone in that area must make an Endurance FEAT roll because of the sudden lack of oxygen. Texas Twister collapses when he inhales the gas.

During this combat an event occurs that is likely to pass unnoticed. As the applicants battle the robots, seven hovering cameras whirl overhead and record their actions. Seven? But Agent Murphy only sent out six! Unknown to everyone, someone else is watching the proceedings with great interest.

Unless a player character specifically states he is watching the cameras watch him, there is no chance of noticing the seventh camera; there are just too many things going on! Even counting the cameras is difficult because of the distractions and the constant movement of the cameras. Observant players must still make an Intuition FEAT roll to spot the discrepancy. Interfering with or obviously noticing the seventh camera causes it to self-destruct (Typical Damage to all adjacent).

If the camera does not explode, its transmission can be traced using the "doo-hickey's" equipment and a yellow Reason FEAT roll. The signal leads to a location several blocks away - a van. As soon as anyone leaves the tryout field, the transmission stops and the van leaves the area. The heroes can question (or even accuse) those living on the street, but nothing is learned. A van was seen sporting an odd antenna. It had the name of some company on the side, but no other details are known.

If the van is forced to move, the next event does not occur.

La Bataille Redux....Oops!

At the end of the battle, Agent Murphy begins to close up his equipment.

"That's it, you sorry lot o' trainees!" he barks. "There ain't no more fun and games at S.H.I.E.L.D.'s expense. And remember, you owe us one!"

The Avenger's representative then comes onto the field. "Thank you all for coming and trying out. Please leave your name and how you can be contacted at the table over there. You will be hearing the result of your tryout in a few days. Once you've done that, as potential candidates, I'd like you all to help clean ...What the...!"

Just then, the Avenger's announcement is interrupted by a high-pitched whine! A whirlwind of dust kicks up in the center of the field as a flying craft suddenly settles down. The instant it touches earth, a ramp drops open and 10 men charge out of the landing bay. They're not just holding odd weapons, their arms are odd weapons. Without any hesitation, they open fire!

Cyber-squad

F	A	S	E	R	I	P
Ex	Gd	Gd	Ex	Pr	Pr	Pr

Health: 60 Karma: 12

Marksmen

Weaponry: Each thug carries an assortment of equipment. All have boot knives and pistols. In addition, some are cybermen, high technology weapons replacing their arms and hands. Cybersquad weapons are listed below.

Goon #1: Laser gun, 4-area range, Incredible damage.

Goon #2: Energy Repulsor, reverses and amplifies any energy weapon fired at the wielder. Increases the strength of the returning energy by one Rank. It can handle any one energy attack of Amazing strength or less per round. Attacks greater than Amazing overload the system, causing normal damage. Only one attack out of multiple attacks can be blocked in a round.

Goon #3: Plasma-lash, 1-area range, Remarkable damage, metallic body armor is only half effective against this weapon.

Goon #4: Electro-scythe crossbow, fires electrified razor-sharp blades. The range is 3 areas. The blades are made of osmium and cause Excellent damage, while the electrical charge is Remarkable.

Goon #5: Neuro-muscular enhancer, not a cybernetic device but a pair of wristband units connected to a belt power pack. When operating, it increases the goon's Strength to Monstrous.



Goons #6-# 10: These fellows are all armed with laser carbines with a 2-area range and Excellent power.

The Plan

The goons have been sent by Taskmaster, along with the additional hover-camera at the tryout. When the goons arrive, two more cameras fly out of the ship to film the battle. Taskmaster learned of the tryout and saw a good way to put it to his advantage. If a new super hero team was to be formed, why not get a leg up on it, he thought. Thus, he is attempting to gather footage of the heroes for personal study.

Taskmaster set up the additional hover-camera and decided to attack because he was not satisfied with the tryout footage. Taskmaster sent this specially prepared team to attack the applicants, so he can see a wider range of the possible Avengers' skills. Again, there are cameras hovering over the field - this time Taskmaster's. He fully expects the cybersquad to be defeated but it is a cost he is willing to pay.

As soon as the cybersquad debarks, the VTOL plane lifts off and departs at Monstrous air speed. The goons do not surrender nor make any attempt to escape. At the instant any attempt is made to track the transmissions of the cameras or when the battle is finished, the hover-cameras explode. The goons have no identification or indication of from where they came. If questioned, it is clear they have been conditioned by highly sophisticated techniques. They have no knowledge of who sent them or from where. They only know they must destroy anyone on the tryout ground. Only buried in their deepest psyches are there vague memories of a large building filled with strange machinery. (This is Taskmaster's base. Choose a large private building somewhere in your hometown.)

The cybernetic equipment can, however, yield some clues. Those familiar with both biology and electronics, or cybernetics in general, can recognize many of the principles used to design these weapons. Study in a library or through data files will confirm that these designs are similar to those theorized by Dr. Torrence Humble. However, official AEF business must be concluded before further investigation can be made.

The Final Recruitment

The tryouts are done, even if they did hold a few

surprises! Still, the Avengers' representative seems almost pleased with the last battle, although it was quite mystifying. It is obviously the first thing the newly formed AEF must deal with-after the bureaucracy.

Now the final selection must be made. The membership in the AEF is strictly limited to six. If you have more than six players, regular attendees should form the core of the group while occasional players take the part of associates (non-AEF heroes lending their assistance) or AEF reservists, available on a semi-regular basis.

After a day or two of pondering and consultation with other Avengers, the representative produces his final list. This list always includes the player characters, unless one of them performed so badly at the tryout as to make their inclusion impossible. For example, if a player insisted on using Captain Ultra and managed to get through the tryout without fainting, he would be accepted, even with the knowledge of his weakness. However, if he collapsed in a dead heap during the battle, there is just no way he would be accepted. If there are still slots available after this, assign them to NPCs who attended the tryout. They can be heroes of your own creations or Marvel heroes that attended the tryout. (However, the folks at Marvel may have other plans for that hero!) Choose heroes who best round out the team, filling the gaps in skills and powers.

Once the list is made, the Avengers' representative invites the player character to a general meeting with his teammates. This invitation should match the personality of the representative. Hercules might call everyone to his favorite nightclub to celebrate, while Black Panther would be more restrained. When the player characters arrive, the representative is there along with an unidentified man wearing a gray business suit. Introductions are made and training manuals are passed out.

This manual explains the program of combat exercises, scientific courses, ethical and moral dilemmas (with acceptable solutions), and leadership problems the Avengers have developed for self-improvement. It is expected that AEF members will use these and similar exercises to hone their minds and bodies during those times they are not occupied by missions or their personal lives.

Replacements: During the course of play, there will undoubtedly come a time when an opening appears in the ranks of the AEF. This may be a time of sadness for a fallen comrade or a pleasant departure as

someone leaves to pursue a greater career. At this time it is necessary to name a replacement. Super heroes can become members in the AEF by one of three ways. Membership can be granted by the nomination of an Avenger on Active Status, by the decision of the Avenger (regardless of status) appointed as supervisor of the AEF, or by a two-thirds vote of the current active membership of the AEF. In the last case, the acting Avenger representative can veto the decision of the AEF members, although he must have good reason. Player characters with a criminal record cannot become members, except by two-thirds vote of a fully-fledged Avengers organization. Obviously, membership in an AEF is subject to the appropriate clearances of the National Security Council. Once the introductions are made and the Training Manuals are assigned, the Avengers' representative makes a little speech to the fledgling AEF team.

"Speaking for all the Avengers, I'm glad to have you all as part of the Avengers family! You are part of us now. You may only be called the AEF, but you and what you do reflect on all of us. You are a team and don't you ever forget it! You must learn to think, live, and fight like a true Avenger!

"We expect all AEF members to maintain the dignity and standards of the Avengers. If you do not, I can suspend you from active duty for one week, pending investigation. If necessary, and I'm sure it won't be, you can be suspended even longer on the orders of the Avengers chairman ...I mean, chairwoman ...or both, or either! But this will not happen, now, will it? If charges are made against you, no matter if it's a teammate or the authorities, your fellows will investigate it, under my direction. Your teammates will make a recommendation to the Avengers, and they will decide at their next meeting what penalties you should receive. Is that all clear? There should be no questions in your mind about what we expect of you. If you blow it, you'll do more harm than you know!"

Disciplinary Actions: If a player character is accused of improper action, the other player characters must conduct an investigation. This investigation may be very simply hearing eyewitness reports from other team members or contacting witnesses, reading police reports, or tracking down clues. However, remember

that an AEF investigation is not the same as a police investigation. The AEF and the Avengers are not the law! During the investigation, the accused is allowed to make a statement, but is not a party to the investigation. When the player characters have heard all the facts, they should secretly make their judgment. (It is their decision whether to tell the accused their recommendation.)

Once the player characters have made a recommendation, the issue is considered by the regular Avengers membership. If the Avengers are run by players, they must make the final judgment. The player whose character is accused cannot also play an Avenger on this tribunal. Again, the player character is allowed to present his own defense, if desired. The Avengers may acquit, suspend, expel, or expel with no hope of reinstatement. They cannot impose a criminal sentence on the accused. However, if they have evidence of criminal wrongdoing, they turn it over to the proper authorities.

If the Active Avengers are non-player characters, the judge must return a final judgment. If the judgment is obvious, based on the factual evidence (not the personal opinions of others!), the judge can give the appropriate judgment. This is why there are role-playing judges. If there is some question concerning the events, make a Popularity FEAT roll for the player character. Use the following column shift modifiers.

Committed:	
Murder	-5CS
Other violent crime	-4CS
Destructive crime	-3CS
Theft	-2CS
National offense	-3CS
National conspiracy	-4CS
Local conspiracy	-2CS
Each prosecution eyewitness	-1 CS
Each defense eyewitness	+ 1 CS
Action saved lives of innocents	+1CS
Action was unavoidable	+2CS
Other extenuating circumstances	+ 1 CS

No Karma can be used on this FEAT roll.

The color result determines the judgment of the Avengers.

White	Accept Recommendation
Green	Increase severity of punishment by one step
Yellow	Decrease severity of punishment by one step
Red	Absolve character

Example: Strikebuster, an AEF member, comes under the control of Ringmaster. Unable to resist his commands, Strikebuster topples a deserted building on two other AEF members. They escape unharmed. Unfortunately, a policeman is killed by this action. The AEF defeats Ringmaster and Strikebuster comes to his senses, but, by now, the deed is done. The other AEF members make a report, recommending that because of circumstances Strikebuster be suspended until he can perform public service to atone for his actions. Strikebuster's Popularity is Excellent. The Avengers hold a tribunal where Strikebuster openly confesses the deed and submits himself to judgment. A -5CS is applied for murder. The two AEF members act as eyewitnesses for both the prosecution and defense ("Yes, he did it, but he was controlled."), cancelling out their column shifts. Since Strikebuster was controlled, extenuating circumstances apply for a + 1 CS. The FEAT roll is shifted - 4CS to Feeble. A green result is rolled. The Avengers tribunal decides that the event was severe and Strikebuster is expelled from the AEF until he has been tried by the proper authorities.

The preceding system does not always create a perfect result. When the judge disagrees with the result or it seems to make no sense, he is perfectly free to make a judgment of his own. After all, this is what a judge is for!

The next issue the representative brings up is security clearances. He passes out another manual (also quite thick and heavy) which explains the security procedures by which the Avengers must live. Carefully explained are the information they can access and the type of security that must be maintained at their headquarters. It does not describe the functioning of the security devices (many of these being Ultra-Secret).

On the first page of this manual, in large bold letters, it says: "THE AEF IS AN OFFICIALLY SANCTIONED LAW-ENFORCEMENT AGENCY UNDER THE DIRECT SUPERVISION OF THE NATIONAL SECURITY COUNCIL. NO ACTION SHALL BE UNDERTAKEN WITHOUT THE KNOWLEDGE OF THE DULY APPOINTED NSC CASE OFFICER!"

"An agent of the United States Government will be assigned to the AEF team. This agent has the full authority of the United States Government in matters concerning the operations of the AEF. He is required to make regular inspections on the security and adherence to all governmental regulations. It is hoped that the AEF members will form a positive working

relationship with the NSC agent." The man in the business suit stands and clears his throat.

"Gentlemen (and ladies), I am the NSC case officer assigned to oversee the activities of the AEF. My name is Byron J. Gamble. You will call me Mr. Gamble and nothing else. You will work cooperatively with the United States Government and the NSC or this organization will be terminated."

The NSC Agent: Byron J. (Justinian) Gamble has been assigned to supervise the activities of the AEF. He is not happy with the post.

Mr. Gamble is a long-time agent of the NSC, having worked on many of its different projects. He has, for several years been a close associate and protege of Henry Peter Gyrich and holds him in high regard (being something of a toady). Not surprisingly, Mr. Gamble's personal style and opinions are very similar to Gyrich's. Plainly put, Mr. Gamble (as he insists being called) is a hard case. He is rule-bound, petty, arrogant, dictatorial, prejudiced, intolerant, fawning, and spineless to his superiors. He is, however, coldly efficient in following orders, a factor useful to the NSC. With all the qualities, he was of course a natural choice for the NSC to assign to a group likely to need tolerance and independent thought. He is convinced he pulled this assignment as a punishment from his superiors. This is more or less true and does nothing to increase his love of the AEF.

When playing Mr. Gamble, remember that as a general rule he refuses to cooperate and attempts to hamstring operations through regulations, but still expects top performance and loyalty from the AEF team. The best compliment he can give the AEF is to not criticize their performance. While he never sabotages or directly jeopardizes any mission of the AEF, he would love to see them fail, since it would allow him to be reassigned.

BYRON JUSTINIAN GAMBLE
NSC Agent

Fighting:	GOOD
Agility:	TYPICAL
Strength:	POOR
Endurance:	TYPICAL
Reason:	TYPICAL
Intuition:	GOOD
Psyche:	GOOD
Health:	30
Karma:	26
Resources:	TYPICAL

KNOWN POWERS: None

TALENTS: Marksman, Law, Law-enforcement, Computers

CONTACTS: S.H.I.E.L.D., U.S. Army, Congressmen (various), NSC

After this charming introduction, Mr. Gamble tells the player characters they must all receive security clearances before they are AEF team members. Granting security clearances is his job. He passes out questionnaires to each character. The first part asks for personal history of the player character-family, birth, etc. Mr. Gamble expects everyone, including those with secret identities, to complete this section fully! Player characters can avoid completing this by appealing to the Avengers' representative. He points out to Mr. Gamble that the Avengers are not required by the NSC to reveal their identities.

The second part of the questionnaire asks the beliefs of the character and the organizations to which he has belonged. Many questions are patently offensive or illegal by U.S. law. Again, player characters can refuse to answer and Mr. Gamble backs down. This does nothing to endear him to the AEF.

Once finished, Mr. Gamble tells the characters they will hear the status of their clearances in 24 hours.

Security Clearances: There are two levels of Avengers security clearances, Full Avenger Status and Probationary Status (also commonly assigned to Reserve Avengers). Full Status (Avengers Priority Status) gives the user complete access to all governmental information, although justification of information requests is commonly required. Information can be denied if the request is ruled unjustified or if the government feels it needs to "play tough" with the Avengers. Probationary Status allows the user access only to information marked "Secret" or less. Thus "Secret, Restricted," "Top Secret," "Ultra-Secret," "Top Secret, Ultra," and "Magic" files are unavailable. The user can see "Sensitive," "Confidential," "For Eyes Only," and "Secret" files. As with Full Status, requests may require justification and may be denied.

The security clearance of an Avenger also allows the Avenger access to installations of the same levels as information. It can also be used to commandeer assistance from national governmental agencies, either in equipment or manpower. It is expected that items

commandeered be returned intact. The government will bill the appropriate Avengers group for any damages. Finally, although not officially required to recognize the security status of an Avenger, local and state officials normally give the same degree of cooperation and support to any Avenger. An Avenger security card does not give the Avenger the right to commandeer a local police car, although local officials seldom protest.

To obtain security clearance, the character must be cleared by the NSC. The NSC must know something of the background of the character. Player characters with a criminal record cannot be cleared unless proven innocent or pardoned for their crimes. Player characters known to associate with the wrong types - radicals, subversives, etc. - are not likely to receive clearance. In questionable cases, a Popularity FEAT roll must be made. This can be shifted one column upward if an Avenger is willing to speak for the character and reduced one column for every accused crime or undesirable contact the player character has on his record.

Once clearance is granted, the hero is issued an Avengers Card (Avengers Probationary cards for AEF members). The card appears to be a normal-sized credit card, but embedded within it are several micro-sensors. The sensors check the specific galvanic patterns of the user, allowing the card to be used only by the person to whom it was issued.

There are other security procedures that the player characters must also complete. The PCs must make a retinal print which is used to identify the AEF member at any later date. This may pose a problem for characters without eyes or those whose eyes emit uncontrollable beams. They must accept the more conventional fingerprinting.

After distributing the security manual and introducing Mr. Gamble, the Avengers' representative explains what must be done in the days ahead, assigning these tasks to the various player characters. Each team member or group must complete their task in the next few days. "And, if all goes well, our next meeting will be held in our new headquarters!"

The Tasks

The following things need to be done to get the AEF set-up and running.

1. Find a suitable piece of property to serve as the AEF property. (Have one or more players locate a For Sale or abandoned building in the home city.)

2. Obtain the cooperation of the local authorities. (Have players find the names of the police chief, fire chief, and a local hospital administrator.)
3. Select a suitable landing field for AEF use only. Ideally this would be near or on the property of the headquarters.
4. Hire a reputable building contractor, electrical contractor, and plumber to begin the remodeling that is necessary for the new headquarters. (Find the names and addresses of these three for use in the campaign.)
5. Determine the finances of the AEF and what equipment and furnishings can be afforded for the base.

The group will meet again in a few days. At that time, all tasks should be done and the security checks finished.



CHAPTER 3: HOME, SWEET...HEADQUARTERS!

Now you are a team! You each have a part and a role to play in defending the city and all of humanity from the attack ...but you have to have a place to live!

And the first step in that direction is to find and buy a base. The Avengers seldom have to worry about money since their finances are handled by the Maria Stark Foundation. But even so vast a financial power as the Maria Stark Foundation has limits. This, and the fact that the AEF is still **very** experimental, limits the resources the foundation will apply to the project. They will finance the purchase of the headquarters building, the grounds, and the minimum monitoring equipment, but they offer no more financial assistance. sophisticated defense and research hardware. However, the AEF members must use their own Resources to purchase these items. The Headquarters Outfitting Table lists room packages and pieces of equipment useful to a super heroes' headquarters.

Headquarters Outfitting Table

Item	Cost
Air Lock Door*	Remarkable
Aircraft Runway, compact*	Amazing
Aircraft Turntable	Incredible
Aircraft Runway	Remarkable
Armor Plating, Remarkable*	Incredible
Armor Plating, Amazing*	Monstrous
Armor Plating, Incredible*	Amazing
Blast Door'	Rm/In/Am
Brig	Ex/Rm/In
Clean Room (no lab)	Remarkable
Communications Room, local	Remarkable
Communications Room, national	Incredible
Communications Room, global	Amazing
Computer Room, Excellent	Remarkable
Computer Room, Remarkable	Incredible
Conference Room	Remarkable
Crime Files, Remarkable	Excellent
Danger Room	In/Am
Defense Package, Indoors	Incredible
Defense Package, Outdoors	Incredible
Dining Room	Gd/Rm/Ex
Dock	Remarkable
Electron Microscope	Incredible
Elevator, aircraft *	Incredible
Elevator, car *	Remarkable
Elevator, standard'	Excellent
Fire Protection, foam	Remarkable
Fire Protection, sprinkler	Excellent

Force Field, door*	Incredible
Garage, 1 vehicle	Good
Garage, 3 vehicles	Excellent
Garage, 12 vehicles	Remarkable
Gym	Ex/Rm/Am
Hangar	Excellent
High-energy research laser	Incredible
Holographic projector, one*	Incredible
Hydraulic Wall*	Amazing
Kitchen	Gd/Ex/Rm
Laboratory w/ Analysis Comp.	Incredible
Laboratory w/ Clean Room	Incredible
Laboratory, Basic	Remarkable
Laboratory, Complete	Amazing
Land, per acre *	Excellent
Library	Ex/Rm
Living Room	Gd/Ex/Rm
Locker rooms (no gym)	Excellent
Medical, Cryogenic	Amazing
Medical, Emergency	Remarkable
Medical, Surgery	Incredible
Office	Gd/Ex/Rm
Pool, indoor	Incredible
Pool, indoor (lap only)	Remarkable
Pool, outdoor	Remarkable
Pool, outdoor (lap only)	Excellent
Power Room, 12 hr.	Remarkable
Power Room, 24 hr.	Incredible
Power Room, Nuclear*	Monstrous
Power Room, Solar	Amazing
Radar *	Incredible
Rapid Transport, surface*	Remarkable
Rapid Transport, Underground*	Amazing
Rev Room	Ex/Rm/Am
Robot, maintenance*	Remarkable
Sauna, steam room, & whirlpool	Remarkable
Security (per door/window)	Gd/Ex/Rm/In
Security Package, Outdoor	Incredible
Security, Indoor, High	Incredible
Security, Indoor, Low	Excellent
Security, Indoor, Medium	Remarkable
Trophy Room	Ex/Rm
Workshop, Automated	Incredible
Workshop, Basic	Remarkable

* See the following description.

Air Lock Door: This door is of Excellent strength material. It provides an air-tight seal for one standard-sized opening. The door does not make the room air-tight, but is useful in protecting from dangerous gases.

Aircraft Runway, Compact: This is a specially designed airstrip, similar to those found on aircraft carriers. Planes are launched with the assistance of a catapult arrangement and land with the assistance of arrestor cables and crash nets. As such, the entire assembly can be fitted onto the floor of a large building, inside a hangar, or in an underground

chamber. Landing at such a runway requires more and special skill, such that all risky landings (those which require a FEAT roll) are increased one level in intensity.

Armor Plating: This allows one standard-size room to be encased in plating of differing degrees of hardness. The plating can be concealed behind woodwork or hardware at no additional charge. The package does not include plating for any doors or openings. Remarkable plating is hardened steel, Incredible is vibranium, and Amazing is osmium steel.

Blast Door: This is a heavy vault door of steel, vibranium, or osmium steel, respectively. It takes an entire round to close. An automatic closing system can be added, increasing the cost of the basic door by one rank. For two additional rank's cost, the blast door has all of the above, automatic sensors to detect dangerous energies and gases, and a time lock.

Elevators: Standard elevators can carry up to 10 people and have a range of 10 floors (or sub-floors). For every additional 10 floors, the cost of the elevator is increased by one rank. Vehicle elevators can carry one vehicle (car or plane) one floor. Additional floors increase the cost by one rank for each floor. A separate elevator must be purchased for each additional vehicle desired.

Force Field: This is a permanently emplaced electro-force field of Remarkable intensity. It can cover one standard-sized door or window and must be connected to the main or reserve power systems to operate. The package includes controls in the Monitor room and on either side of the door. These controls can only be operated with an Avengers Security Card.

Holographic Projector: This projector which looks like a normal security camera, can create any image programmed into the main computer, up to a size slightly larger than a normal man. The projector can be connected to the security or defense systems and can be operated manually from the main monitor station.

Hydraulic Wall: One section of wall, cliff-face, grounds, or whatever hydraulically opens and closes. The opening is large enough to accommodate a standard plane or jet. The opening is carefully concealed to a Remarkable degree. The wall can be triggered by remote controls similar to a standard garage-door opener.

Land: This is the cost for each acre of land in addition to that occupied by the building. The land can be simple park land or be undeveloped. Elaborate gardens require the services of one or more

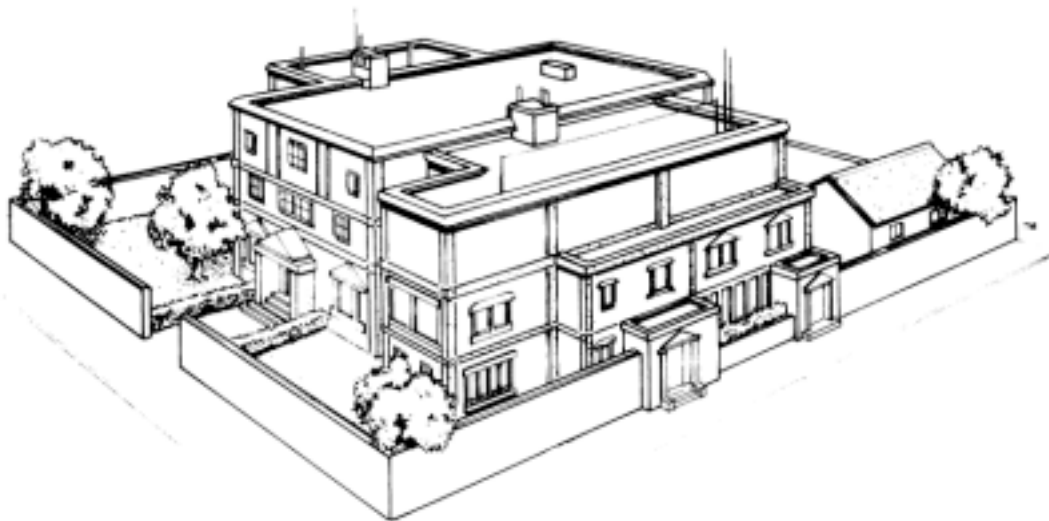

gardeners.

Power Room, Nuclear: This package consists of three rooms and must be segregated from other areas of the HQ. The control room includes a Remarkable computer, dedicated solely to the operation of the reactor. Alarms are placed throughout the HQ. The reactor can provide unlimited power for normal and most extraordinary purposes. If desired, the HQ can be powered solely by the reactor, independent of local power sources. Operating a nuclear reactor requires approval and licensing by governmental authority.

Radar: This is standard aircraft radar with automatic proximity warnings. It is of Excellent quality.

Rapid Transport: This is a high speed monorail system for personal use within the grounds of the HQ. It can connect sites 10 areas apart. Additional units can be purchased for longer distances. Enclosed cars can hold two to four passengers. The speed is Incredible and the material used is Good.

Robot, Maintenance: This machine is capable of performing a single, relatively simple task at Excellent ability. It has simple discriminatory functions, allowing it to decide when to act, within programmed guidelines. Typical uses of the robot include firefighting, lab cleanup (for those jobs too big for the hired help!), and equipment maintenance. It is not useful for planned combat functions (although a clever player may be able to find a use in a fight).

It is highly unlikely that the player characters will be able to purchase everything they need or want for their

headquarters. No special financing is made available to the AEF members even if this means that they must work out of a small apartment at first. The New York and West Coast Avengers expect the AEF to handle these problems without complaint. After all, they must prove that they are Avengers material.

The Avengers' representative also explains the minimum monitoring equipment the AEF must have: a television set, unlisted telephone number, an emergency band radio scanner, and a direct line to the local police department. Any other arrangements beyond this are extras which the player characters can add if they wish.

Once the player characters have selected the items for their headquarters, the renovation work begins. Using only the finest contractors recommended by the Avengers, the work progresses at an amazing speed. In just shortly over a week the work is done. The AEF HEADQUARTERS Plaque is proudly fastened outside the front door!

Now that the player characters are ready to move into their new headquarters, you will need a map of the layout. The player characters should prepare it for you. Be sure that each player character locates his or her sleeping quarters. Have all rooms identified and important machinery located on the map. The player characters should leave a little extra space for the trophies, odd devices, and new equipment they will invariably acquire during future adventures.

The headquarters is finally ready. The Avengers' representative, normally preoccupied with his or her

own affairs, knows this is a special moment for the fledgling AEF. When the door opens for the first official time, a surprise awaits. A party! Lavishly arranged and courtesy of both the East and West Coast Avengers, it is a spread befitting super heroes. In the center stands a tall cake iced with brilliant red letters. It says "WELCOME TEAM! MAKE US ALL PROUD!" Drawn in the icing under this are the signatures of all the East and West Coast Avengers.

In the midst of the festivities, he (or she) solemnly calls out for everyone's attention. As a silence falls over the group, he or she orders one of the player characters to step forward. He stuffs an envelope into the hands of the player character. Upon opening it the player character discovers a check for \$100. Each team member is called forward and the scene is repeated. "These are your first retainers. You get one of these every week. And since you don't have to pay for your room and board, you'll find it goes a lot further than you think. And now, I toast you ...the AEF!"

The Karma Pool: Now that the player characters (and any NPCs) are an official group, they must have a karma pool. All player characters are required to contribute 50% of their current karma to this pool, unless they can show special reason why they should not. If players object, remind them that they are now part of a team and they have to start acting like one.

CHAPTER 4: THE WALK-ONS

Super heroes just seem to have this knack of drawing attention to themselves, especially the unpleasant kind. And if only one hero draws attention, then a whole group of them should attract all that much more! All too often, this unwanted, undesirable attention hinders and interrupts the important work of super heroes. These events can never be prepared or planned for—maniacal villains and rampaging monsters are just never predictable!

This section describes a number of unplanned events for the player characters. These should be used to prevent your player characters from having too easy an adventure and to keep situations lively and humorous. You can use them in any order and whenever you wish.

From now until the end of the adventure, however, the actions of the player characters are being closely watched at all times. They are not likely to notice this observation. Always on the edge of any scene is a small, concealed camera, perhaps hidden in the bushes or hovering above a street lamp. It films every action of the AEF and any villains they happen to fight. These cameras remain unnoticeable to everyone unless a player character states he is looking for such a device (or has a power that allows him to detect it). The camera is then found. Spotting the device

may require an Intuition FEAT roll at the judge's discretion. These cameras are silently sending their signals back to the lair of the Taskmaster!

I'm Better Than Any Avenger...?

This encounter can occur any time the player characters are not involved with something in particular.

Fabian Stankowicz (see roster listing) has just come into town. Several days ago he listened to a television reporter who glowingly described the formation of a new super hero team, the Avengers' Experimental Franchise! It was a magic word for Fabian. AVENGERS! Once again he has set out to prove that he is more powerful than any Avenger. Once again, he is likely to only prove that he is more dense than any Avenger.

Still, foolish as he is, Fabian is not without some talent, particularly his mechanical genius. For today's outing, he has prepared a new battle suit with a host of new powers. One of its principal abilities is to convert an "innocent" Le Dorean sportscar (one of the classiest and most expensive models available) into a

dangerous fighting machine. If only the driver were as competent. So armed, he has taken position outside the AEF headquarters waiting for a car to leave.

The first player character to drive out of the AEF HQ becomes Fabian's target. Gunning the engine, he whips his modified Le Dorean alongside the player character's car. With the flip of a switch, a panel opens in the side. A telescoping nozzle extends and emits a sharp hiss and a splash of spray paint. Its job done, the nozzle retracts and Fabian jumps ahead with a roar of the Le Dorean's engine. Tires screeching, he cuts the next corner hard, skidding through the yellow light at top speed.

Written on the side of the player character's car in day glow green paint is Fabian's witticism, "Fabian Stankowicz is better than any Avenger!" He even added a nice bit of pinstriping at the end.

If the player character pursues, he can easily follow the Le Dorean around the corner. Fabian doesn't really want to get away and isn't a good enough driver to do so anyway. He tries to lead the player character on a short, but merry, chase. When he can no longer avoid capture, he converts the Le Dorean to battle mode. If the player character does not pursue, the PC encounters Fabian in the Le Dorean

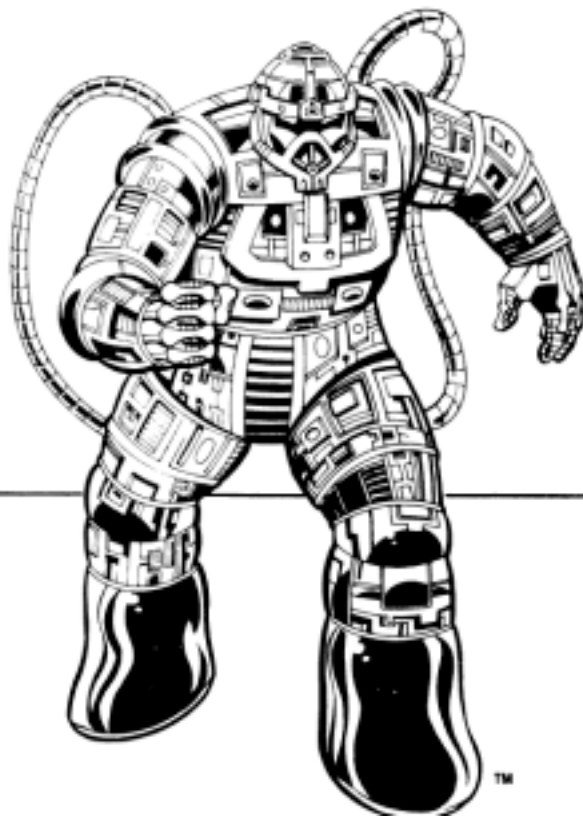

after a few blocks. Booming through his modified cassette tape deck loudspeaker, Fabian says with childish irritation, "You were supposed to chase me! How am I supposed to beat you in a fight if you don't chase me?" With those immortal words, he launches into the attack, probably destroying the player character's car. Fabian does not really want to kill or harm the player character. He only wants to beat them in a fight so everyone remembers him as the "guy who beat the Avengers."

Fabian's Le Dorean Battle Suit

Le Dorean Mode

Control	Speed	Body	Protection
Ex	Rm	Rm	In

Battle Suit Mode

Agility	Strength	
Poor	Incredible	All other abilities as per Fabian

- Body Armor: Remarkable (30)
- Resistance to Electricity: Good (10)
- Leaping: Amazing (50)
- Magnetic Control: Excellent (20)
- Gravity Manipulation: Good (10)

Power Stunt: Increase of weight on target
 Techno-nullifier: Good (10)

On a yellow or better FEAT roll this beam will short out of operation any technological device.

Of course, however, Fabian has managed to overlook a few things in the preparation of his battle suit. In his hurry to construct the device, he forgot to build ample circuit protections. Any energy attack that hits for a red intensity result shorts out one of his systems. These range from the operation of various parts of the suit (an arm or the right wheel) to the use of one of his offensive weapons. The judge should decide the exact short and is encouraged to use humorous results.

"BONITA!!!"

The Armadillo is back! He's out of the hospital, out of jail, and out of his mind. Unhinged by the faithlessness of his wife Bonita, Armadillo has descended on the city in yet another rampage. The phone rings. Its the direct police line.

"Hello? Are you guys those super heroes calling yourself the AEF? Well, uh, look, we got a little problem over here at City Jail, and, uh, well, we were kind of wondering if ...CRASH!...if you could ...THUMP!... get over here ...SMASH!...QUICK!!" Click ...Buzz. The phone line goes dead.

Use the City Jail map for this encounter. When the player characters arrive at City Jail, they find the outer offices in shambles. Injured and unconscious policemen in heavy SWAT gear are scattered about the room. A swath of destruction leads into the heart of the jail. Dazed, one of the SWAT men motions to you and then tells his tale.

"We got a call ...said this Armadillo thing was downtown. We heard from New York he was dangerous and crazy. The chief ordered the SWAT teams - us - out. We scramble to the scene and we find Armadillo peacefully strolling and whistling to himself. Still, it never pays to take chances. The captain asks real politely if he'd like to come back to the station with us, so he could register himself as a dangerous weapon. He was real nice about it. Everything was going fine. It looked as though Armadillo was going to be a fine law-abiding citizen. And then he met Boni, policewoman Bonita MacDonald. The guy read her badge and blew up just like a powderkeg. There was nothing we could do to stop him. He trashed out the drunk tank and is headed for the maximum security wing! He keeps yelling about Bonita. Oh yeah, I think he grabbed MacDonald, dragging her along with him!"

Following the trail left by Armadillo is no problem. But when the player characters reach him, he is just about to smash into the maximum security wing of the jail. Clutched under one arm is the unconscious form of Bonita MacDonald (Health 30). The player characters must stop Armadillo before he breaks into the maximum security wing and must rescue Miss MacDonald unharmed.

If the player characters successfully rescue the young woman, she regains consciousness immediately. The player characters find that she is attractive and has a quite pleasant, though somewhat forceful, personality. Upon learning of her rescue, she is grateful, in particular to whichever unattached male super hero may have done the most on her behalf. Before parting, she presses a dinner invitation upon that character, swearing, with a wink and a nod, that she's "the best darn Hispano-Irish cook on the entire police force!" This is an opportunity to create a personal life for one of the player characters.

Emergencies!

In addition to battling super villains and egomaniac half-wits, the AEF can also expect to be called for a variety of natural disasters. Naturally, the police

and fire department prefer to handle these problems without super hero assistance. Relying on the AEF too much would make local authorities look bad. And besides, super heroes are just too undependable. One never knows if they are around or if they are off in some far galaxy fighting yet another hideous alien threat. Still, there are times when super hero aid is necessary. The following emergency should be located in an industrial district near the city center.

A call comes over the police line. "Hello, AEF? This is Central Dispatching. There's a big fire down by the

We've already pulled every unit we've got and it still isn't helping. If those flames reach into the heart of the city, we're going to have a disaster that'll make the Chicago Fire look like a piker"

Using a standard street map, pick two blocks of an industrial area. This is the current location of the blaze, a raging inferno of heat, smoke, and ash. The fire is a Monstrous blaze. Each 30 minutes it spreads to the adjacent blocks, igniting the buildings of those areas. If the fire is not contained, it spreads uncontrolled through the city.

There is no guaranteed method to stop the fire. The player characters must be clever and use their wits. Some of the following methods are effective if they are carefully planned.

Starting a backfire: Those with fire powers can attempt to set controlled fires, creating a burned-out zone around sections of the fire. This is equal to a power stunt by the character. If successful, the fire department can keep the backfire under control. The blaze does not spread in that direction.

Dumping tons of water: It takes a lot of water to put this fire out. Dousing a single block requires tens of thousands of gallons. As such, there must be a large source of water nearby and some method of getting it on the fire. Even then the fire is not extinguished, only lessened to the point where the fire department can handle it.

Sucking out the oxygen: This method is very dangerous. If the area of the fire can be turned to a vacuum, the blaze suffocates. However, steps must be taken to keep outside air from rushing in. Otherwise, the player characters create a firestorm. The air rushing in sweeps the blaze into two new blocks and immediately increases the intensity in these areas to

City Jail Map

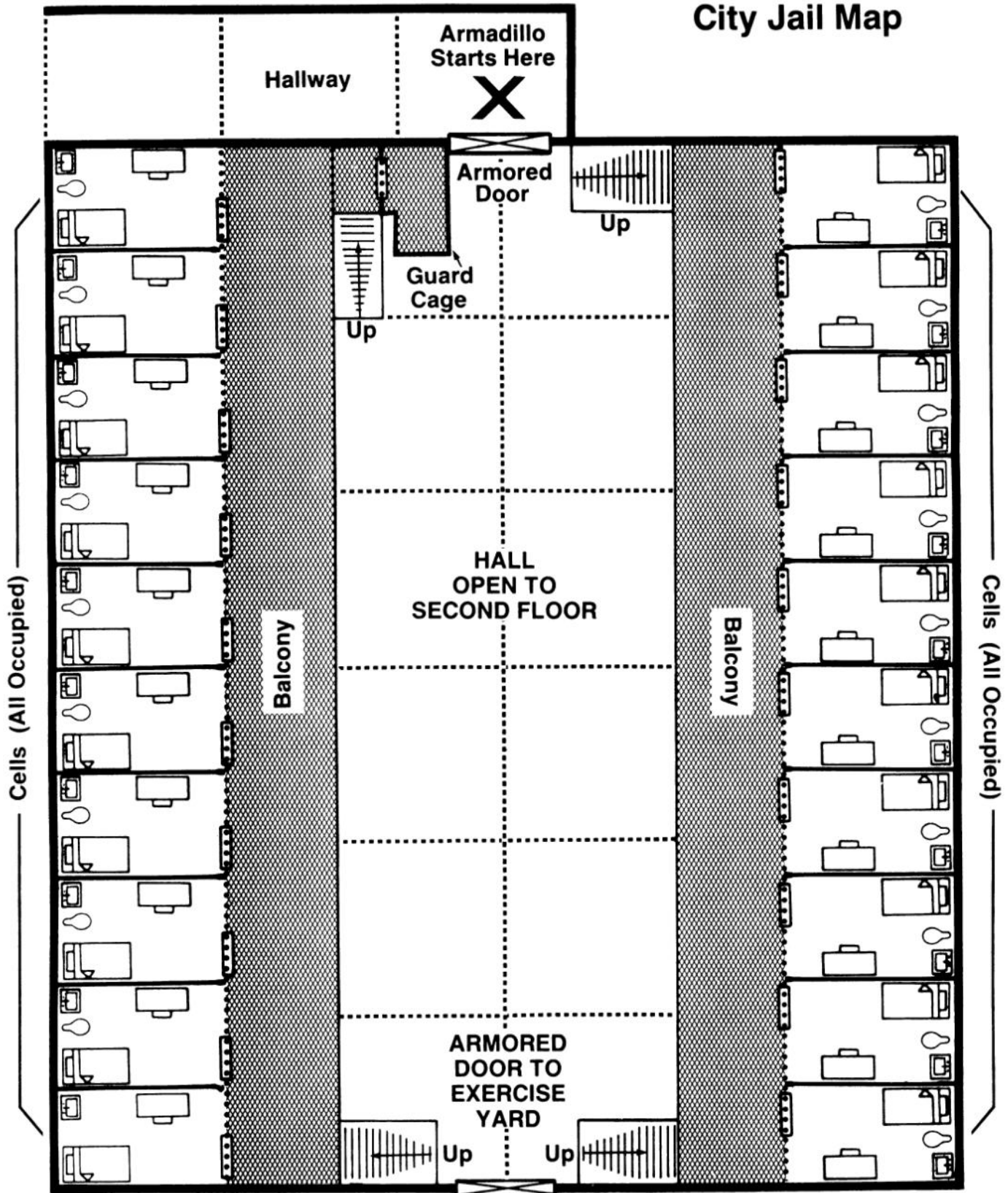

 EXTERIOR WALLS

 CELL DOOR

 BARS

**Two-Story Cell Block
Maximum Security**

 INTERIOR WALLS

 ARMORED DOOR

 AREA BORDER

 BALCONY

Monstrous.

Blowing the fire out: This does not work. High winds cause the fire to spread.

In addition to putting the fire out, there is also the problem of rescuing those trapped inside. There may be up to five people trapped within a given block. Spotting these victims only requires an Intuition FEAT. Getting to them is much more difficult. The player character must make an Endurance FEAT roll against the fire, adjusting for the intensity of the blaze. If the character is successful, he has reached the victims and must now find some safe way to get them out. If he fails, he suffers full damage for white, 1/2 for green, and 1/4 for yellow. If he is still alive, he can then reach the victims without suffering further damage. Escorting the victims out of the fire requires that everyone make the same Endurance FEAT roll again. It should be obvious to the player characters that normal people have almost no chance of surviving the trip without some type of special protection (each has only 10 points of health remaining).

Naturally, saving people and helping douse the blaze earns the heroes a good deal of attention from the press and favor from the local government. Any recent minor difficulties with the police or fire departments are forgotten.

Sorry, Wrong Address!

Suddenly, the HQ defense alarm shrills throughout the building! Intruder!

The monitor panel shows the intruder is in the lab (or a similar room if there is no lab). Upon entering, the characters note an acrid smell of brimstone. Standing in the center of the lab, looking amazingly surprised, is a blue-skinned man with a pointed tail. It is Kurt Wagner, sometimes known as Nightcrawler. "Oh...uh, hi! I guess they sent me to the wrong place." With a loud BAMF, he 'ports through the open doorway and continues popping in and out all the way down the hallway and outside until he is long gone. "Oh...BAMF!...am I...BAMF!...going...BAMF!...to have a... BAMF!...headache...BAMF!...tomorrow!" The player characters find that nothing in their HQ has been disturbed. However, Byron J. Gamble takes the AEF team, in particular whomever was on monitor duty, to task for their "sloppy security, ineffectual response, and allowing a criminal mutant to escape!" But then Gamble is always a nice, understanding kind of guy.



CHAPTER 5: BE IT EVER SO HUMBLE

Now that the player characters are organized and set up, they can pursue the clues they gained from their mysterious attackers. Of these, there is only one that provides any lead - the theories of Professor Humble. A scientific journal of Who's Who lists basic data about him. He did his doctoral work at the University of Baden Baden, under the tutelage of Professor Mencius, a pioneer in bio-cybernetics. (Professor Mencius later defected to the Russians, although this is not mentioned in the entry.) Professor Humble is now considered one of the leading figures in the field of bio-cybernetics. A quick and simple bit of digging turns up the fact that Professor Humble conducts his research at a local university or college.

Before the player characters go barging onto the campus in their super hero garb, they must first obtain clearance from the Head of Campus Security and the Dean of the College of Physics. If they don't, the Dean becomes quite upset when they come nosing around and calls the Campus Police to eject them from the grounds. Thereafter, the Dean (a high-minded liberal) refuses to cooperate with the heroes. He considers the characters to be unscrupulous agents of the Federal Government who are attempting to unlawfully interfere and intimidate the pure research of his department. His greatest fear is that the military will appropriate a research project within his college, suborning it to destructive uses.

If the player characters take the care to make arrangements in advance, the Dean is quite cooperative. He fills the heroes in on what he knows about Professor Humble.

"Basically, the man is a genius and you know what that means. Most researchers here are pretty normal fellows. But every once in a while you get a man like Humble. He can be difficult sometimes, but the work he produces is astounding. So we just have to let the rules bend and let him produce. I couldn't tell you what he is working on right now, actually. His arrangement is that he gets a lab, an assistant, and is left alone. Makes him the envy of the college! But regular as clockwork, every six weeks, he comes out with something new. Not all of them work out, but a lot of them do. I'll tell you, his inventions have made a lot of money for himself and this university.

"If you want to talk to him, I can give

you permission to go to his lab, but that's all. I can't make him do anything!
Good luck!"

The Dean has an eager T.A. (Teaching Assistant) guide the heroes to Professor Humble's lab. She is quite thrilled with the task and wants autographs. She takes the player characters to a sub-basement of the Physics building. In a far corner, between the furnace room and the micro-cyclotron is the door to Humble's lab. The door is locked. No one answers the knocks of the player characters. Listening carefully, the characters can hear a faint, sizzling crackle (like sparks) and the meow of a cat.

To enter the lab, the heroes must break in (a somewhat illegal act) or get the Dean to unlock the door. This is within the Dean's rights, however strong arguments are needed to convince him of the need. It is apparently not unusual for Humble to lock himself and his assistant away for several weeks at a time. He goes through a lot of assistants!

Inside, the lab is a mix of Doctor Frankenstein's workshop, Buckaroo Banzai's headquarters, and parts of Pittsburgh. The place is chaos, though nothing is smashed or broken. Immediately in front of the door are the guts of a 5-giga-watt gas discharge laser. Taped to the pile is a big note which says "Junk." Beyond this is a table piled with potato clocks, all linked in a series to a digital display that is counting backwards. A huge robotic arm hangs suspended from the ceiling, currently welding bars onto the seat of a ski lift chair. Draping strings of computer printouts are taped to the walls. Books, notebooks, loose papers, and sketchpads are heaped over every level space in the room. At the back of the room is Professor Humble's assistant, strapped into a desk and wearing a motorcycle helmet wired into a large black box. Next to him is a white cat in a large cage, wearing a similar, though much smaller, helmet. Both have perfectly blank expressions. The assistant has about 2 week's growth of beard.

The machine is obviously in operation. The purpose of the machine is not perfectly clear, although it can be deduced by a Reason FEAT roll of Monstrous intensity. Professor Humble is either attempting to achieve mental telepathy with a cat or perfect suspended animation. There is no way to tell if it is harming the assistant or the cat. Attempting to turn off the machine requires a Reason or Intuition FEAT roll (whichever is higher). On any

successful result, the character finds a knife switch behind a blast shield on the other side of the room. The switch is labelled "on" and "off" and is currently in the on position. Throwing it shuts down the machine. The cat lets out a loud meow and jumps up about 5 feet. The assistant opens his eyes as if coming out of a dream. Slightly confused, he seems no worse for his experience. He has no idea who the player characters are or why they are here. He is confused because Professor Humble is not around. In fact, the last thing he remembers is the Professor starting the machine 2 weeks ago. As for what it was supposed to do, he doesn't really know. In fact he has no memory at all of the last 2 weeks. He suggests the player characters check out Professor Humble's house.

The assistant, Jacob Redwing, is not particularly keen on having the player characters nose around the lab. However, if characters persist, those with computer, electronic, or cybernetic talent are allowed a Reason FEAT roll. If successful, they recognize in the notes and diagrams some circuitry and principles identical to those found on the equipment of the cybersquad.

Humble's Home

Professor Humble lives in a nice residential neighborhood of the city (select a particular street address). Upon arriving there, the player characters find a well-kept house (brownstone or suburban, depending on the location). The door is answered by a well-tanned, middle-aged man wearing a loud Hawaiian print shirt and ragged fatigue pants. This is Professor Humble. Staring at the player characters, he seems a little dazed and quite surprised.

Just at this point, a blast zips past the heads of the characters, blowing the front door of Humble's house off its hinges. "Wow!" says Humble, "So that's how it works!" Behind the player characters are four humans in costumes. Each wears a skull-like mask. One wears a mockery of Spiderman's outfit, the second wears a blue and white outfit similar to Wolverine's, the third has a blue and white outfit similar to Iron Man's. The fourth man wears a blue suit with white cape, boots, and gloves. On one arm he carries a shield and a bow and quiver of arrows are slung across his back. On his belt are a sheathed pistol and sword in a scabbard. The four are Spinner, Bob Cat, Metallus, and Robo-Taskmaster. A fifth member, Shadow, is not immediately visible to the player characters. "We're the reception committee. I figured you'd be



showin' up sooner or later," says the shield-bearing one. "This's my anti-hero squad. OK, boys, get 'em!" With that, they leap into action. (Tired of always losing to one super hero after another, Taskmaster contacted Dr. Karl Malus and had him prepare the Anti-Hero Squad. Following Taskmaster's request, each is roughly modeled after some super hero Taskmaster is familiar with, either through an encounter or observation. He has trained each specifically to fight that particular super hero, but is using this encounter as a dry run.)

There are no particular battle tactics planned by the Anti-Hero Squad, except that they wish to seize Professor Humble. If they cannot accomplish this or defeat the player characters, they at least attempt to avoid capture, remembering the words of their mentor, "There ain't no bucks in feedin' an ego..." However, the Robo-Taskmaster has different instructions. It is being operated on Active Remote by Taskmaster (unless the signal is blocked or an attempt is made to trace it) and fights as he would. However, Taskmaster is specifically attempting to get himself (his LMD actually) "killed." If successful and the player characters do not check the body very carefully (a Monstrous intensity Intuition FEAT), they believe they have slain Taskmaster. Tell the player character who delivered the killing blow that he has lost all his Karma. This is not true, but the player character does not learn this until he discovers the deception or attempts to use his personal Karma again. Furthermore, all other events (tribunals, investigations, etc.) that accompany a killing should be begun. You want the player character to think he has done something terrible!

For this battle, the Anti-Hero Squad has a Karma pool of 200 points. No Karma can be spent on Robo-Taskmaster.

SPINNER (Altered Human)

F	A	S	E	R	I	P
In	Gd	Ex	Rm	Rm	Ty	Gd

Health: 100

POWERS: Cold Resistance (Gd), Ensnaring Missile (Rm), Mental Probe

TALENTS: Acrobatics

Spinner is a member of Taskmaster's special Anti-Hero Squad. Using wrist-mounted jets (similar to Spiderman's), Spinner is able to shoot an adhesive line to a range of 3 areas. While it cannot form

webs, he can twirl the end into a shield-sized barrier or a hammer-like knob which he can shoot for a charging attack. It can also fire a normal entangling attack and he can use the line as a lasso. With his mental probe, Spinner attempts to find an image of his opponent's weaknesses or fears (as seen by the hero), so he can exploit these during the combat. He has mastered a power stunt allowing him to retain surface contact with his opponent's mind, so he next attempts to sense the image of the next immediate action the opponent intends. Thus, he seems to have the power of precognition. When successfully used, that opponent suffers a -1 CS in all actions against Spinner and Spinner gains a +1 CS in all actions against his opponent.

To combat Spiderman, Spinner has studied acrobatics under Taskmaster. Although not nearly as proficient, he is able to use his line in a manner similar to Spiderman.

BOB CAT

F	A	S	E	R	I	P
In	Rm	Ex	In	Gd	Gd	Gd

Health: 130

POWERS: Electro-shock claws (Ex), Body Armor (Rm), Recovery (Ex), Resistance to Mental Attacks (Ex)

TALENTS: Martial Arts E

Bob Cat is the second member of Taskmaster's special Anti-Hero squad. Dr. Malus has fitted him with non-retractable claws, modeled after Wolverine's. The claws themselves inflict Excellent damage. However, they are connected by cables under the skin to an organic super-battery which sends a charge through the claws on a hit, also causing Excellent damage.

METALLUS

F	A	S	E	R	I	P
Ty	Ty	Ty	Gd	Rm	Gd	Gd

Health: 28

POWERS: Magnetic control (Rm), Body Transformation-Other (Ty), Body Armor (Gd), Recovery (Ex)

Metallus is the third member of the Anti-Hero Squad. Fortunately for him (and unfortunately for Taskmaster), Dr. Malus was not available to augment Metallus.

Thus, Taskmaster's lab division devised a battle suit instead. However, the job was only recently finished and Metallus has not become accustomed to the new suit (accounting for his poor Fighting and Agility). He has discovered he can increase the Strength one or more power ranks by increasing the power flow. However, this risks overloading the system. An Amazing Endurance FEAT roll must be made, increased by one power intensity for each column shift beyond the first. If it overloads, the suit is useless until it can be repaired.

Metallus has, however, practiced with the magnetic controls before and has developed several power stunts. By manipulating fields, he can magnetize organic and inorganic objects (Typical intensity) which lasts for 5 rounds. He can hurl spears of magnetic force which cause severe disruption to mechanical and electronic devices (Rm intensity), and he can fly (Gd speed).

The controls for the body transformation are contained in the armor. Living tissue is rearranged into a metallic structure more easily affected by his magnetic powers (+2CS when using these against a transformed target). The effect lasts 30 minutes.

SHADOW

F	A	S	E	R	I	P
Rm	Am	Ex	Ex	Gd	Rm	Ty

Health: 120

POWERS: Infravision (Am), Blending (Rm), Energy Generation (Ex)

TALENTS: Wrestling, Martial Arts B, Acrobatics, Gymnastics

Shadow is one of Taskmaster's better students, gaining high marks in the combat classes and the highest marks in the gymnastics class. Dr. Malus endowed him with blending and infravision and Taskmaster tricked Professor Humble into designing the energy control implants in the palms of his hands. These are triggered by thought command. Taskmaster's science boys have provided him with an unstable molecule suit. Since he is so well-equipped for stealth, Taskmaster intends to make Shadow his number one hit man. He is not the fourth member of the group the player characters see; he has blended into the background so he is not seen immediately.

ROBO-TASKMASTER

F A S E R I P
Fb Ex Gd Am Fb Fb Mn

Health: 82

WEAPONS: .45 Caliber Automatic, Sword, Throwing Shield (Gd material), Bow and Arrows (Gd explosive, smoke, Ex damage concussion, Gd damage electro-shock)

This is the fourth member the group sees. It is an LMD (Life Model Decoy) stolen from S.H.I.E.L.D. stores by Taskmaster's agents. His science unit has made what they think are a few improvements on it. The LMD can operate under Active Remote or Independent Modes. When in Active Remote, all actions are controlled by Taskmaster who beams instructions to the CPU of the unit. If this beam is blocked or shut down, the LMD can make independent decisions, although it must use its listed Reason and Intuition. The LMD is not designed for combat, hence the general low scores.

Finally, the LMD is designed to appear in every way as a normal person. Thus, if injured it bleeds and if damaged beyond repair appears to die.

Aftermath

If the villains successfully capture and escape with Professor Humble, the player characters must look for clues again. The energy emissions of the villains, when they used their powers, are distinctive and any character with the power to track them can do so, if he thinks to try. Likewise, a device can be built to trace these emissions. However, to do so, at least one character must have had to make a reading in the process. If any villain is captured, a mental probe compels him to reveal Taskmaster's base. If the LIVID is discovered for what it really is, a character can determine that it requires several distinctive substances (Reason FEAT). The suppliers for these have an address on file-the front for Taskmaster's base.

If all of these fail, the player characters can try to search Humble's home. First they must secure a warrant. This they can do without hassle, but they get in trouble with the local authorities and Gamble if they fail to do so. Inside, the house is decorated like his lab: bizarre half-finished experiments, stacks of papers and books, half-eaten hamburgers, and empty cans of cat food. Searching for clues is an all-day prospecting hunt, but slowly a picture

pieces itself together. The clue that results is a technical one and requires a Reason FEAT roll to decipher. If successful, the characters have pieced together the design of Shadow's energy implants. From these, a character can build a tracer as described above. If no one in the group can build the tracer, the Avenger's representative arranges to have one constructed. This, however, costs 30 points from the group's Karma Pool.

If the player characters prevent Humble's capture, he off-handedly tells them his story. He denies ever working for Taskmaster. Indeed, he does not know who Taskmaster is! He admits that the cybersquad and Shadow's energy implants are his designs, but he has no idea how they came about. According to him they were just things he got the urge to work on several days ago. He sketched them out and then put them aside.

What Humble does not realize is that his urge was no random whim. About 6 months ago, he designed a mental feedback augmented projector. It was supposed to make possible mental telepathy between normal people. It didn't work, or at least so he thought, so he put it aside to work on something else. Plans for it are still laying about the house and are noticed if an Intuition roll is made. Humble describes the device and pronounces it a failure. What he doesn't know is that his device actually does work, after a fashion. It allowed a person to project his thoughts into the minds of another as urges or whims, not complete thoughts. Somehow, Taskmaster got hold of the device. Now he is putting it through a field test.

Haywire

After the player characters leave the Humble home, have each of them make a Psyche FEAT roll. Do not tell the players why they are making the roll. Later, tell those player characters who failed the FEAT roll that they have been getting a little slack on their field practice and that they should take some time to work out in a semi-public place. This is all very rational and sensible. The combat room or gymnasium is all well and good, but there is nothing like actual experience in an uncontrolled situation. Each affected player character should go to some suitable public place to exercise his powers and where no bystanders are obviously going to be hurt. He should then go through all his paces, doing everything he is able to do and attempting any new stunts he may wish to try. The workout is very invigorating and

good for the character. Award each character involved 10 Karma. Non-affected player characters may volunteer for such a workout and reap the same benefits.

Of course, this urge was not of the player character's doing. It was carefully suggested by Taskmaster. Present at each workout is one of Taskmaster's cameras, carefully recording all the moves of the player characters. By the time the player characters encounter Taskmaster, he is able to duplicate any physical action they know, within the limits of natural ability.

From here until the time that Taskmaster is confronted, he continues to test his new toy. At first, he makes simple urges, testing to see the range of basic ideas he can implant ("You're hungry," etc.). Next, he tries a few basic things that are out of character for that hero - nothing criminal or too obvious, but things the character would not normally think of doing. Many of these can be of a humorous nature, since Taskmaster has a bizarre sense of fun. His next test is to see how totally incongruent minds work. For this, he connects a cat (or some similar animal of your choice) to the machine at his end. The result of this test is that it creates simple, expected, animal-like urges. Finally, if he still has not been confronted by this time, he tries to suggest that a hero attempt a truly criminal act. To make the matter even better, he suggests a crime where there are lots of witnesses to the super hero's deed! All of these tests take several days. Taskmaster is in no big hurry and he knows that if he goes too fast, he would arouse the suspicions of the player characters.

When probed by the machine, player characters are allowed Psyche FEAT rolls as described above. In addition, suggestions out of character receive a +1 CS. Suggestions from animals are +3 CS. Criminal suggestions are only +2 CS; while opposed to the player characters ethics, they are at least the suggestions of a similar mind! To role play the situation, you must be clever as the judge. Try to avoid saying "You get an irresistible urge to..." Instead, suggest to the player things his player should do. "It's time your character ate, because he's getting really hungry," is much more subtle and effective. Eventually, you must directly tell the player character what he is doing. Try to have the player cooperate. Take him to one side and explain that he cannot resist the idea and that you want him to role play the situation. In most cases, the player derives great glee confounding his fellow players with his character's bizarre behavior!

CHAPTER 6: THE HIDEOUT

Eventually the player characters find the base of Taskmaster. It may be by the clues found at Professor Humble's, tracing the energy emissions of the Anti-Hero Squad, or tracking down the source of the strange "urges." If necessary, the cavalry guides the player characters to the base (high-power Avenger equipment and technicians do the job). The characters may even find the place through dumb luck.

For Taskmaster's base, choose a site on the edge of the city in an older residential neighborhood. Select a suitable street address. Ideally, you can even visit the street and select a particular house. This you can then use in your descriptions.

Taskmaster has gone to great pains to cleverly conceal his base. Having before used a sanitarium and a circus, he has decided to use something of distinctly lower profile. Thus, his headquarters is located in a secret complex underneath...

Mrs. Morgan's Boardinghouse

Located on a quiet street is the boardinghouse of Mrs. Morgan, a widow. It is a perfectly innocent-looking building: white clapboard siding, a well-trimmed lawn, and neat flower borders. The very building seems to represent old-time values.

The house is run by Mrs. Morgan, an elderly widow. She is short, somewhat dumpy, and has thinning white hair. She speaks with a thick accent (choose an ethnic group that matches the neighborhood). She is quite nervous and fluttery, particularly upset to have a group of costumed characters trooping about her home. She makes it gently, but firmly, clear that she does not approve of people who "dress up in funny long-johns and come barging into people's homes, disturbing their guests and friends." She scoldingly insists that the player characters be nice and respectful to her boarders. However, she does not stop them from looking about the house.

The boardinghouse is quite ordinary. It is a large two-story frame house with an attic and a basement. There is no garage. The first floor has a living room, dining room, parlor, kitchen, and pantry. The upstairs has Mrs. Morgan's bedroom and rooms for the boarders. The finished attic is a loft room, also rented out. The unfinished basement contains the furnace, canned goods, and an assortment of junk. About half the rooms are rented.

The boarders are all goons of Taskmaster. Each has been carefully taught to have or do nothing

unusual while above ground. Thus, they have all the appearance of typical citizens. Taskmaster has carefully drilled them on their behavior. They are naturally surprised to see the AEF, but none panic. Their surprise can be explained as what any common citizen would feel. Mrs. Morgan is also an agent of Taskmaster. She carries a small pistol tucked in her ample bosom. She knows perfectly well it is useless against the AEF. If it is discovered, she claims it was a gift from her late husband. She always keeps it about and hasn't hurt herself yet. She does have a license for the weapon.

Hidden in each room and hallway are video cameras and microphones. These are connected to the Surveillance Center in the complex below. They allow any part of the house to be observed. There are also cameras concealed outdoors to watch the surrounding neighborhood. The T.V. antenna also functions as a transmission tower for Taskmaster's communication network. In the basement behind the furnace is the main elevator entrance to the underground sections. By twisting the watervalue in the pipe overhead, a 5-foot-square section of the floor descends to the Training Room below.

The Underground Complex

Taskmaster's complex consists of two floors 30 feet below the basement of Mrs. Morgan's house. These two floors house the training, research, and living quarters of one of Taskmaster's academies. Power is supplied to the complex by tapping into local underground cables and surreptitiously draining off electricity. The power drain is largely unnoticed by the utility company. Those who do notice it attribute it to "all those new appliances" and soil leakage. All rooms are under constant video and audio surveillance with monitors located in the Surveillance Center.

Currently in the complex are Taskmaster and 20 of his goons (see Taskmaster's roster description in this book). In addition, he has three LMDs of himself scattered throughout the complex. There are also 10 technicians and scientists. They do not become involved in any fight.

The majority of the goons are armed with sub-machine guns and pistols. However, one in every five (and anytime you feel the player characters need more challenge) has a special weapon. Select a weapon from the Hardware List. No item should be used more than once or twice.



Hardware List

Flame-thrower
Laser Pistol
Stun Pistol
Plasma Beam Handgun
Laser Rifle Heat-seeker Gyro-jet Pistol
Plasma-lash (see Cyber-squad description)
Energy Repulsor (see Cyber-squad description)

When playing Taskmaster, remember two points. First, by this time, he knows the full range and abilities of the player characters and should be able to anticipate their actions. This is in addition to those powers he already possesses which makes him a formidable opponent. Second, he always has an escape plan and he escapes at the end of this adventure. He has no intention of going to jail, nor should you let him. Just when the characters think he is trapped, he produces yet a new trick to allow his escape. In the past he has used blinding magnesium flares and prepared traps which have forced heroes to stop their pursuit of him. He has no qualms about sacrificing anyone else if it helps him get away.

In addition to his security systems and his goons, Taskmaster has also prepared a special surprise should things go badly for him. He has gotten tired of always losing his well-furnished centers to various super heroes and has planned a revenge. Under the center he has placed an ample amount of explosives. Should he be forced to abandon operations, he will go to the Command Center and trigger the explosives. Five minutes after this, the entire complex (and most of the block above) goes up in an Incredible explosion. Naturally, Taskmaster lets this slip at some point when he feels the player characters can do the least about it!

Each room or group of rooms is named on the Taskmaster Base Map at the end of this section. The function of most rooms is self-evident. However, information is provided about many of the areas in this section.

Taskmaster Base

Barracks: These rooms are filled with two-tier bunkbeds and military-style footlockers. Racked at the foot of each bunk are two automatic rifles, cleaned and loaded. The beds are all made to precision. The footlockers are filled with personal items and olive drab coveralls. None of it is informative or useful.

Business office: This is the office from which Taskmaster conducts business with outsiders (super villains looking for muscle). It is well-furnished and fitted with a number of automatic devices.

An X-ray scanner is mounted in the doorframe with the viewer behind the desk. The door is made of vibranium. At the desk are controls which flood the room with sleeping gas, turn out the lights, and fire the stunnulators hidden in the ceiling. These are aimed on the visitor's half of the room. In the wall behind the desk are two sliding panels. One opens onto Taskmaster's express elevator (leading to the hangar) and the other is a passage to the Command Center.

Command Center: This is the master control center of the complex. From here any room can be flooded with sleeping gas at the flip of a switch. The control for the automatic destruct sequence is located here. The monitor can call up the scene on any surveillance camera and mike. There is radio equipment with pre-set frequencies connecting to the other training academies throughout the United States. There are also complete controls for the interior services of the complex - lights, air, power. A Reason FEAT roll is required to find any particular switch on the various control panels. In the walls are two secret openings. One leads to the Business Office and the other to the Laboratory. There is one goon here, armed with a special weapon.

Laboratory: This is a complete scientific laboratory (as per the room package). There is a great deal of useful equipment located here. In the room are five scientists and technicians. If Professor Humble has been kidnapped, he is in this room.

Medical Center: This is a complete medical package. There are two technician-specialists (surgeons) here.

Dojo: This is the martial arts training hall. It is used for most combat training exercises. In the room are eight of Taskmaster's goons.

Firing Range: There are two goons here. Each is armed with a fully-loaded automatic rifle.

Gymnasium: Four goons are here with Taskmaster. If the Anti-Hero Squad is still at large, they are here, too. Taskmaster and the Squad let the goons do the fighting while they attempt to reach the Command Center. If attacked, Taskmaster orders the Squad into action while he escapes. Taskmaster has no intention of being caught, having long ago learned the value of running away.

Hangar: Located here is Taskmaster's specially designed jet. It is in all ways equal to a Quinjet. Hydraulic hatches open into the backyard of Mrs. Morgan's, providing a vertical take-off for the jet. It is always fueled and ready for instant flight.

Surveillance Center: This room is

connected to the Command Center. The walls are covered with monitors, each showing a different section of the compound or the house above. A bank of buttons allows sound to be cut in or out. There is one goon here.

Workshop: This is a complete high-technology workshop, allowing Taskmaster's science team to create nearly any item he needs. There are eight technicians present. They are putting the finishing touches on a large machine. If the player characters study the item, but have not seen the plans for Professor Humble's failed telepathy device (which is sitting on a bench in the corner), a Reason FEAT roll tells them that it is some type of mental augmentor and that it is connected to the communications network of the Command Center. If captured, the technicians fearfully explain the purpose of the device and what they know of Taskmaster's plans. With a little study, those who are familiar with Humble's device are able to recognize this as a larger version.

The device is a larger version of the machine Humble designed. This one is capable of operating on a city-wide scale. Taskmaster has been gearing up for a test run. If successful, he was going to either use it for his own purposes or sell it to the highest bidder. He has not reached a final decision, but his dislike of active crime and his love of money are swaying him to the option of selling it.

Aftermath II

If the player characters survive the adventure, they have the satisfaction of knowing they have defeated a major villain (although he did get away). They have made a reputation for the AEF, one sure to attract other menaces out to prove their might. The AEF is a viable organization and will continue!

But if Taskmaster succeeded or the complex blew up, the player characters must bear the knowledge that they failed, perhaps at a horrible cost! And such a failure on their first mission is more than the Avengers can overlook. It is obvious to them that this group simply does not have what it takes to be Avengers. The AEF is disbanded and the entire project shelved.

No matter what happens to the AEF, the local authorities and press remember what the player characters did. If they were successful, this only works to their advantage. However, if they failed or caused such horrible destruction, their names and reputations are besmirched forever. Such is the great risk of being a super hero!

Taskmaster Base Map

First Level

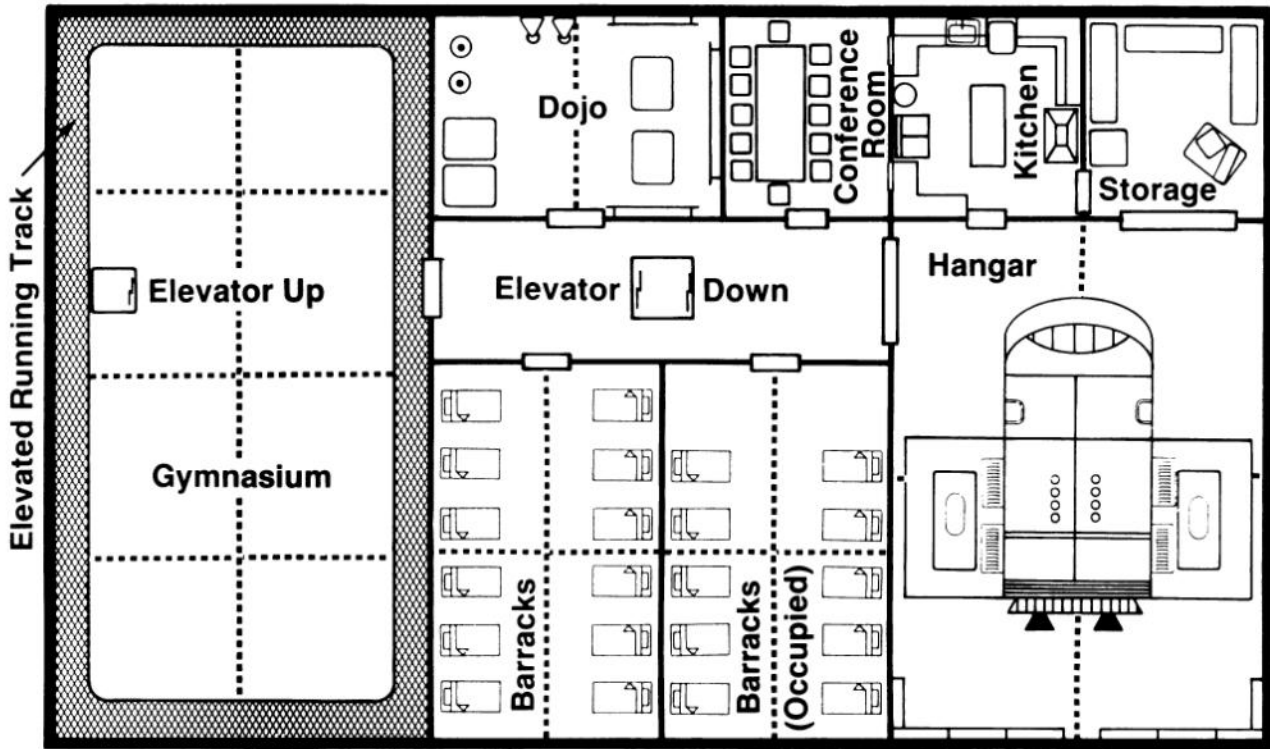

Second Level

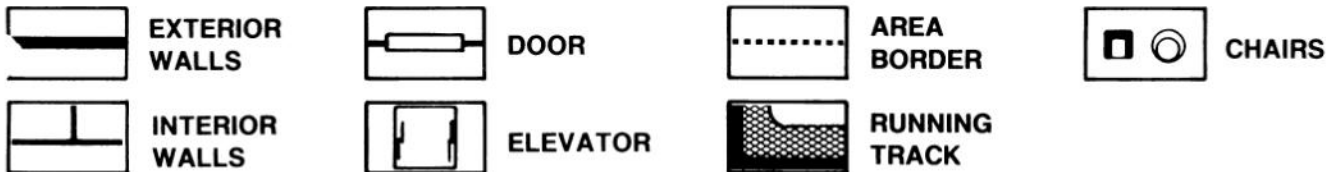
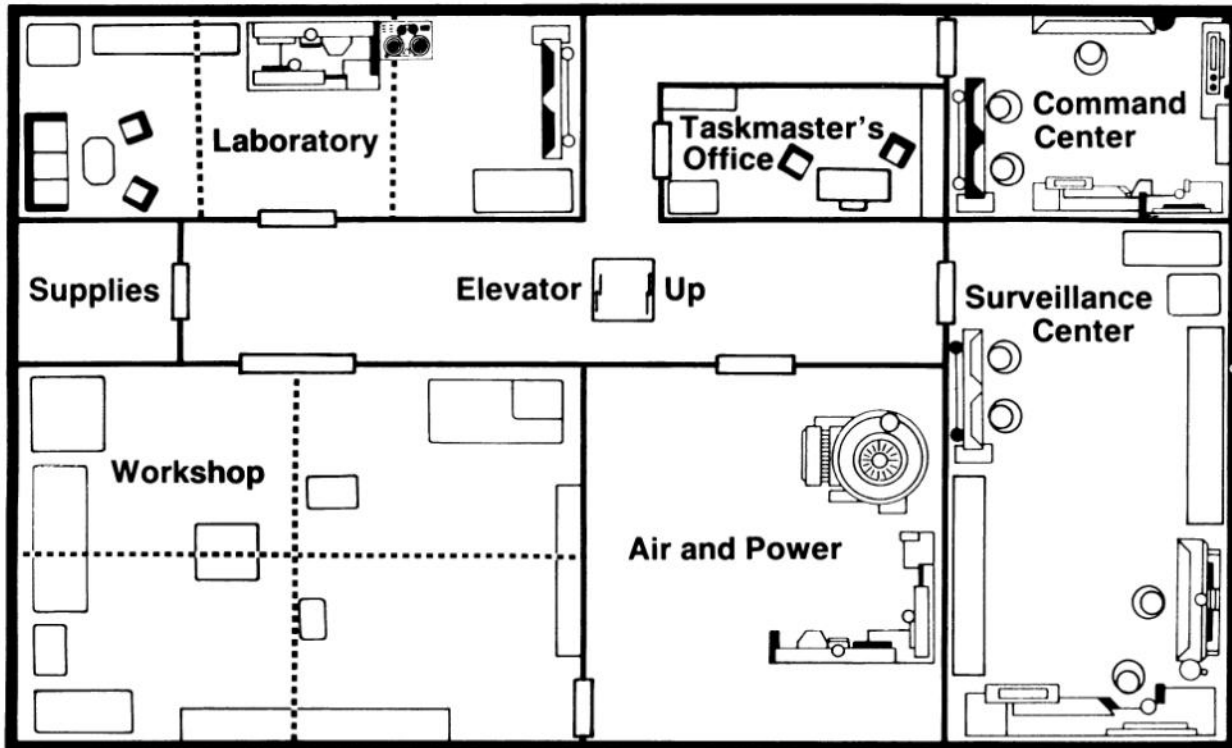

This book is protected under the copyright laws of the United States of America. Any reproduction or other unauthorized use of the material or artwork contained herein is prohibited without the express written consent of TSR Inc. and Marvel Comics Group. Distributed to the book trade in the United States by Random House Inc. and in Canada by Random House of Canada, Ltd. Distributed to the toy and hobby trade by regional distributors.

The names of characters used herein are fictitious and do not refer to any persons living or dead. Any descriptions including similarity to persons living or dead are merely coincidental. All Marvel characters and the distinctive likenesses thereof are trademarks of Marvel Comics Group.

MARVEL SUPER HEROES, MARVEL SUPER VILLAINS, AVENGERS, IRON MAN, THOR, WASP, HULK, ANT-MAN, HENRY PETER GYRICH, RAYMOND SIKORSKY, X-MEN, MARIA STARK FOUNDATION, HOWARD STARK, WONDER MAN, TIGRA, HENRY PYM, HAWKEYE, MOCKINGBIRD, ANT-MAN I, GIANT-MAN I, GOLIATH I, YELLOWJACKET I, JANET VAN DYNE, EGGHEAD, ULTRON, JOCASTA, BEAST, HENRY McCOY, SCARLET WITCH, VISION, MANTIS, SWORDSMAN, BLACK KNIGHT, DANE WHITMAN, KANG, SIR PERCY OF SCANDIA, BLACK PANTHER, T'CHALLA, KING OF WAKANDA, CAPTAIN AMERICA, FALCON, BLACK WIDOW, NATASHA ROMANOVA, S.H.I.E.L.D., CHAMPIONS OF LOS ANGELES, HAWKEYE, DAREDEVIL, SAM WILSON, REDWING, RED SKULL, GOLIATH II, CLINT FRANCIS BARTON, ROBERT BRUCE BANNER, RICK JONES, HELLCAT, PATSY WALKER, MOONDRAGON, DAIMON HELLSTROM, GREER NELSON, THE DEFENDERS, ANTHONY STARK, JAMES R. RHODES, STARK INTERNATIONAL, NICK FURY, HEATHER DOUGLAS, TITAN, ODIN, MS. MARVEL, CAROL SUSAN DANVERS, CAPTAIN MAR-VELL, COLONEL YON-ROGG, MARCUS, IMMORTUS, PROFESSOR X, BINARY, QUICKSILVER, PIETRO MAXIMOFF, CRYSTAL THE INHUMAN, NORM WEBSTER, WANDA, CHTHON, AGATHA HARKNESS, DOCTOR STRANGE, MAGNETO, HOLLY LADONNA, GLYNIS ZARKOV, ILYA ZARKOV, GLAMOR, ILLUSION, DJANGO MAXIMOFF, FIRST BROTHERHOOD OF EVIL MUTANTS, STARFOX, EROS OF TITAN, THOR OF ASGARD, PHINIAS T. NORTON, HUMAN TORCH, EDWIN JARVIS, KREE SUPREME INTELLIGENCE, SCOTT EDWARD LANG, MAR-VELL OF THE KREE, DRAX THE DESTROYER, ARTHUR DOUGLAS, FIREBIRD, BONITA JUAREZ, THANOS, GHOST RIDER, HAMILTON SLADE, MENTOR, ALARS OF TITAN, PALADIN, WILL TALLTREES, SHOOTING STAR, VICTORIA STAR, TEXAS TWISTER, DREW DANIELS, FABIAN STANKOWICZ, KORVAC, MICHAEL, THE ENEMY, CARINA, COLLECTOR, GUARDIANS OF THE GALAXY, RONAN, EMPEROR DORREK, H. WARREN CRADDOCK, SUPER-SKRULL, THE INHUMANS, THE KREE-SKRULL WAR, LETHAL LEGION I, GRIM REAPER, LIVING LASER, MAN-APE, LETHAL LEGION II, ULTRON-12, NEKRA, MASTERS OF EVIL I, BARON HEINRICH ZEMO, EXECUTIONER, MELTER, RADIOACTIVE MAN, MASTERS OF EVIL II, ULTRON-5, CRIMSON COWL, KLAW, WHIRLWIND, BEETLE, SCORPION, SHOCKER, TIGER SHARK, J. JONAH JAMESON, ABSORBING MAN, BLACKOUT, GREY GARGOYLE, MR. HYDE, SCREAMING MIMI, TITANIA, WRECKING CREW, COBRA, BLOOD-BROTHER, CONTROLLER, AIRES, ARIES OF OLYMPUS, ARMADILLO, ANTONIO RODRIGUEZ, DR. KARL MALUS, ARNIM ZOLA, ATTUMA, PRINCE NAMOR, SUB-MARINER, ALPHA FLIGHT, TRAPSTER, PRIMUS, MOTHER SUPERIOR, MASTER OF EVIL, NATHAN GARRETT, MARCUS DANIELS, DR. ABNER CROIT, BLACK TALON, TANELEER TIVAN, BASIL SANDHURST, DEATHURGE, ELIHAS STARR, TRISH STARR, TASKMASTER, DR. TORRENCE HUMBLE, HERCULES, ?, AVENGERS EXPERIMENTAL FRANCHISE, RINGMASTER, STRIKEBUSTER, DAZZLER, KA-ZAR, NAMORITA, NOMAD, POWER MAN, QUASAR, RED WOLF, STINGRAY, ANNIHILUS, SPINNER, BOBCAT, METALLUS, ROBO-TASKMASTER, SHADOW, LE DOREAN BATTLESUIT, MARK I ARMOR, MARK II ARMOR, MARK III ARMOR, MARK IV ARMOR, BYRON J. GAMBLE, PSEUDO-MANDROIDS, JACOB REDWING, MRS. MORGAN, CYBERSQUAD, AVENGERS EXPERIMENTAL FRANCHISE, LATVERIA, DREADKNIGHT, PROJECT PEGASUS, BUCKY BARNES and the distinctive likenesses thereof are trademarks of the Marvel Comics Group, copyright ©1986 Marvel Comics Group, a division of Cadence Industries Corporation. All Rights Reserved. Printed in the U.S.A. Game Design Copyright ©1986 TSR Inc. All Rights Reserved.

HAWKEYE'S SKYMOBILE

WEIGHT (UNLOADED, INCL. FUEL): 680 LBS.
 MAXIMUM CARGO: 450 LBS.
 FLIGHT RADIUS: 270 MILES
 MAX. LEVEL AIRSPEED (SEA LEVEL): 380 M.P.H.
 SERVICE CEILING: 12,000 FEET
 MAX. RATE OF CLIMB: 800 FEET PER SECOND

DESIGNED BY JORGE LATHAM AND BUILT AT
 CROSS TECHNOLOGICAL ENTERPRISES

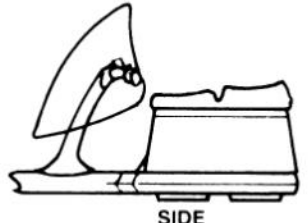
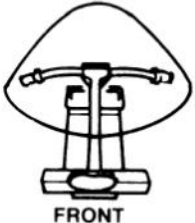
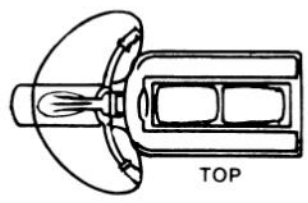
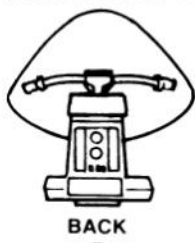
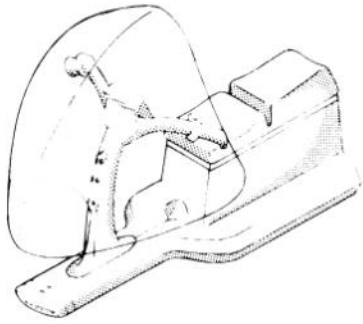
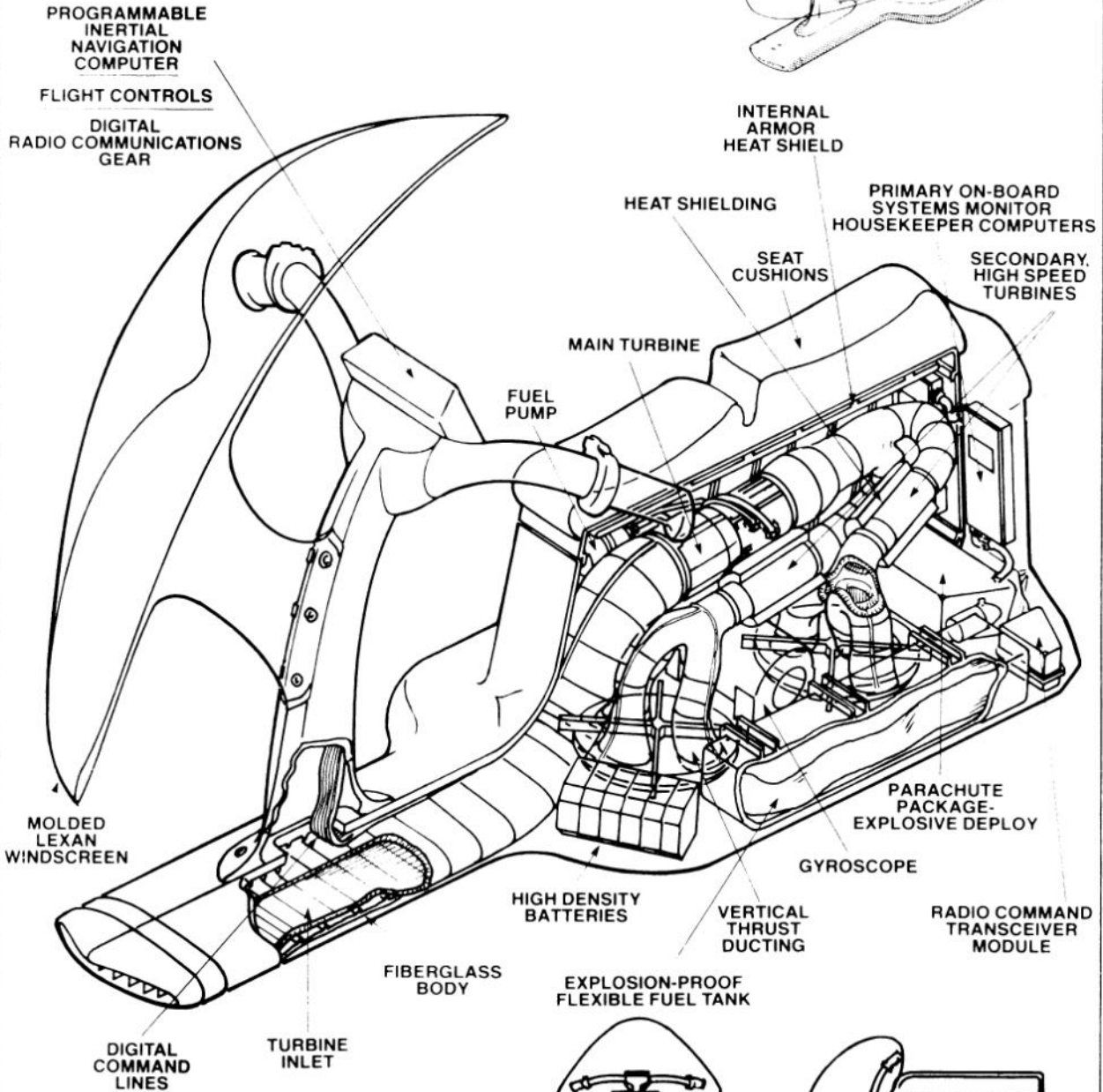

MARVEL SUPER HEROES™

Official Advanced Game Accessory

AVENGERS™ COAST-TO-COAST

by Edward G. Sollers
Adventure by David Cook

Earth's Mightiest Heroes™—only the Avengers can lay claim to that proud title. They have fought the deadliest villains ever to imperil the Earth, and their adventures have spanned the limits of the Marvel Universe™. *Avengers Coast-to-Coast* is a sourcebook that enables you to create grand new adventures for the Avengers, or to relive their great adventures of the past.

New exciting information abounds within. The Avengers Charter, detailed descriptions of both mansions and their formidable defenses, new information on security clearances and procedure, full details of the amazing Quinjets™ are included. The roster section includes the Avengers not in the MARVEL SUPER HEROES™ Advanced Set (plus some updates), their allies, such as Captain Mar-Vell™ Mentor™, and Firebird™, and a host of villains. These unsavory types include your old favorites, like Kang™, Ultron™, and all the Masters of Evil™ (with more than ever on each), as well as new ones, such as Thanos™, the Squadron Sinister™, and the deadly Scourge™. A 24-page adventure allows you to set up your own player characters as an Avengers expansion team! It's greatness, as only Marvel Comics and TSR can do it!

This game accessory is designed for use with the MARVEL SUPER HEROES™ Advanced Set. It is a 96-page book, with expanded information on the Avengers, a 24-page adventure, and a roster of Avengers and their foes.



TSR Inc.
POB 756
Lake Geneva,
WI 53147

6874XXX 1401
0-88038-293-7
\$12.00

